

MYLUXURY

PRICE LIST



INDICE

ORNAMENTI	PAG. 7 – 19
RILIEVI	PAG. 21 – 33
CAPITONNÈ	PAG. 35 – 47
DECORATI	PAG. 49 – 61
MOBILI	PAG. 63 – 75
FREGI	PAG. 77 – 89
INTARSIO FREGI	PAG. 91 – 103
INTARSIO	PAG. 105 – 117
KNOB & HANDLES	PAG. 118
APPLIQUES & LAMPS	PAG. 119
STANDARD FEATURES FURNITURE FINISHES –	
CONSOLLE – CABINET – MIRRORS	PAG. 120 - 121
STANDARD FEATURES ARREDO	PAG. 122
FITTING & FASTERING FURNITURES -CABINETS-	
MIRRORS- FRAMES-APPLIQUES-LAMPS-RADIATORS-	
ACCESSORIES- BOISERIE	PAG. 123
DRAIN HOLE SINK TO MOUNT THE SIPHON	
PASTELLI FINISH	PAG. 124
HOW TO CREATE AN ORDER	PAG. 125
GENERAL SALES CONDITION	PAG. 126 - 127

HOW TO READ OUR CATALOGUE AND PRICE-LIST

Follow the instructions below to download our catalogue and price-list from our website

1) Here you will find the .pdf version :

- www.iltempodel.it
- Click on menu cataloghi (on the right)
- download catalogue PDF
- Download price-list PDF

Here you find the last upgraded versions

2) Each catalogue has divided in different collections indicated on cover and in the first page of the collection , ex.: Trendy Deluxe includes: *Componibile, Capitonè, Fregi, Mobili, Consolle e Decorati* ; each collection is composed by different models with different sizes and finishes.

3) how can i calculate the composition's quote ?

- choose the composition on our catalogue (es : **Trendy Deluxe** -> Serie **Mobili** -> base **TD 262 PT BI** / cornice **CR 650 FOOR**)
- on the left page of the catalogue you find the corresponding page for price-list



iii. On the page of chosen furniture you can choose between different sizes and shapes of the same model and you create your personal composition choosing : top, washbasin, mirror ...
 Proceed with the sum of **code** that you find on the top of each chosen element

CORE

From the first section choose the CORE considering drawers, doors and sizes.

TOP

Choose the TOP: Crystal, Marble (and it's washbasin) or Ceramic where is available.

MIRROR

Choose mirror (SP code) or a frame from ARREDO catalogue match it with the furniture size.

COMPLEMENTS

Each collection has it's own complements like windows, pettineuse or pouf made with the same finishes of the furniture

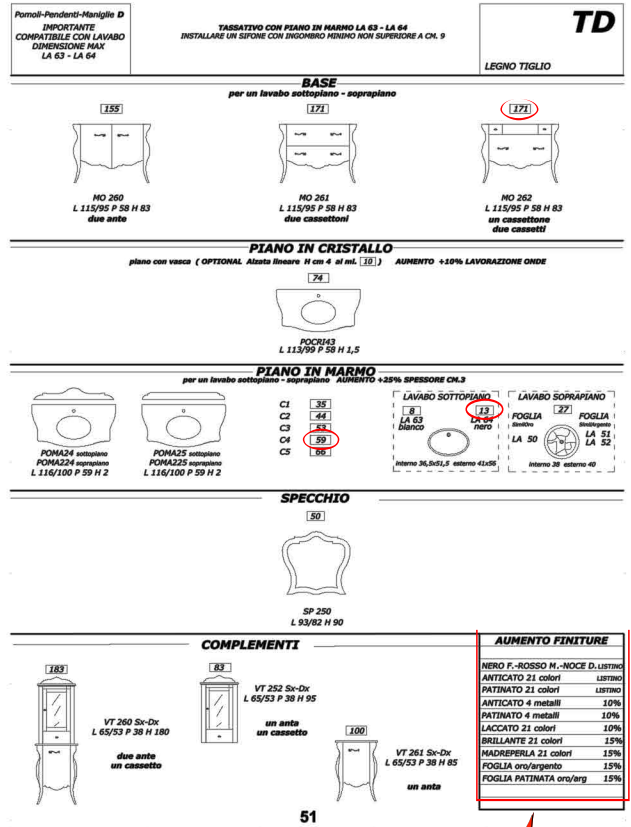

The box you find on the right indicate the possible finishes for this collection and the relative price increase you have to add in % only for wood part (not for washbasin, top..)

On ARREDO I price code are indicated close to the pictures inside the white rectangle , and in the end of the same page you find the possible finishes

QUOTE EXEMPLE

QUOTE FOR COMPOSITION : TD 262 PT BI / CR 650 FOOR as in the catalogue

core (without increase for PATINATO because % is the same of price-list)	171 +
marble top C4 NEGRO SEPIA LL (Arredo -> Marmi):	59 +
undertop washbasin	13 +
frame (from ARREDO)	52 +
Appliques	2*14 +
	TOTAL 323

To convert in EURO from **CODE** ask the coefficient to the zone seller or in case you don't find it contact us :

ORNAMENTI

Knob T
color and finish as furniture

IMPORTANT
COMPATIBLE WITH
WASHBASIN OF MAX SIZE
LA 63 - LA 64

PEREMPTORY 1°COLOR INTERNAL AND EXTERNAL OF DOORS , DRAWERS , BIG DRAWERS AND MIRROR.
BICOLOR 2°COLOR INTERNAL AND EXTERNAL OF FURNITURE STRUCTURE - CABINET.

ON DEMAND BICOLOR WITH THE SAME FINISH
PRICE LIST WITH INCREASE FOR THE CHOICE FINISH

ON DEMAND BICOLOR WITH TWO DIFFERENT FINISHES
PRICE LIST WITH INCREASE CALCULATED ON THE HIGHER INCREASE CHOOSEN FINISH

UNDERTOP WASHBASIN		OVERTOP WASHBASIN	
8 LA 63 WHITE		13 LA 64 BLACK	27 FOGLIA Similgold LA 50
internal 36,5x51,5 external 41x56		internal 38 external 40	

PEREMPTORY WITH MARBLE TOP LA 63 - LA 64
INSTALL SIPHON WITH OVERALL LESS THAN CM. 9

CORE

for one or two undertop-overtop washbasin

150 Increase brushed ornamenti 5 	247 Increase brushed ornamenti 10 	317 Increase brushed ornamenti 10 	290 Increase brushed ornamenti 10 	431 Increase brushed ornamenti 15 	403 Increase brushed ornamenti 15
MO 2311 L 130/110 P 64 H 83 one big drawer	MO 2375 L 132/119 P 56 H 83 one big drawer	MO 2376 L 132/119 P 56 H 83 one big drawer four drawers	MO 2377 L 132/119 P 56 H 83 two big drawers	MO 2378 one washbasin L 185/172 P 63 H 83 one big drawer four drawers	MO 2379 two washbasins L 185/172 P 63 H 83 one big drawer two drawers

CRYSTAL TOP

with washbasin INCREASE +10% WAVE MANUFACTURE - OPTIONAL linear riser h 4 cm linear meter 10 or shaped riser h 10 cm linear meter 15

80 	76 	97 	123
POCRI93 L 133/113 P 66 H 1,5	POCRI90 L 121/89 P 57 H 1,5	POCRI91 L 174/146 P 65 H 1,5	POCRI92 L 174/146 P 65 H 1,5

MARBLE TOP

for one or two undertop - overtop washbasin INCREASE +25% THICKNESS CM.3

<p>POMA175 undertop POMA275 overtop L 135/115 P 67 H 2</p> <p>C1 39 C2 48 C3 59 C4 65 C5 73</p>	<p>POMA160 undertop POMA260 overtop L 123/91 P 58 H 2</p> <p>C1 35 C2 44 C3 54 C4 59 C5 66</p>	<p>POMA161 for 1 undertop POMA261 for 1 overtop POMA162 for 2 undertops POMA262 for 2 overtops L 177/148 P 65 H 2</p>	<p>POMA184 for 1 undertop POMA284 for 1 overtop POMA186 for 2 undertops POMA286 for 2 overtops L 177/148 P 65 H 2</p> <p>C1 52 C2 64 C3 79 C4 87 C5 97</p>
---	--	---	--

MIRRORS

52 Increase brushed ornamenti 5 	50 Increase brushed ornamenti 5 	66 Increase brushed ornamenti 5 	83 Increase brushed ornamenti 5
SP 2375 L 115/92 H 108	SP 250 L 93/82 H 90	SP 2378 L 175/150 H 108	SP 267 L 150/140 H 90

ACCESORIES

<p>10 Increase brushed ornamenti</p> <p>252 VT 2375 Sx-Dx L 70/62 P 38 H 180 one door one drawer one big drawer</p>	<p>10 Increase brushed ornamenti</p> <p>424 VT 2377 L 132/119 P 38 H 180 two doors two big drawers</p>	<p>Increase brushed ornamenti 10</p> <p>292 VT 2378 L 132/119 P 38 H 85 two big drawers</p> <p>Increase brushed ornamenti 6</p> <p>148 VT 2376 L 70/53 P 38 H 85 one big drawer</p>
--	---	---

STANDARD ORNAMENTI SAME FINISH OF THE FURNITURE-MIRROR-CABINET **A PRICE LIST**
ON DEMAND BRUSHED ORNAMENTI ONE COLOR & BICOLOR IN 21 COLORS AND 4 METAL COLORS FOR ALL FINISHES **WITH INCREASE**

ORNAMENTI

MY

INTERNAL BOTTOM DRAWER - BIG DRAWER AND DOOR 'S COATING
STANDARD LACE AND ECO-LEATHER CORD SAME AS THE FINISHES HANDLES **OR/CO/BR**
ON DEMAND CHOOSE COLOR LACE OR ECOLEATHER AND CORD ECOLEATHER **A PRICE LIST**

LINDEN WOOD

MAKEUP CORE central

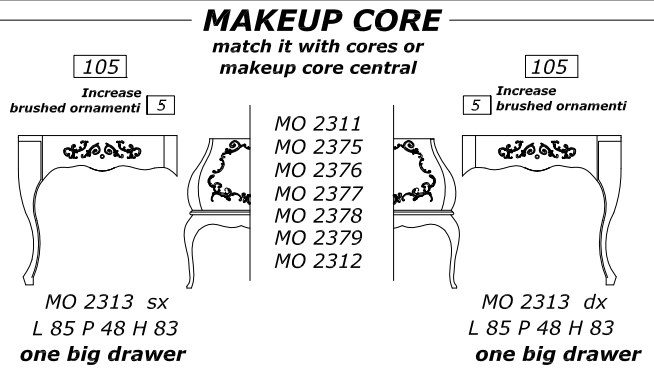
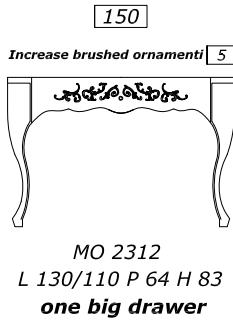

WOOD TOP

CRYSTAL TOP

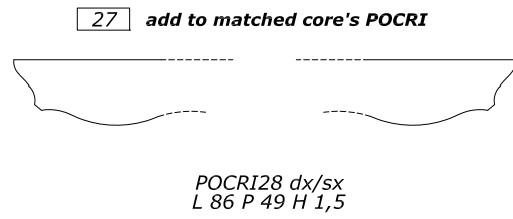
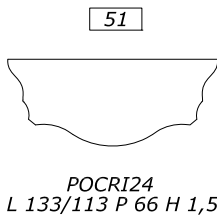
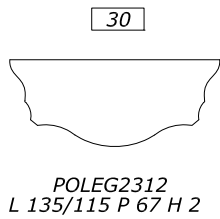

INCREASE +10% WAVE MANUFACTURE -
OPTIONAL linear riser h 4 cm linear meter 10 or shaped rider h 10 cm linear meter 15 MAX LENGTH 2,25ml

MARBLE TOP

INCREASE +25% THICKNESS CM.3 MAX LENGTH L 2,25 ml

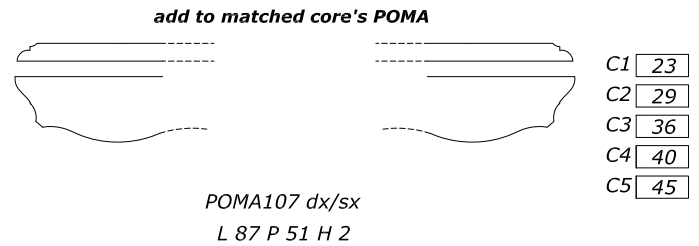
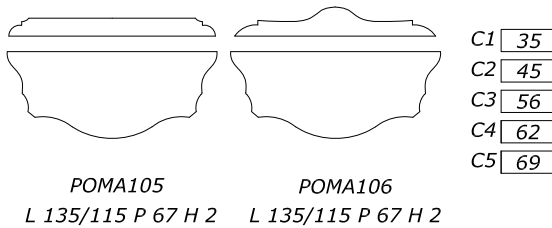

MIRRORS

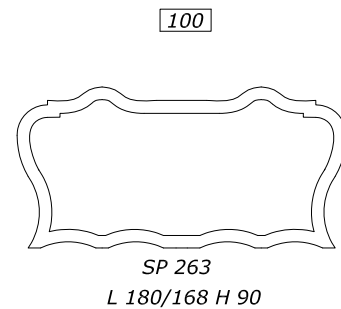
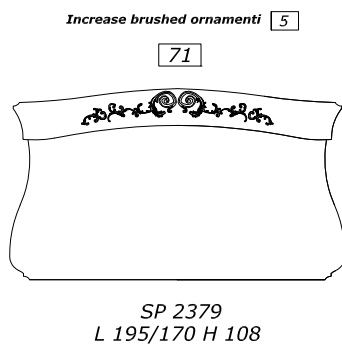

ACCESSORIES

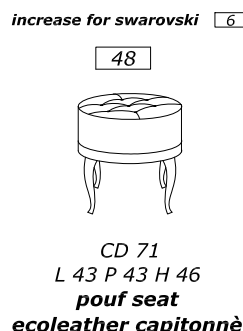
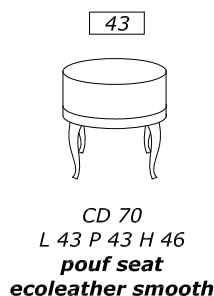
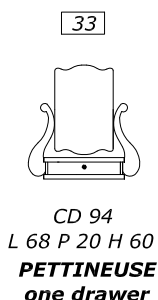

FINISH'S INCREASE
ONECOLOR-BICOLOR

ANTICATO 21 colors	PRICE LIST
PATINATO 21 colors	PRICE LIST
ANTICATO 4 metals	10%
PATINATO 4 metals	10%
LACCATO 21 colors	10%
BRILLANTE 21 colors	20%
MADREPERLA 21 colors	20%

Knob T
color and finish as furniture

IMPORTANT
COMPATIBLE WITH
WASHBASIN OF MAX SIZE
LA 63 - LA 64

PEREMPTORY 1°COLOR INTERNAL AND EXTERNAL OF DOORS , DRAWERS , BIG DRAWERS AND MIRROR.
BICOLOR 2°COLOR INTERNAL AND EXTERNAL OF FURNITURE STRUCTURE - CABINET.

ON DEMAND BICOLOR WITH THE SAME FINISH
PRICE LIST WITH INCREASE FOR THE CHOICE FINISH

ON DEMAND BICOLOR WITH TWO DIFFERENT FINISHES
PRICE LIST WITH INCREASE CALCULATED ON THE HIGHER INCREASE CHOSEN FINISH

UNDERTOP WASHBASIN		OVERTOP WASHBASIN	
8 LA 63 WHITE		13 LA 64 BLACK	
internal 36,5x51,5 esternal 41x56		internal 38 esternal 40	
PEREMPTORY WITH MARBLE TOP LA 63 - LA 64			
INSTALL SIPHON WITH OVERALL LESS THAN CM. 9			

CORE

for one or two undertop - overtop washbasin

150 Increase brushed ornamenti 5 MO 2311 L 130/110 P 64 H 83 one big drawer	269 Increase brushed ornamenti 10 MO 2380 L 132/110 P 60 H 82 two doors two drawers	312 Increase brushed ornamenti 10 MO 2381 L 132/110 P 60 H 82 two big drawers two drawers	368 Increase brushed ornamenti 15 MO 2382 L 176/152 P 60 H 82 two doors three drawers
--	--	--	--

CRYSTAL TOP

with washbasin INCREASE +10% WAVE MANUFACTURE - OPTIONAL linear riser h 4 cm linear meter 10 or shaped riser h 10 cm linear meter 15

80 POCRI93 L 133/115 P 66 H 1,5	76 POCRI40 L 123/104 P 59 H 1,5	92 POCRI41 L 166/148 P 59 H 1,5	123 POCRI42 L 166/148 P 59 H 1,5
---	---	---	--

MARBLE TOP

for one or two undertop - overtop washbasin INCREASE +25% THICKNESS CM.3

<p>POMA175 undertop POMA275 overtop L 135/115 P 67 H 2</p> <p>C1 39 C2 48 C3 59</p> <p>POMA176 undertop POMA276 overtop L 135/115 P 67 H 2</p> <p>C4 65 C5 73</p>	<p>POMA194 undertop POMA294 overtop L 124/105 P 59 H 2</p> <p>C1 36 C2 45 C3 56</p> <p>POMA22 undertop POMA222 overtop L 124/105 P 59 H 2</p> <p>C4 61 C5 68</p>	<p>POMA195 for 1 undertop POMA295 for 1 overtop POMA196 for 2 undertops POMA296 for 2 overtops L 167/149 P 59 H 2</p>	<p>POMA12 for 1 undertop POMA212 for 1 overtop POMA63 for 2 undertops POMA263 for 2 overtops L 167/149 P 59 H 2</p> <p>C1 50 C2 62 C3 76 C4 83 C5 93</p>
---	--	---	--

MIRRORS

52 Increase brushed ornamenti 5 SP 2375 L 115/92 H 108	50 SP 250 L 93/82 H 90	66 Increase brushed ornamenti 5 SP 2378 L 175/150 H 108	83 SP 267 L 150/140 H 90
---	----------------------------------	--	------------------------------------

ACCESSORIES

<p>10 Increase brushed ornamenti</p> <p>252 VT 2380 Sx-Dx L 71/53 P 38 H 180 two doors two drawers</p>	<p>10 Increase brushed ornamenti</p> <p>442 VT 2382 L 132/119 P 38 H 180 two doors two drawers two big drawers</p>	<p>Increase brushed ornamenti 10</p> <p>314 VT 2383 L 132/119 P 38 H 85 two big drawers two drawers</p> <p>Increase brushed ornamenti 6</p> <p>148 VT 2381 Sx - Dx L 71/53 P 38 H 85 one door one drawer</p>
---	---	--

STANDARD ORNAMENTI SAME FINISH OF THE FURNITURE-MIRROR-CABINET **A PRICE LIST**
ON DEMAND BRUSHED ORNAMENTI ONE COLOR & BICOLOR IN 21 COLORS AND 4 METAL COLORS FOR ALL FINISHES **WITH INCREASE**

ORNAMENTI

MY

INTERNAL BOTTOM DRAWER - BIG DRAWER AND DOOR 'S COATING
STANDARD LACE AND ECO-LEATHER CORD SAME AS THE FINISHES HANDLES **OR/CO/BR**
ON DEMAND CHOOSE COLOR LACE OR ECOLEATHER AND CORD ECOLEATHER **A PRICE LIST**

LINDEN WOOD

MAKEUP CORE central

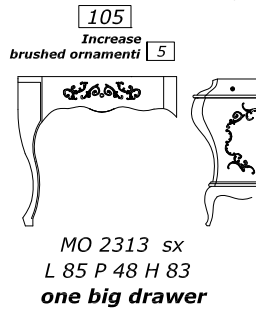
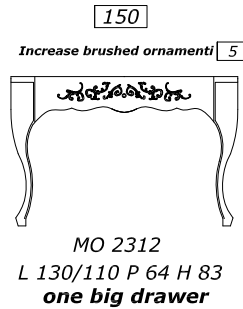

MO 2311
MO 2380
MO 2381
MO 2382
MO 2312

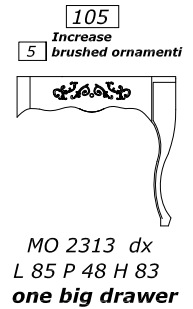

WOOD TOP

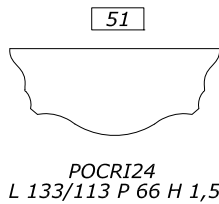
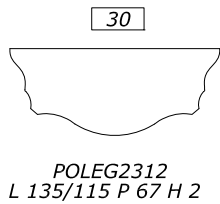

CRYSTAL TOP

INCREASE +10% WAVE MANUFACTURE -
OPTIONAL linear riser h 4 cm linear meter 10 or shaped rider h 10 cm linear meter 15 MAX LENGTH 2,25ml

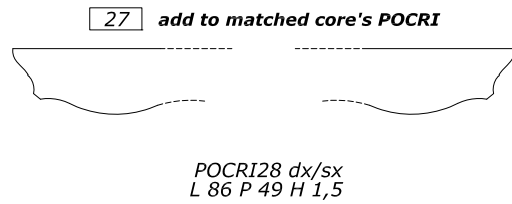

MARBLE TOP

INCREASE +25% THICKNESS CM.3 MAX LENGTH L 2,25 ml

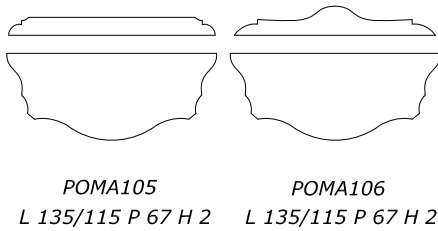

C1 35
C2 45
C3 56
C4 62
C5 69

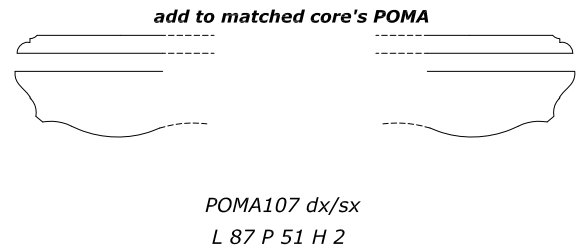

C1 23
C2 29
C3 36
C4 40
C5 45

MIRRORS

Increase brushed ornamenti 5

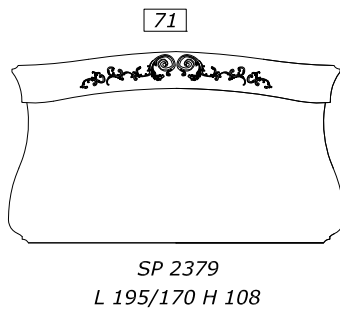

100

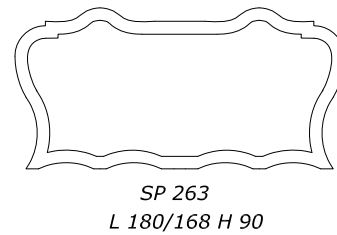

ACCESORIES

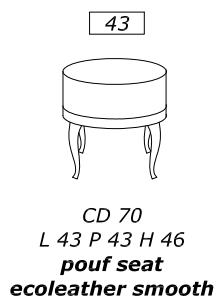
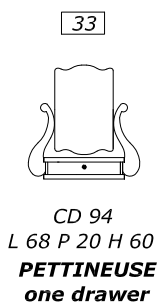

increase for swarovski 6

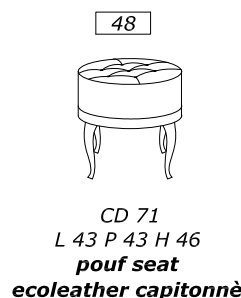

FINISH'S INCREASE
ONECOLOR-BICOLOR



ANTICATO 21 colors	PRICE LIST
PATINATO 21 colors	PRICE LIST
ANTICATO 4 metals	10%
PATINATO 4 metals	10%
LACCATO 21 colors	10%
BRILLANTE 21 colors	20%
MADREPERLA 21 colors	20%

Knob T
color and finish as furniture

IMPORTANT
COMPATIBLE WITH
WASHBASIN OF MAX SIZE
LA 63 - LA 64

PEREMPTORY 1°COLOR INTERNAL AND EXTERNAL OF DOORS, DRAWERS, BIG DRAWERS AND MIRROR.
BICOLOR 2°COLOR INTERNAL AND EXTERNAL OF FURNITURE STRUCTURE - CABINET.

ON DEMAND BICOLOR WITH THE SAME FINISH
PRICE LIST WITH INCREASE FOR THE CHOICE FINISH
ON DEMAND BICOLOR WITH TWO DIFFERENT FINISHES
PRICE LIST WITH INCREASE CALCULATED ON THE HIGHER INCREASE CHOSEN FINISH

UNDERTOP WASHBASIN		OVERTOP WASHBASIN	
8 LA 63 WHITE		13 LA 64 BLACK	
internal 36,5x51,5 external 41x56		internal 38 external 40	

PEREMPTORY WITH MARBLE TOP LA 63 - LA 64
INSTALL SIPHON WITH OVERALL LESS THAN CM. 9

CORE

for one undertop - overtop washbasin

202
Increase brushed ornamenti 10

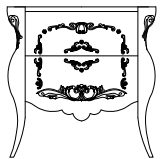

MO 2395
L 90/72 P 58 H 83
two big drawers

159
Increase brushed ornamenti 5

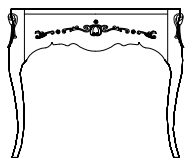

MO 2394
L 115/95 P 58 H 83
one big drawer

215
Increase brushed ornamenti 10

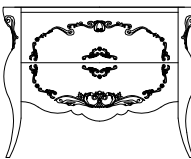

MO 2396
L 115/95 P 58 H 83
two big drawers

CRYSTAL TOP

with washbasin INCREASE +10% WAVE MANUFACTURE - OPTIONAL linear riser h 4 cm linear meter 10 or shaped riser h 10 cm linear meter 15

57

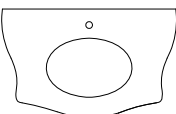

POCRI15
L 89/75 P 58 H 1,5

74

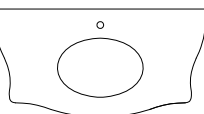

POCRI43
L 113/99 P 58 H 1,5

MARBLE TOP

for one undertop - overtop washbasin INCREASE +25% THICKNESS CM.3

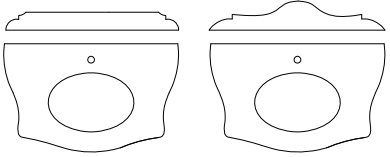

C1	27
C2	33
C3	41
C4	45
C5	50

POMA118 undertop
POMA218 overtop
L 91/77 P 59 H 2

POMA119 undertop
POMA219 overtop
L 91/77 P 59 H 2

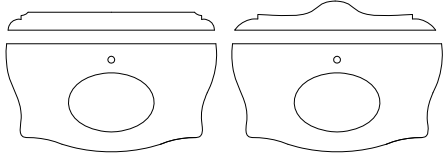

C1	35
C2	44
C3	53
C4	59
C5	66

POMA139 undertop
POMA239 overtop
L 116/100 P 59 H 2

POMA24 undertop
POMA224 overtop
L 116/100 P 59 H 2

MIRRORS

Increase brushed ornamenti 5

43



SP 2395
L 85/62 H 108

46

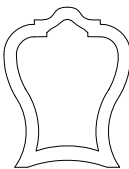

SP 252
L 71/60 H 90

Increase brushed ornamenti 5

46

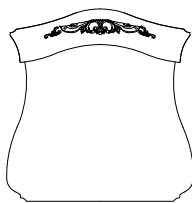

SP 2396
L 115/92 H 108

50

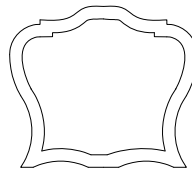

SP 250
L 93/82 H 90

ACCESORIES

10
Increase brushed ornamenti

227



VT 2395 Sx-Dx
L 65/53 P 38 H 180
two doors
one drawer

10
Increase brushed ornamenti

344

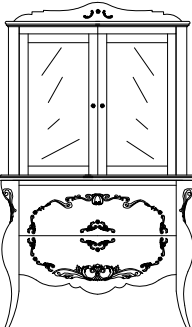

VT 2398
L 106/100 P 41 H 180
two doors
two big drawers

Increase brushed ornamenti 10

219

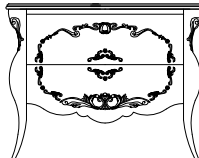

VT 2397
L 106/100 P 41 H 85
two big drawers

Increase brushed ornamenti 6

132



VT 2396 Sx-Dx
L 65/53 P 38 H 85
one door

STANDARD ORNAMENTI SAME FINISH OF THE FURNITURE-MIRROR-CABINET **A PRICE LIST**
ON DEMAND BRUSHED ORNAMENTI ONE COLOR & BICOLOR IN 21 COLORS AND 4 METAL COLORS FOR ALL FINISHES **WITH INCREASE**

ORNAMENTI **MY**

INTERNAL BOTTOM DRAWER - BIG DRAWER AND DOOR 'S COATING
STANDARD LACE AND ECO-LEATHER CORD SAME AS THE FINISHES HANDLES **OR/CO/BR**
ON DEMAND CHOOSE COLOR LACE OR ECOLEATHER AND CORD ECOLEATHER **A PRICE LIST**

LINDEN WOOD

MAKEUP CORE central

MAKEUP CORE

match it with cores or
makeup core central

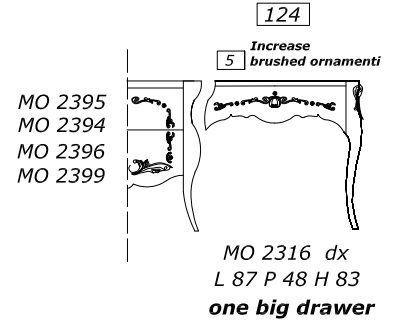
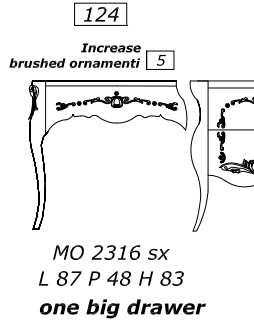
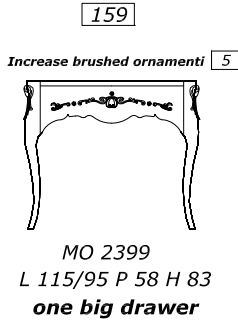

WOOD TOP

CRYSTAL TOP

INCREASE +10% WAVE MANUFACTURE -
OPTIONAL linear riser h 4 cm linear meter 10 or shaped rider h 10 cm linear meter 15 **MAX LENGTH 2,25ml**

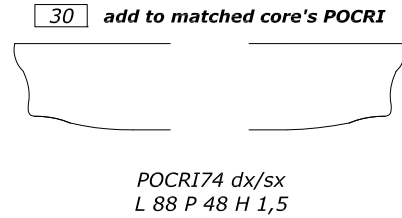
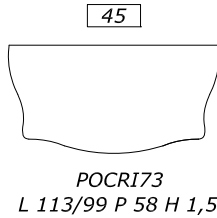
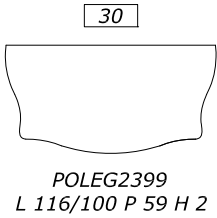

MARBLE TOP

INCREASE +25% THICKNESS CM.3 MAX LENGTH L 2,25 ml
add to matched core's POMA

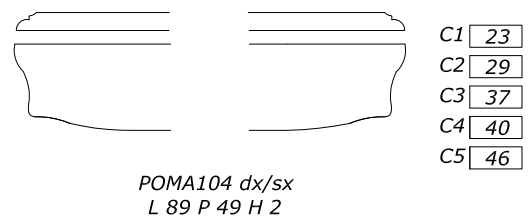
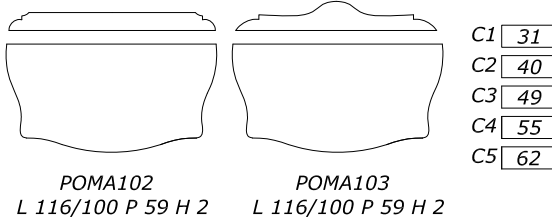

MIRRORS

Increase brushed ornamenti 5

Increase brushed ornamenti 5

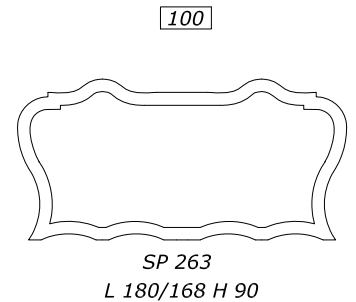
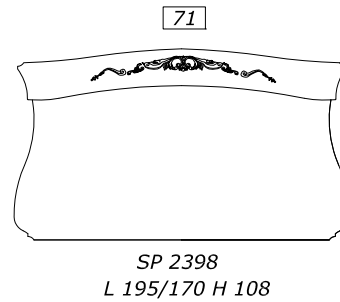
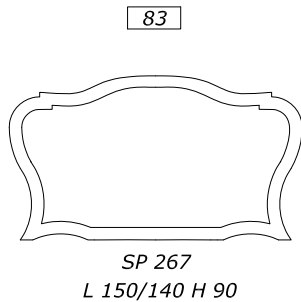
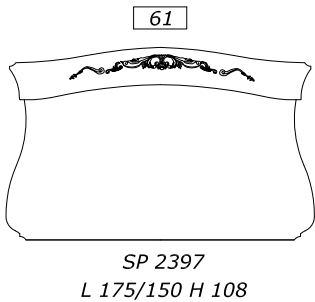

ACCESORIES

FINISH'S INCREASE
ONECOLOR-BICOLOR

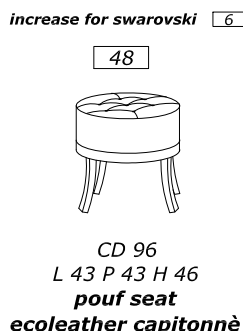
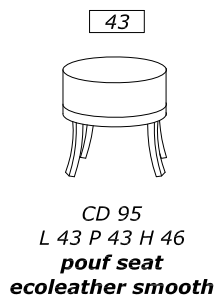
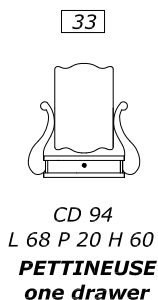

ANTICATO 21 colors	PRICE LIST
PATINATO 21 colors	PRICE LIST
ANTICATO 4 metals	10%
PATINATO 4 metals	10%
LACCATO 21 colors	10%
BRILLANTE 21 colors	20%
MADREPERLA 21 colors	20%

Knob T
color and finish as furniture

IMPORTANT
COMPATIBLE WITH
WASHBASIN OF MAX SIZE
LA 63 - LA 64

PEREMPTORY 1°COLOR INTERNAL AND EXTERNAL OF DOORS , DRAWERS , BIG DRAWERS AND MIRROR.
BICOLOR 2°COLOR INTERNAL AND EXTERNAL OF FURNITURE STRUCTURE - CABINET.

ON DEMAND BICOLOR WITH THE SAME FINISH
PRICE LIST WITH INCREASE FOR THE CHOICE FINISH
ON DEMAND BICOLOR WITH TWO DIFFERENT FINISHES
PRICE LIST WITH INCREASE CALCULATED ON THE HIGHER INCREASE CHOSEN FINISH

UNDERTOP WASHBASIN 8 LA 63 WHITE 13 LA 64 BLACK internal 36,5x51,5 external 41x56		OVERTOP WASHBASIN 27 FOGLIA Similgold LA 50 27 FOGLIA Similsilver LA 51 LA 52 internal 38 external 40	
---	--	---	--

PEREMPTORY WITH MARBLE TOP LA 63 - LA 64
INSTALL SIPHON WITH OVERALL LESS THAN CM. 9

CORE

for one or two undertop - overtop washbasin

282

Increase brushed ornamenti 15

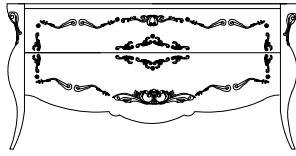

MO 2397
L 173/153 P 58 H 83
two big drawers

344

Increase brushed ornamenti 20

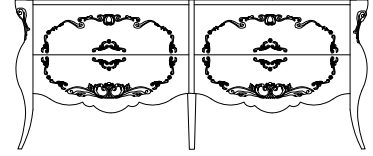

MO 2398
L 203/182 P 58 H 83
four big drawers

CRYSTAL TOP

with washbasin INCREASE +10% WAVE MANUFACTURE - OPTIONAL linear riser h 4 cm linear meter 10 or shaped riser h 10 cm linear meter 15

92

123

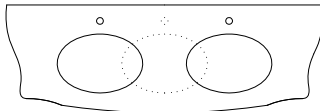

POCRI44 for 1 washbasin L 172/156 P 58 H 1,5
POCRI45 for 2 washbasins L 172/156 P 58 H 1,5

137

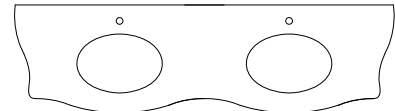

POCRI46
L 200/185 P 58 H 1,5

MARBLE TOP

for one undertop - overtop washbasin INCREASE +25% THICKNESS CM.3

POMA116 one undertop POMA115 two undertops
POMA216 one overtop POMA215 two overtops
L 173/157 P 59 H 2

- C1 51
- C2 63
- C3 79
- C4 86
- C5 97

POMA04 one undertop POMA02 two undertops
POMA204 one overtop POMA202 two overtops
L 173/157 P 59 H 2

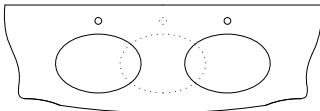

POMA117 undertop POMA217 overtop
L 202/186 P 59 H 2

- C1 62
- C2 76
- C3 94
- C4 103
- C5 115

POMA43 undertop POMA243 overtop
L 202/186 P 59 H 2

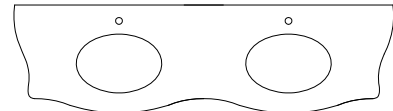

MIRRORS

Increase brushed ornamenti 5

61

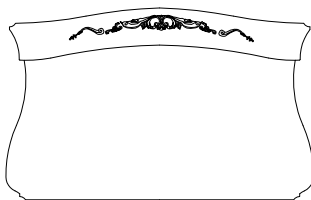

SP 2397
L 175/150 H 108

83

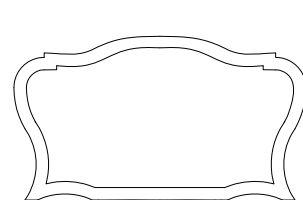

SP 267
L 150/140 H 90

ACCESSORIES

10
Increase brushed ornamenti

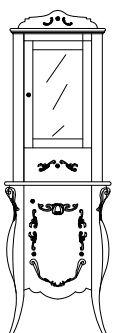

227
VT 2395 Sx-Dx
L 65/53 P 38 H 180
two doors
one drawer

10
Increase brushed ornamenti

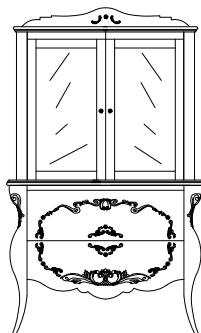

344
VT 2398
L 106/100 P 41 H 180
two doors
two big drawers

Increase brushed ornamenti 10

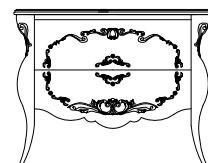

219
VT 2397
L 106/100 P 41 H 85
two big drawers

Increase brushed ornamenti 6

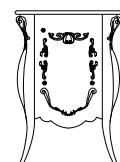

132
VT 2396 Sx-Dx
L 65/53 P 38 H 85
one door

STANDARD ORNAMENTI SAME FINISH OF THE FURNITURE-MIRROR-CABINET **A PRICE LIST**
ON DEMAND BRUSHED ORNAMENTI ONE COLOR & BICOLOR IN 21 COLORS AND 4 METAL COLORS FOR ALL FINISHES **WITH INCREASE**

ORNAMENTI

MY

INTERNAL BOTTOM DRAWER - BIG DRAWER AND DOOR 'S COATING
STANDARD LACE AND ECO-LEATHER CORD SAME AS THE FINISHES HANDLES **OR/CO/BR**
ON DEMAND CHOOSE COLOR LACE OR ECOLEATHER AND CORD ECOLEATHER **A PRICE LIST**

LINDEN WOOD

MAKEUP CORE central

MAKEUP CORE

match it with cores or
makeup core central

159

Increase brushed ornamenti 5

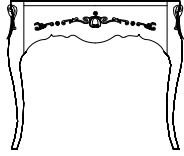

MO 2399
L 115/95 P 58 H 83
one big drawer

124

Increase brushed ornamenti 5

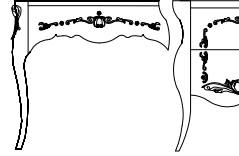

MO 2316 sx
L 87 P 48 H 83
one big drawer

124

Increase brushed ornamenti 5

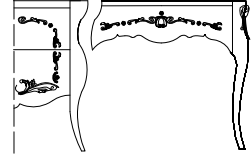

MO 2316 dx
L 87 P 48 H 83
one big drawer

MO 2397
MO 2398
MO 2399

WOOD TOP

CRYSTAL TOP

INCREASE +10% WAVE MANUFACTURE -
OPTIONAL linear riser h 4 cm linear meter 10 or shaped rider h 10 cm linear meter 15 MAX LENGTH 2,25ml

30

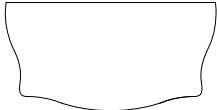

POLEG2399
L 116/100 P 59 H 2

45

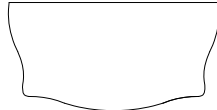

POCRI73
L 113/99 P 58 H 1,5

30

add to matched core's POCRI



POCRI74 dx/sx
L 88 P 48 H 1,5

MARBLE TOP

INCREASE +25% THICKNESS CM.3 MAX LENGTH L 2,25 ml

add to matched core's POMA

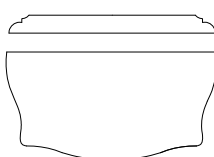

POMA102
L 116/100 P 59 H 2

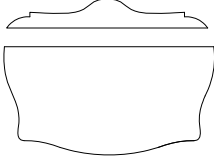

POMA103
L 116/100 P 59 H 2

- C1 31
- C2 40
- C3 49
- C4 55
- C5 62

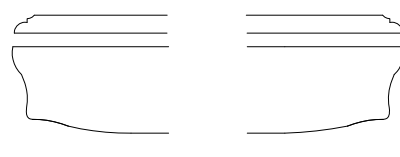

POMA104 dx/sx
L 89 P 49 H 2

- C1 23
- C2 29
- C3 37
- C4 40
- C5 46

MIRRORS

Increase brushed ornamenti 5

71

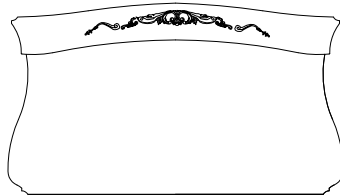

SP 2398
L 195/170 H 108

100

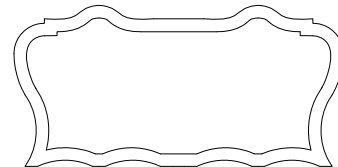

SP 263
L 180/168 H 90

ACCESSORIES

33

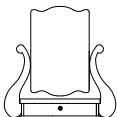

CD 94
L 68 P 20 H 60
PETTINEUSE
one drawer

43



CD 95
L 43 P 43 H 46
pouf seat
ecoleather smooth

48



CD 96
L 43 P 43 H 46
pouf seat
ecoleather capitoné

increase for swarovski 6

FINISH'S INCREASE
ONECOLOR-BICOLOR

ANTICATO 21 colors	PRICE LIST
PATINATO 21 colors	PRICE LIST
ANTICATO 4 metals	10%
PATINATO 4 metals	10%
LACCATO 21 colors	10%
BRILLANTE 21 colors	20%
MADREPERLA 21 colors	20%

Knob T
color and finish as furniture

IMPORTANT
COMPATIBLE WITH
WASHBASIN OF MAX SIZE
LA 63 - LA 64 - LA 03

PEREMPTORY 1°COLOR INTERNAL AND EXTERNAL OF DOORS, DRAWERS, BIG DRAWERS AND MIRROR.
BICOLOR 2°COLOR INTERNAL AND EXTERNAL OF FURNITURE STRUCTURE - CABINET.

ON DEMAND BICOLOR WITH THE SAME FINISH
PRICE LIST WITH INCREASE FOR THE CHOICE FINISH
ON DEMAND BICOLOR WITH TWO DIFFERENT FINISHES
PRICE LIST WITH INCREASE CALCULATED ON THE HIGHER INCREASE CHOOSEN FINISH

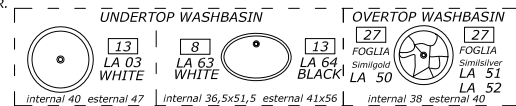

PEREMPTORY WITH MARBLE TOP LA 63 - LA 64
INSTALL SIPHON WITH OVERALL LESS THAN CM. 9

CORE

for one or two undertop - overtop washbasin

<p>120</p> <p>Increase brushed ornamenti 5</p> <p>MO 2383 L 106 P 50/37 H 83 one big drawer</p>	<p>135</p> <p>Increase brushed ornamenti 8</p> <p>MO 2384 L 63 P 52/37 H 83 one big drawer</p>	<p>135</p> <p>Increase brushed ornamenti 10</p> <p>MO 2385 L 84 P 50/37 H 83 one big drawer</p>	<p>144</p> <p>Increase brushed ornamenti 10</p> <p>MO 2386 L 104 P 50/37 H 83 one big drawer</p>	<p>334</p> <p>Increase brushed ornamenti 15</p> <p>MO 2387 L 190 P 50/37 H 83 two big drawewrs two drawers</p>
---	--	---	--	--

CERAMIC TOP

except of CORE MO 2383

CRYSTAL TOP

with washbasin INCREASE +10% WAVE MANUFACTURE -
OPTIONAL linear riser h 4 cm linear meter 10 or shaped riser h 10 cm linear meter 15

<p>23</p> <p>POCER11 L 59 P 52 H 4</p>	<p>29</p> <p>POCER10 L 89 P 55 H 4</p>	<p>34</p> <p>POCER12 L 109 P 55 H 4</p>	<p>53</p> <p>POCRI10 L 62 P 52 H 1,5 only one tap hole Sx - Dx</p>	<p>55</p> <p>POCRI49 L 82 P 52/39 H 1,5</p>	<p>63</p> <p>POCRI50 L 102 P 52/39 H 1,5</p>	<p>121</p> <p>POCRI51 L 187 P 52/39 H 1,5</p>
--	--	---	--	---	--	---

MARBLE TOP

for one undertop - overtop washbasin INCREASE +25% THICKNESS CM.3

<p>POMA170 undertop POMA270 overtop only one tap hole Sx - Dx L 62 P 52 H 2</p>	<p>POMA164 undertop POMA264 overtop only one tap hole Sx - Dx L 85 P 53/40 H 2</p>	<p>POMA165 undertop POMA265 overtop only one tap hole Sx - Dx L 105 P 53/40 H 2</p>	<p>POMA167 undertop POMA267 overtop only one tap hole Sx - Dx L 190 P 53/40 H 2</p>
<p>POMA52 undertop C1 19 POMA252 overtop C2 23 only one tap hole Sx - Dx C3 28 L 62 P 52 H 2 C4 30 C5 34</p>	<p>POMA92 undertop C1 26 POMA292 overtop C2 33 only one tap hole Sx - Dx C3 40 L 85 P 53/40 H 2 C4 44 C5 48</p>	<p>POMA93 undertop C1 32 POMA293 overtop C2 39 only one tap hole Sx - Dx C3 49 L 105 P 53/40 H 2 C4 53 C5 59</p>	<p>POMA97 undertop C1 58 POMA297 overtop C2 73 only one tap hole Sx - Dx C3 89 L 190 P 53/40 H 2 C4 97 C5 107</p>

MIRRORS

<p>Increase brushed ornamenti 5</p> <p>40</p> <p>SP 2384 L 63/40 H 108</p>	<p>46</p> <p>SP 252 L 71/60 H 90</p>	<p>43</p> <p>SP 2385 L 85/62 H 108</p>	<p>48</p> <p>SP 2386 L 105/82 H 108</p>	<p>50</p> <p>SP 250 L 93/82 H 90</p>
--	--	--	---	--

ACCESORIES

<p>Increase brushed ornamenti 10</p> <p>166</p> <p>VT 2385 Sx-Dx L 53 P 41 H 178 two doors one drawer</p>	<p>Increase brushed ornamenti 20</p> <p>320</p> <p>VT 2386 L 94 P 41 H 178 four doors one drawer</p>
---	--

STANDARD ORNAMENTI SAME FINISH OF THE FURNITURE-MIRROR-CABINET **A PRICE LIST**
ON DEMAND BRUSHED ORNAMENTI ONE COLOR & BICOLOR IN 21 COLORS AND 4 METAL COLORS FOR ALL FINISHES **WITH INCREASE**

ORNAMENTI

MY

INTERNAL BOTTOM DRAWER - BIG DRAWER AND DOOR 'S COATING
STANDARD LACE AND ECO-LEATHER CORD SAME AS THE FINISHES HANDLES **OR/CO/BR**
ON DEMAND CHOOSE COLOR LACE OR ECOLEATHER AND CORD ECOLEATHER **A PRICE LIST**

LINDEN WOOD

MAKEUP CORE central

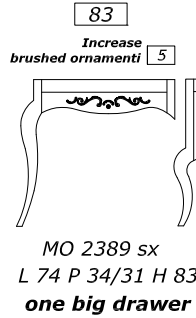
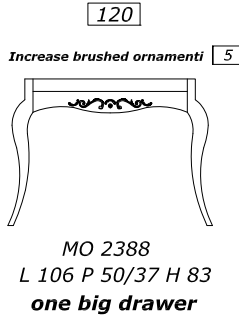

MAKEUP CORE
match it with cores or
makeup core central

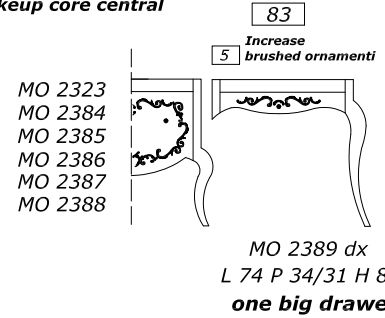

WOOD TOP

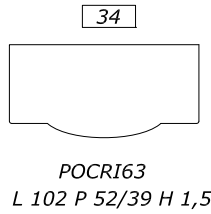
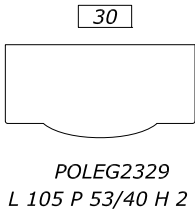

CRYSTAL TOP

INCREASE +10% WAVE MANUFACTURE -
OPTIONAL linear riser h 4 cm linear meter 10 or shaped rider h 10 cm linear meter 15 MAX LENGTH 2,25ml
14 add to matched core's POCRI

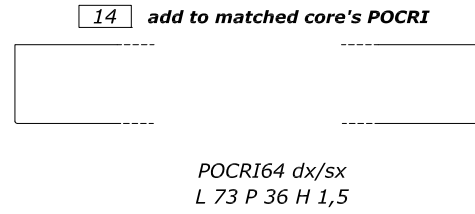

MARBLE TOP

INCREASE +25% THICKNESS CM.3 MAX LENGTH L 2,25 ml

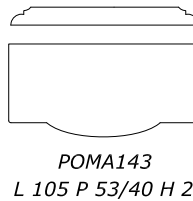

- C1 28
- C2 35
- C3 45
- C4 49
- C5 55

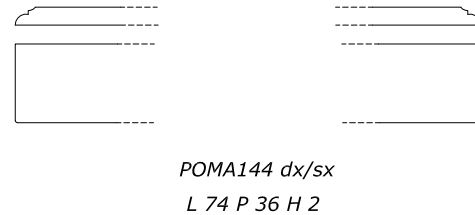

- C1 19
- C2 24
- C3 31
- C4 34
- C5 38

MIRRORS

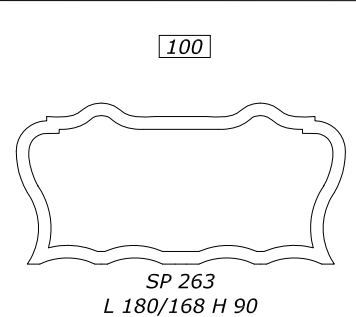
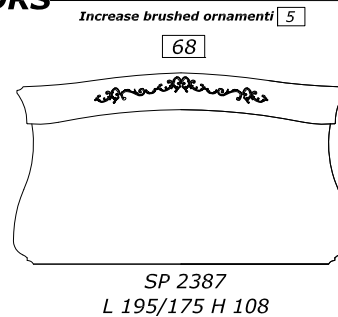
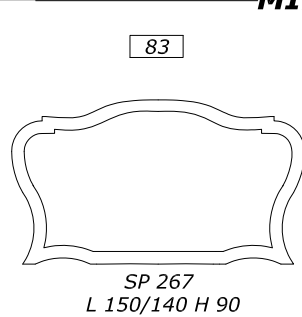
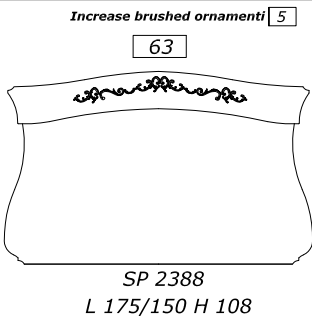

ACCESSORIES

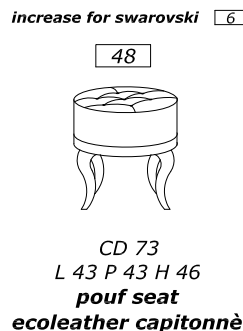
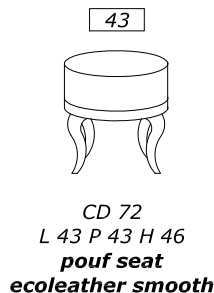
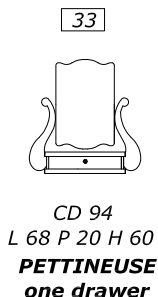

FINISH'S INCREASE
ONECOLOR-BICOLOR



ANTICATO 21 colors	PRICE LIST
PATINATO 21 colors	PRICE LIST
ANTICATO 4 metals	10%
PATINATO 4 metals	10%
LACCATO 21 colors	10%
BRILLANTE 21 colors	20%
MADREPERLA 21 colors	20%

Knob T
color and finish as furniture

IMPORTANT
COMPATIBLE WITH
WASHBASIN OF MAX SIZE
LA 63 - LA 64

PEREMPTORY 1°COLOR INTERNAL AND EXTERNAL OF DOORS, DRAWERS, BIG DRAWERS UPPER CORE AND MIRROR.
BICOLOR 2°COLOR INTERNAL AND EXTERNAL OF FURNITURE STRUCTURE - CABINET.

ON DEMAND BICOLOR WITH THE SAME FINISH
PRICE LIST WITH INCREASE FOR THE CHOICE FINISH
ON DEMAND BICOLOR WITH TWO DIFFERENT FINISHES
PRICE LIST WITH INCREASE CALCULATED ON THE HIGHER INCREASE CHOSEN FINISH

UNDERTOP WASHBASIN		OVERTOP WASHBASIN	
8 LA 63 WHITE		13 LA 64 BLACK	
internal 36,5x51,5 esternal 41x56		internal 38 esternal 40	

PEREMPTORY WITH MARBLE TOP LA 63 - LA 64
INSTALL SIPHON WITH OVERALL LESS THAN CM. 9

CORE
for one or two undertop - overtop washbasin

125
Increase brushed ornamenti 5



MO 2314
L 106 P 58/41 H 82
one big drawer

165
Increase brushed ornamenti 10

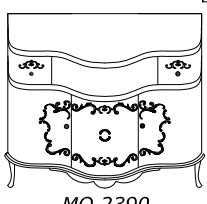

MO 2390
L 106 P 58/41 H 82
three doors
two drawers

172
Increase brushed ornamenti 8

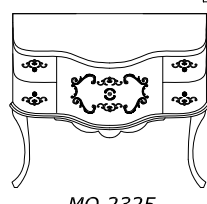

MO 2325
L 106 P 58/41 H 82
one big drawer
four drawers

195
Increase brushed ornamenti 10

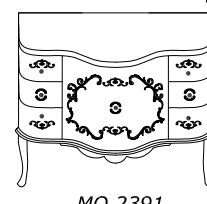

MO 2391
L 106 P 58/41 H 82
one big drawer
six drawers

345
Increase brushed ornamenti 15

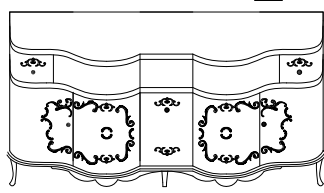

MO 2392
L 174 P 58/41 H 82
four doors
one basket
two drawers

363
Increase brushed ornamenti 15

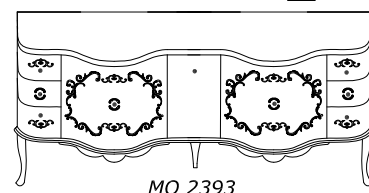

MO 2393
L 189 P 58/41 H 82
two big drawers
one basket
six drawers

CERAMIC TOP
exclusive of CORE MO 2314

54

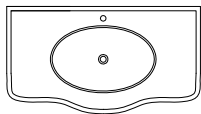

POCER59
L 110 P 61 H 4

71

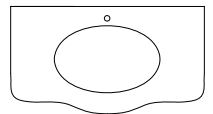

POCRI60
L 105 P 59/42 H 1,5

123

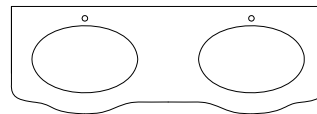

POCRI61
L 173 P 59/42 H 1,5

129

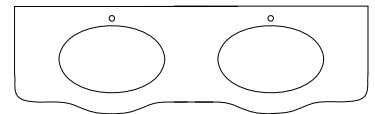

POCRI62
L 189 P 59/41 H 1,5

CRYSTAL TOP

with washbasin INCREASE +10% WAVE MANUFACTURE -
OPTIONAL linear riser h 4 cm linear meter 10 or shaped riser h 10 cm linear meter 15

MARBLE TOP

for one undertop - overtop washbasin INCREASE +25% THICKNESS CM.3

POMA109 undertop
POMA209 overtop
L 107 P 60/43 H 2

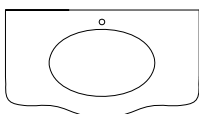

C1	33	C1	54
C2	41	C2	67
C3	51	C3	82
C4	56	C4	89
C5	62	C5	100

POMA100 undertop
POMA200 overtop
L 175 P 60/43 H 2

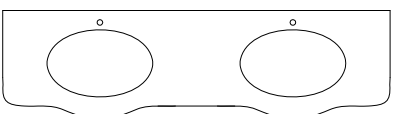

C1	58
C2	72
C3	88
C4	96
C5	108

POMA59 undertop
POMA259 overtop
L 107 P 60/43 H 2

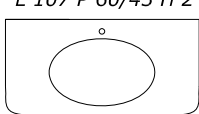

C1	33	C1	54
C2	41	C2	67
C3	51	C3	82
C4	56	C4	89
C5	62	C5	100

POMA98 undertop
POMA298 overtop
L 175 P 60/43 H 2

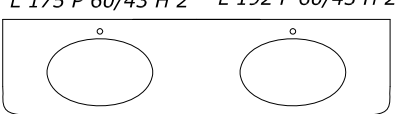

C1	58
C2	72
C3	88
C4	96
C5	108

POMA88 undertop
POMA288 overtop
L 192 P 60/43 H 2

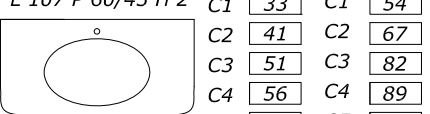

C1	58
C2	72
C3	88
C4	96
C5	108

MIRRORS

Increase brushed ornamenti 5

41

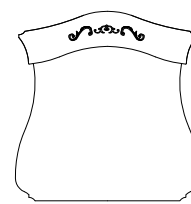

SP 2390
L 105/82 H 108

50

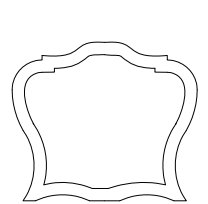

SP 250
L 93/82 H 90

ACCESSORIES

Increase brushed ornamenti 10

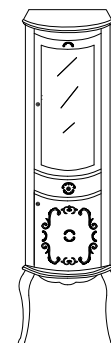

161
VT 2390 Sx-Dx
L 53 P 41 H 178
two doors
one drawer

STANDARD ORNAMENTI SAME FINISH OF THE FURNITURE-MIRROR-CABINET **A PRICE LIST**
ON DEMAND BRUSHED ORNAMENTI ONE COLOR & BICOLOR IN 21 COLORS AND 4 METAL COLORS FOR ALL FINISHES **WITH INCREASE**

ORNAMENTI

MY

INTERNAL BOTTOM DRAWER - BIG DRAWER AND DOOR 'S COATING
STANDARD LACE AND ECO-LEATHER CORD SAME AS THE FINISHES HANDLES **OR/CO/BR**
ON DEMAND CHOOSE COLOR LACE OR ECOLEATHER AND CORD ECOLEATHER **A PRICE LIST**

LINDEN WOOD

MAKEUP CORE central

MAKEUP CORE
*match it with cores or
 makeup core central*

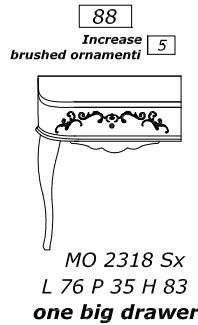
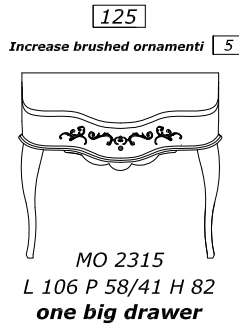

MO 2314
 MO 2390
 MO 2325
 MO 2391
 MO 2392
 MO 2393
 MO 2315

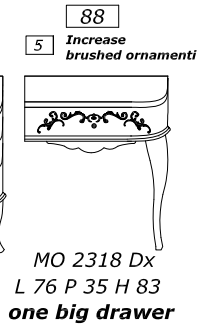

WOOD TOP

CRYSTAL TOP

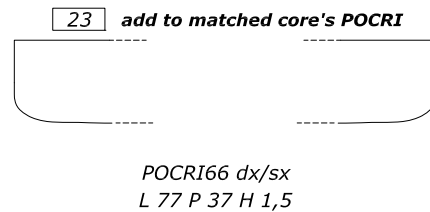
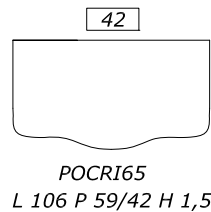
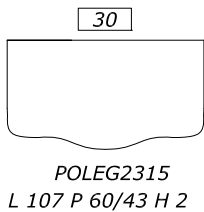

INCREASE +10% WAVE MANUFACTURE -
 OPTIONAL linear riser h 4 cm linear meter 10 or shaped rider h 10 cm linear meter 15 MAX LENGTH 2,25ml

MARBLE TOP

INCREASE +25% THICKNESS CM.3 MAX LENGTH L 2,25 ml

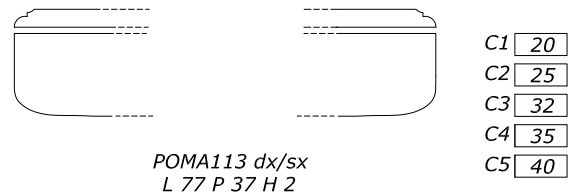
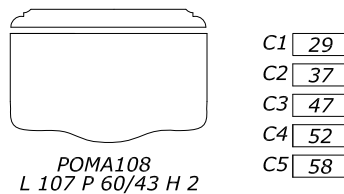

MIRRORS

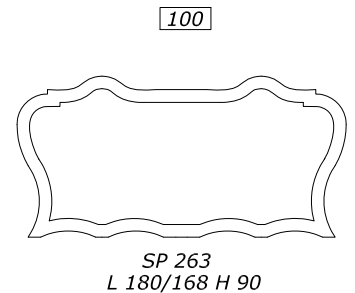
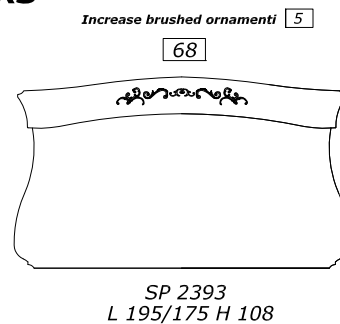
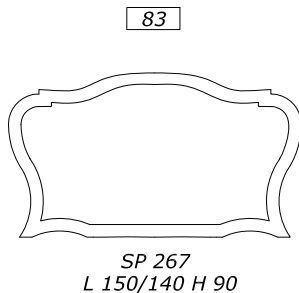
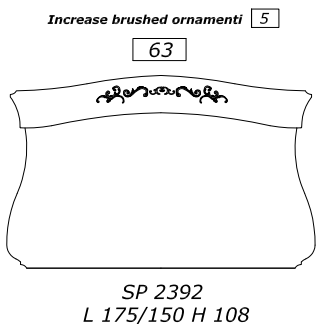

ACCESSORIES

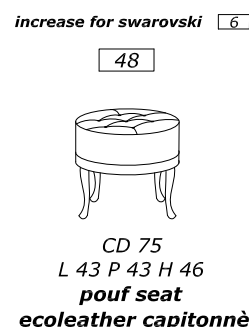
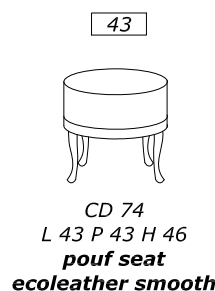
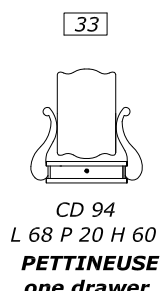
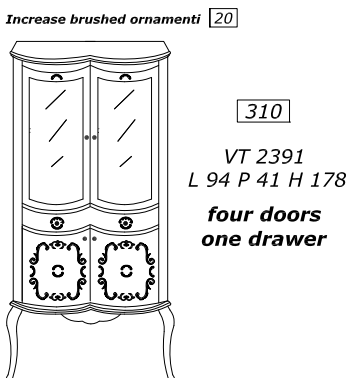

**FINISH'S INCREASE
 ONECOLOR-BICOLOR**

ANTICATO 21 colors	PRICE LIST
PATINATO 21 colors	PRICE LIST
ANTICATO 4 metals	10%
PATINATO 4 metals	10%
LACCATO 21 colors	10%
BRILLANTE 21 colors	20%
MADREPERLA 21 colors	20%

RILIEVI

Knob Q

PEREMPTORY 1°COLOR INTERNAL AND EXTERNAL OF DOORS , DRAWERS , BIG DRAWERS AND MIRROR
BICOLORE 2°COLOR INTERNAL AND EXTERNAL OF FURNITURE STRUCTURE , CABINET

ON DEMAND BICOLOR WITH THE SAME FINISH
 PRICE LIST WITH INCREASE FOR THE CHOICE FINISH
ON DEMAND BICOLOR WITH TWO DIFFERENT FINISHES
 PRICE LIST WITH INCREASE CALCULATED ON THE HIGHER INCREASE CHOOSEN FINISH

UNDERTOP WASHBASIN		OVERTOP WASHBASIN	
8 LA 63 WHITE		13 LA 64 BLACK	27 FOGLIA Similgold LA 50
internal 36,5x51,5 esternal 41x56		internal 38 esternal 40	

PEREMPTORY WITH MARBLE TOP LA 63 - LA 64
 INSTALL SIPHON WITH OVERALL LESS THAN CM. 9

CORE

for one or two undertop-overtop washbasin

<p>139 increase outline relief metal finish 5</p> <p>MO 2353 L 130/110 P 64 H 83 one big drawer</p>	<p>217 increase outline relief metal finish 10</p> <p>MO 2350 L 132/119 P 56 H 83 one big drawer</p>	<p>287 increase outline relief metal finish 10</p> <p>MO 2351 L 132/119 P 56 H 83 one big drawer four drawers</p>	<p>261 increase outline relief metal finish 10</p> <p>MO 2352 L 132/119 P 56 H 83 two big drawers</p>	<p>380 increase outline relief metal finish 10</p> <p>MO 2354 one washbasin L 185/172 P 63 H 83 one big drawer four drawers</p>	<p>352 increase outline relief metal finish 10</p> <p>MO 2355 two washbasins L 185/172 P 63 H 83 one big drawer two drawers</p>
--	---	--	--	---	---

CRYSTAL TOP

with washbasin INCREASE +10% WAVE MANUFACTURE - OPTIONAL linear riser h 4 cm linear meter 10 or shaped riser h 10 cm linear meter 15

<p>80</p> <p>POCRI93 L 133/113 P 66 H 1,5</p>	<p>76</p> <p>POCRI90 L 121/89 P 57 H 1,5</p>	<p>97</p> <p>POCRI91 L 174/146 P 65 H 1,5</p>	<p>123</p> <p>POCRI92 L 174/146 P 65 H 1,5</p>
---	--	---	--

MARBLE TOP

for one or two undertop - overtop washbasin INCREASE +25% THICKNESS CM.3

<p>POMA175 undertop POMA275 overtop L 135/115 P 67 H 2</p> <p>C1 39 C2 48 C3 59 C4 65 C5 73</p>	<p>POMA160 undertop POMA260 overtop L 123/91 P 58 H 2</p> <p>C1 35 C2 44 C3 54 C4 59 C5 66</p>	<p>POMA161 for 1 undertop POMA261 for 1 overtop POMA162 for 2 undertop POMA262 for 2 overtop L 177/148 P 65 H 2</p>	<p>POMA184 for 1 undertop POMA284 for 1 overtop POMA186 for 2 undertop POMA286 for 2 overtop L 177/148 P 65 H 2</p> <p>C1 52 C2 64 C3 79 C4 87 C5 97</p>
---	--	---	--

MIRRORS

<p>increase outline relief metal finish 5</p> <p>49</p> <p>SP 2350 L 115/92 H 108</p>	<p>50</p> <p>SP 250 L 93/83 H 90</p>	<p>increase outline relief metal finish 5</p> <p>61</p> <p>SP 2355 L 175/150 H 108</p>	<p>83</p> <p>SP 267 L 150/140 H 90</p>
---	--	--	--

ACCESSORIES

<p>5 increase outline relief metal finish</p> <p>213 VT 2350 Sx-Dx L 70/62 P 38 H 180 one door one drawer one big drawer</p>	<p>10 increase outline relief metal finish</p> <p>388 VT 2352 L 132/119 P 38 H 180 two doors two big drawers</p>	<p>increase outline relief metal finish 10</p> <p>263 VT 2353 L 132/119 P 38 H 85 two big drawers</p> <p>increase outline relief metal finish 5</p> <p>130 VT 2351 L 70/53 P 38 H 85 one big drawer</p>
---	---	---

STANDARD RELIEF OUTLINE SAME COLOR AND FINISH OF THE FURNITURE -MIRROR-CABINET **A PRICE LIST**
ON DEMAND RELIEF OUTLINE 4 METALLI ONLY FOR FINISHES NF-ND-RM-AT-PT-LC 21 COLORS **WITH INCREASE**

RILIEVI

MY

INTERNAL BOTTOM DRAWER - BIG DRAWER AND DOOR 'S COATING
STANDARD LACE AND ECO-LEATHER CORD SAME AS HANDLES **OR/CO/BR**
ON DEMAND CHOOSE COLOR LACE OR ECOLEATHER AND CORD ECOLEATHER **A PRICE LIST**

LINDEN WOOD

MAKEUP CORE central

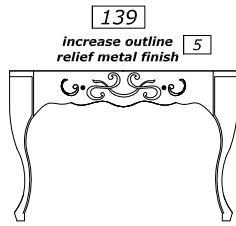

MO 2363
L 130/110 P 64 H 83
one big drawer

MAKEUP CORE
match it with cores or
makeup core central

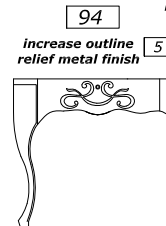

MO 2356 sx
L 85 P 48 H 83
one big drawer

- MO 2350
- MO 2351
- MO 2352
- MO 2353
- MO 2354
- MO 2355
- MO 2363

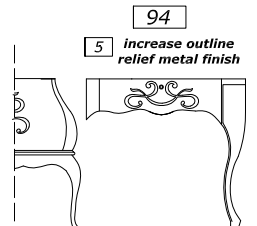

MO 2356 dx
L 85 P 48 H 83
one big drawer

WOOD TOP

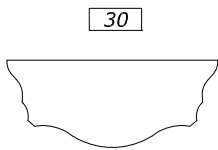

POLEG2312
L 135/115 P 67 H 2

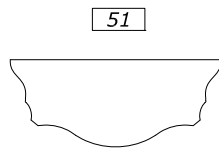

POCRI24
L 133/113 P 66 H 1,5

CRYSTAL TOP

INCREASE +10% WAVE MANUFACTURE -
OPTIONAL linear riser h 4 cm linear meter **10** or shaped rider h 10 cm linear meter **15** **MAX LENGTH 2,25ml**

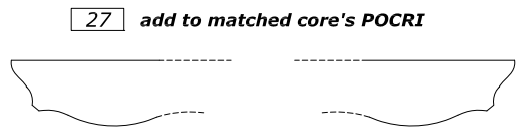

POCRI28 dx/sx
L 86 P 49 H 1,5

MARBLE TOP

INCREASE +25% THICKNESS CM.3 MAX LENGTH L 2,25 ml

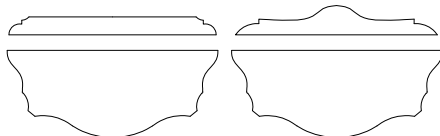

POMA105
L 135/115 P 67 H 2

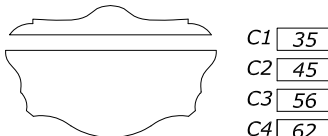

POMA106
L 135/115 P 67 H 2

- C1 **35**
- C2 **45**
- C3 **56**
- C4 **62**
- C5 **69**



POMA107 dx/sx
L 87 P 51 H 2

- C1 **23**
- C2 **29**
- C3 **36**
- C4 **40**
- C5 **45**

MIRRORS

increase outline relief metal finish **5**

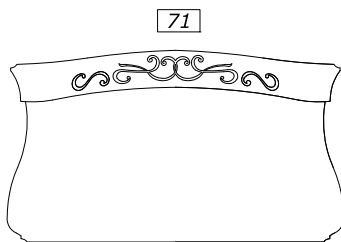

SP 2356
L 195/170 H 108

100

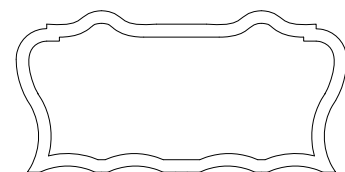

SP 263
L 180/168 H 90

ACCESSORIES

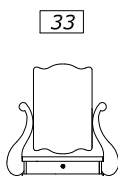

CD 94
L 68 P 20 H 60
PETTINEUSE
one drawer

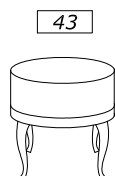

CD 70
L 43 P 43 H 46
pouf seat
ecoleather smooth

increase for swarovski **6**

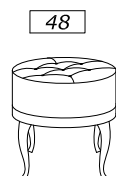

CD 71
L 43 P 43 H 46
pouf seat
ecoleather capitonné

FINISH'S INCREASE
ONECOLOR-BICOLOR

NERO F.-ROSSO M.-NOCE D.	PRICE LIST
ANTICATO 21 colors	PRICE LIST
PATINATO 21 colors	PRICE LIST
ANTICATO 4 metals	10%
PATINATO 4 metals	10%
LACCATO 21 colors	10%
BRILLANTE 21 colors	20%
MADREPERLA 21 colors	20%
FOGLIA oro/argento	10%
FOGLIA PATINATA oro/arg	10%

Knob Q

PEREMPTORY 1°COLOR INTERNAL AND EXTERNAL OF DOORS , DRAWERS , BIG DRAWERS UPPER CORE AND MIRROR.
BICOLOR 2°COLOR INTERNAL AND EXTERNAL OF FURNITURE STRUCTURE - CABINET.
ON DEMAND BICOLOR WITH THE SAME FINISH
 PRICE LIST WITH INCREASE FOR THE CHOICE FINISH
ON DEMAND BICOLOR WITH TWO DIFFERENT FINISHES
 PRICE LIST WITH INCREASE CALCULATED ON THE HIGHER INCREASE CHOOSEN FINISH

UNDERTOP WASHBASIN		OVERTOP WASHBASIN	
8 LA 63 WHITE		13 LA 64 BLACK	
internal 36,5x51,5 esternal 41x56		internal 38 esternal 40	

IMPORTANT
 COMPATIBLE WITH
 WASHBASIN OF MAX SIZE
 LA 63 - LA 64

PEREMPTORY WITH MARBLE TOP LA 63 - LA 64
 INSTALL SIPHON WITH OVERALL LESS THAN CM. 9

CORE
 for one or two undertop - overtop washbasin

<p>139</p> <p>increase outline 5 relief metal finish</p> <p>MO 2353 L 130/110 P 64 H 83 one big drawer</p>	<p>235</p> <p>increase outline 10 relief metal finish</p> <p>MO 2360 L 132/110 P 60 H 82 two doors two drawers</p>	<p>279</p> <p>increase outline 10 relief metal finish</p> <p>MO 2361 L 132/110 P 60 H 82 two big drawers two drawers</p>	<p>321</p> <p>increase outline 10 relief metal finish</p> <p>MO 2362 L 176/152 P 60 H 82 two doors three drawers</p>
---	---	---	---

CRYSTAL TOP

with washbasin **INCREASE +10% WAVE MANUFACTURE** - OPTIONAL linear riser h 4 cm linear meter 10 or shaped riser h 10 cm linear meter 15

<p>80</p> <p>POCRI93 L 133/115 P 66 H 1,5</p>	<p>76</p> <p>POCRI40 L 123/104 P 59 H 1,5</p>	<p>92</p> <p>POCRI41 L 166/148 P 59 H 1,5</p>	<p>123</p> <p>POCRI42 L 166/148 P 59 H 1,5</p>
---	---	---	--

MARBLE TOP

for one or two undertop - overtop washbasin **INCREASE +25% THICKNESS CM.3**

<p>POMA175 undertop POMA275 overtop L 135/115 P 67 H 2</p> <p>C1 39 C2 48 C3 59 C4 65 C5 73</p>	<p>POMA194 undertop POMA294 overtop L 124/105 P 59 H 2</p> <p>C1 36 C2 45 C3 56 C4 61 C5 68</p>	<p>POMA195 for 1 undertop POMA295 for 1 overtop POMA196 for 2 undertops POMA296 for 2 overtops L 167/149 P 59 H 2</p>	<p>POMA12 for 1 undertop POMA212 for 1 overtop POMA63 for 2 undertops POMA263 for 2 overtops L 167/149 P 59 H 2</p> <p>C1 50 C2 62 C3 76 C4 83 C5 93</p>
---	---	---	--

MIRRORS

<p>increase outline relief metal finish 5</p> <p>49</p> <p>SP 2360 L 115/92 H 108</p>	<p>50</p> <p>SP 250 L 93/83 H 90</p>	<p>increase outline relief metal finish 5</p> <p>61</p> <p>SP 2362 L 175/150 H 108</p>	<p>83</p> <p>SP 267 L 150/140 H 90</p>
---	--	--	--

ACCESSORIES

<p>5 increase outline relief metal finish</p> <p>213 VT 2360 Sx-Dx L 71/53 P 38 H 180 two doors two drawers</p>	<p>10 increase outline relief metal finish</p> <p>406 VT 2362 L 132/110 P 38 H 180 two doors two drawers two big drawers</p>	<p>increase outline relief metal finish 10</p> <p>281 VT 2363 L 132/119 P 38 H 85 two big drawers two drawers</p>	<p>increase outline relief metal finish 5</p> <p>130 VT 2361 Sx-Dx L 71/53 P 38 H 85 one door one drawer</p>
--	---	--	---

STANDARD RELIEF OUTLINE SAME COLOR AND FINISH OF THE FURNITURE -MIRROR-CABINET **A PRICE LIST**
ON DEMAND RELIEF OUTLINE 4 METALLI ONLY FOR FINISHES NF-ND-RM-AT-PT-LC 21 COLORS **WITH INCREASE**

ORNAMENTI

MY

INTERNAL BOTTOM DRAWER - BIG DRAWER AND DOOR 'S COATING
STANDARD LACE AND ECO-LEATHER CORD SAME AS HANDLES **OR/CO/BR**
ON DEMAND CHOOSE COLOR LACE OR ECOLEATHER AND CORD ECOLEATHER **A PRICE LIST**

LINDEN WOOD

MAKEUP CORE central

MAKEUP CORE
 match it with cores or
 makeup core central

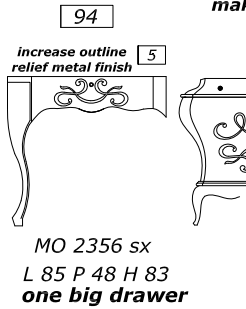
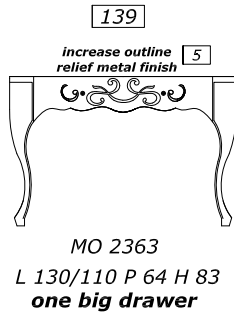

MO 2353
 MO 2360
 MO 2361
 MO 2362
 MO 2363

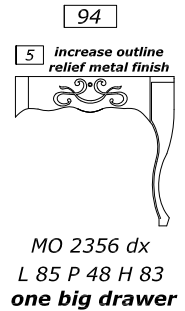

WOOD TOP

CRYSTAL TOP

INCREASE +10% WAVE MANUFACTURE -
 OPTIONAL linear riser h 4 cm linear meter 10 or shaped rider h 10 cm linear meter 15 MAX LENGTH 2,25ml

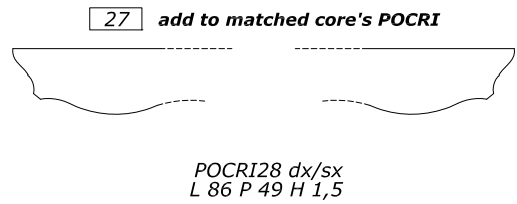
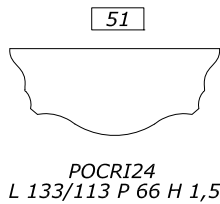
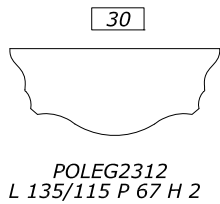

MARBLE TOP

INCREASE +25% THICKNESS CM.3 MAX LENGTH L 2,25 ml

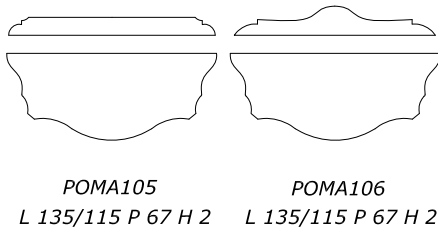

C1 35
 C2 45
 C3 56
 C4 62
 C5 69

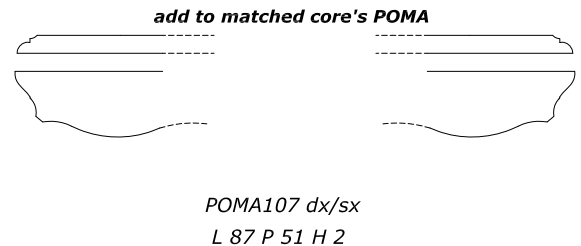

C1 23
 C2 29
 C3 36
 C4 40
 C5 45

MIRRORS

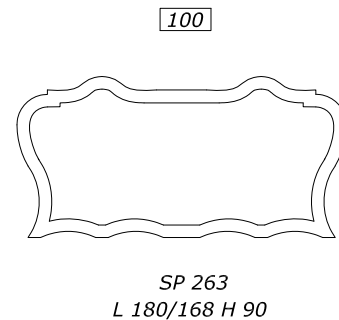
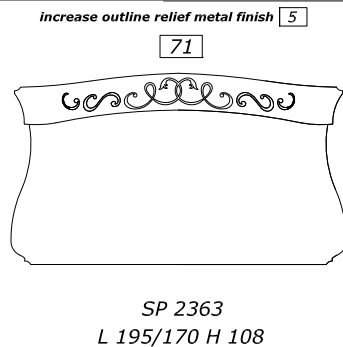

ACCESSORIES

FINISH'S INCREASE
ONECOLOR-BICOLOR

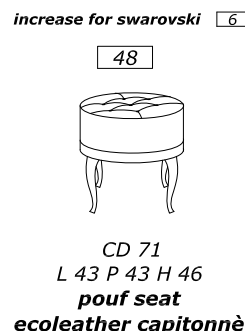
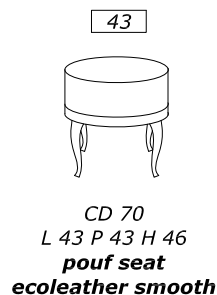
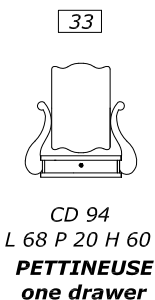

NERO F.-ROSSO M.-NOCE D.	PRICE LIST
ANTICATO 21 colors	PRICE LIST
PATINATO 21 colors	PRICE LIST
ANTICATO 4 metals	10%
PATINATO 4 metals	10%
LACCATO 21 colors	10%
BRILLANTE 21 colors	20%
MADREPERLA 21 colors	20%
FOGLIA oro/argento	10%
FOGLIA PATINATA oro/arg	10%

Knob Q

IMPORTANT
COMPATIBLE WITH
WASHBASIN OF MAX SIZE
LA 63 - LA 64

PEREMPORY 1°COLOR INTERNAL AND EXTERNAL OF DOORS , DRAWERS , BIG DRAWERS AND MIRROR
BICOLORE 2°COLOR INTERNAL AND EXTERNAL OF FURNITURE STRUCTURE , CABINET

ON DEMAND BICOLOR WITH THE SAME FINISH
PRICE LIST WITH INCREASE FOR THE CHOICE FINISH
ON DEMAND BICOLOR WITH TWO DIFFERENT FINISHES
PRICE LIST WITH INCREASE CALCULATED ON THE HIGHER INCREASE CHOSEN FINISH

UNDERTOP WASHBASIN		OVERTOP WASHBASIN	
8 LA 63 WHITE		13 LA 64 BLACK	
internal 36,5x51,5 external 41x56		internal 38 external 40	

PEREMPORY WITH MARBLE TOP LA 63 - LA 64
INSTALL SIPHON WITH OVERALL LESS THAN CM. 9

CORE

for one undertop - overtop washbasin

177

increase outline relief metal finish 10

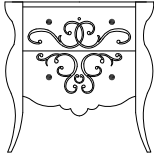

MO 2370
L 90/72 P 58 H 83
two big drawers

132

increase outline relief metal finish 5

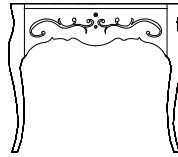

MO 2369
L 115/95 P 58 H 83
one big drawer

188

increase outline relief metal finish 10

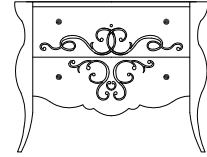

MO 2371
L 115/95 P 58 H 83
two big drawers

CRYSTAL TOP

with washbasin INCREASE +10% WAVE MANUFACTURE - OPTIONAL linear riser h 4 cm linear meter 10 or shaped riser h 10 cm linear meter 15

57

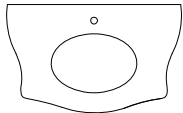

POCRI15
L 89/75 P 58 H 1,5

74

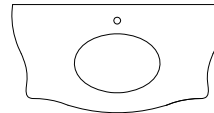

POCRI43
L 113/99 P 58 H 1,5

MARBLE TOP

for one undertop - overtop washbasin INCREASE +25% THICKNESS CM.3

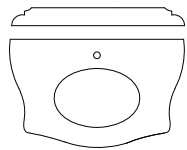

POMA118 undertop
POMA218 overtop
L 91/77 P 59 H 2

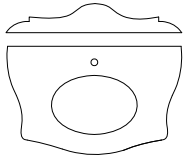

POMA119 undertop
POMA219 overtop
L 91/77 P 59 H 2

- C1 27
- C2 33
- C3 41
- C4 45
- C5 50

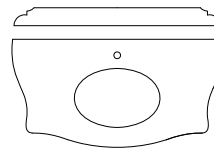

POMA139 undertop
POMA239 overtop
L 116/100 P 59 H 2

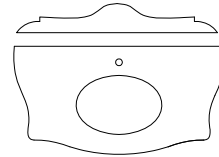

POMA24 undertop
POMA224 overtop
L 116/100 P 59 H 2

- C1 35
- C2 44
- C3 53
- C4 59
- C5 66

MIRRORS

increase outline relief metal finish 5

45



SP 2370
L 85/62 H 108

46

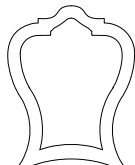

SP 252
L 71/60 H 90

49

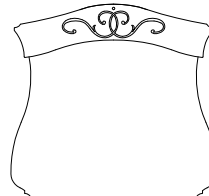

SP 2371
L 115/92 H 108

50

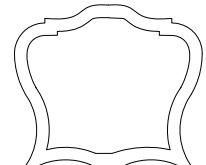

SP 250
L 93/83 H 90

ACCESSORIES

10

increase outline relief metal finish

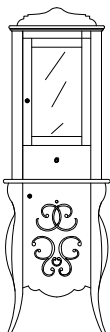

197
VT 2370 Sx-Dx
L 65/53 P 38 H 180
two doors
one drawer

10

increase outline relief metal finish



317
VT 2372
L 106/100 P 41 H 180
two doors
two big drawers

increase outline relief metal finish 10

192

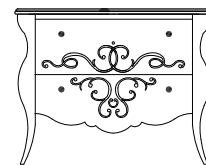

VT 2373
L 106/100 P 41 H 85
two big drawers

increase outline relief metal finish 10

114

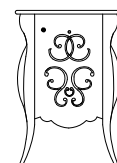

VT 2371 Sx-Dx
L 65/53 P 38 H 85
one door

STANDARD RELIEF OUTLINE SAME COLOR AND FINISH OF THE FURNITURE -MIRROR-CABINET **A PRICE LIST**
ON DEMAND RELIEF OUTLINE 4 METALLI ONLY FOR FINISHES NF-ND-RM-AT-PT-LC 21 COLORS **WITH INCREASE**

RILIEVI

MY

INTERNAL BOTTOM DRAWER - BIG DRAWER AND DOOR 'S COATING

STANDARD LACE AND ECO-LEATHER CORD SAME AS HANDLES **OR/CO/BR**
ON DEMAND CHOOSE COLOR LACE OR ECOLEATHER AND CORD ECOLEATHER **A PRICE LIST**

LINDEN WOOD

MAKEUP CORE central

MAKEUP CORE

match it with cores or
makeup core central

132
increase outline relief metal finish 5

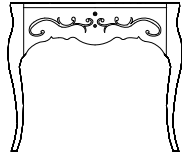

MO 2374
L 115/95 P 58 H 83
one big drawer

97
increase outline relief metal finish 5

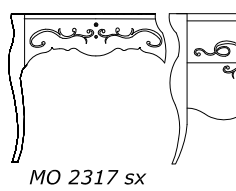

MO 2317 sx
L 87 P 48 H 83
one big drawer

MO 2370
MO 2369
MO 2371
MO 2374

97
increase outline relief metal finish 5

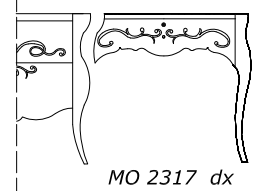

MO 2317 dx
L 82 P 50 H 83
one big drawer

WOOD TOP

CRYSTAL TOP

INCREASE +10% WAVE MANUFACTURE -
OPTIONAL linear riser h 4 cm linear meter 10 or shaped rider h 10 cm linear meter 15 MAX LENGTH 2,25ml

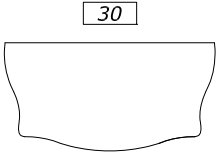

POLEG2399
L 116/100 P 59 H 2

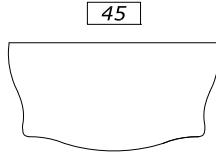

POCRI73
L 113/99 P 58 H 1,5

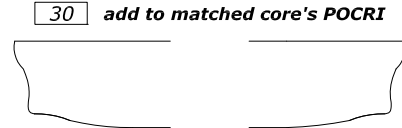

POCRI74 dx/sx
L 88 P 49 H 1,5

MARBLE TOP

INCREASE +25% THICKNESS CM.3 MAX LENGTH L 2,25 ml
add to matched core's POMA

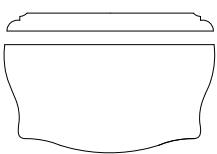

POMA102
L 116/100 P 59 H 2

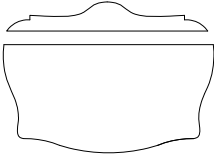

POMA103
L 116/100 P 59 H 2

- C1 31
- C2 40
- C3 49
- C4 55
- C5 62

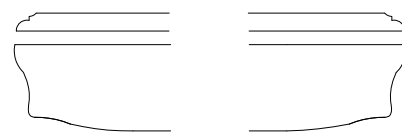

POMA104 dx/sx
L 89 P 49 H 2

- C1 23
- C2 29
- C3 37
- C4 40
- C5 46

MIRRORS

increase outline relief metal finish 5

increase outline relief metal finish 5

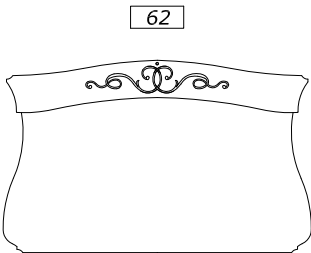

SP 2372
L 175/150 H 108

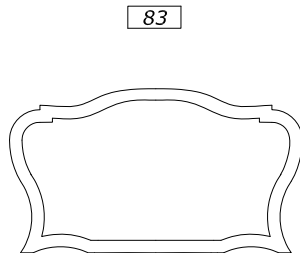

SP 267
L 150/140 H 90

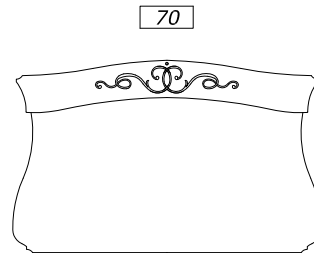

SP 2373
L 195/170 H 108

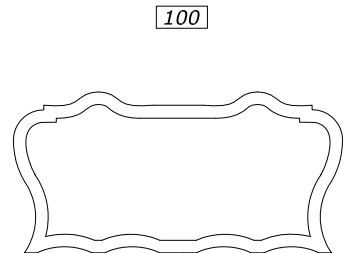

SP 263
L 180/168 H 90

ACCESSORIES

FINISH'S INCREASE
ONECOLOR-BICOLOR

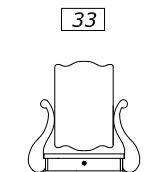

CD 94
L 68 P 20 H 60
PETTINEUSE
one drawer

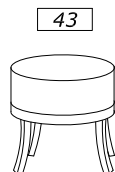

CD 95
L 43 P 43 H 46
pouf seat
ecoleather smooth

increase for swarovski 6



CD 96
L 43 P 43 H 46
pouf seat
ecoleather capitonné

NERO F.-ROSSO M.-NOCE D.	PRICE LIST
ANTICATO 21 colors	PRICE LIST
PATINATO 21 colors	PRICE LIST
ANTICATO 4 metals	10%
PATINATO 4 metals	10%
LACCATO 21 colors	10%
BRILLANTE 21 colors	15%
MADREPERLA 21 colors	15%
FOGLIA oro/argento	15%
FOGLIA PATINATA oro/arg	15%

Knob Q

IMPORTANT
COMPATIBLE WITH
WASHBASIN OF MAX SIZE
LA 63 - LA 64

PEREMPTORY 1°COLOR INTERNAL AND EXTERNAL OF DOORS , DRAWERS , BIG DRAWERS AND MIRROR
BICOLORE 2°COLOR INTERNAL AND EXTERNAL OF FURNITURE STRUCTURE , CABINET

ON DEMAND BICOLOR WITH THE SAME FINISH

PRICE LIST WITH INCREASE FOR THE CHOICE FINISH

ON DEMAND BICOLOR WITH TWO DIFFERENT FINISHES

PRICE LIST WITH INCREASE CALCULATED ON THE HIGHER INCREASE CHOSEN FINISH

UNDERTOP WASHBASIN		OVERTOP WASHBASIN	
8 LA 63 WHITE		13 LA 64 BLACK	
internal 36,5x51,5 esternal 41x56		internal 38 esternal 40	

PEREMPTORY WITH MARBLE TOP LA 63 - LA 64
INSTALL SIPHON WITH OVERALL LESS THAN CM. 9

CORE

for one or two undertop - overtop washbasin

248

increase outline relief metal finish 15

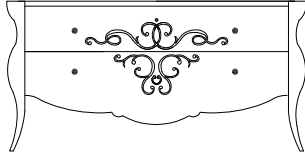

MO 2372
L 173/153 P 58 H 83
two big drawers

304

increase outline relief metal finish 20

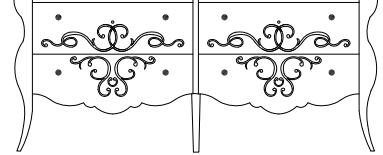

MO 2373
L 203/182 P 58 H 83
four big drawers

CRYSTAL TOP

with washbasin INCREASE +10% WAVE MANUFACTURE - OPTIONAL linear riser h 4 cm linear meter 10 or shaped riser h 10 cm linear meter 15

92

123

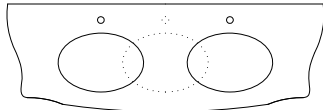

POCRI44 for 1 washbasin
L 172/156 P 58 H 1,5

POCRI45 for 2 washbasins
L 172/156 P 58 H 1,5

137

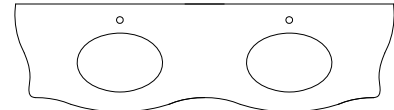

POCRI46
L 200/185 P 58 H 1,5

MARBLE TOP

for one or two undertop - overtop washbasin INCREASE +25% THICKNESS CM.3

POMA116 one undertop

POMA115 two undertops

POMA216 one overtop

POMA215 two overtops

L 173/157 P 59 H 2

C1 51

C2 63

C3 79

C4 86

C5 97

POMA117 undertop

POMA217 overtop

L 202/186 P 59 H 2

C1 62

C2 76

C3 94

C4 103

C5 115

POMA04 one undertop

POMA02 two undertops

POMA204 one overtop

POMA202 two overtops

L 173/157 P 59 H 2

POMA43 undertop

POMA243 overtop

L 202/186 P 59 H 2

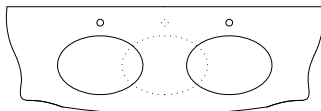

MIRRORS

increase outline relief metal finish 5

62

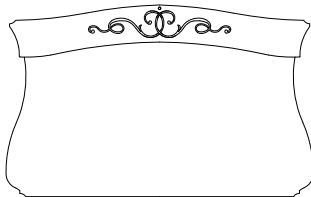

SP 2372
L 175/150 H 108

83

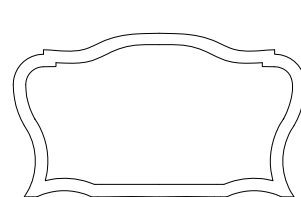

SP 267
L 150/140 H 90

ACCESSORIES

10

increase outline relief metal finish

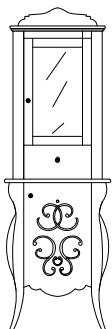

197

VT 2370 Sx-Dx
L 65/53 P 38 H 180
two doors
one drawer

10

increase outline relief metal finish



317

VT 2372
L 106/100 P 41 H 180
two doors
two big drawers

increase outline relief metal finish 10

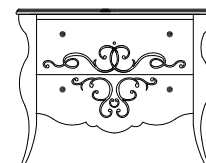

192

VT 2373
L 106/100 P 41 H 85
two big drawers

increase outline relief metal finish 10

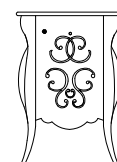

114

VT 2371 Sx-Dx
L 65/53 P 38 H 85
one door

STANDARD RELIEF OUTLINE SAME COLOR AND FINISH OF THE FURNITURE -MIRROR-CABINET **A PRICE LIST**
ON DEMAND RELIEF OUTLINE 4 METALLI ONLY FOR FINISHES NF-ND-RM-AT-PT-LC 21 COLORS **WITH INCREASE**

RILIEVI

MY

INTERNAL BOTTOM DRAWER - BIG DRAWER AND DOOR 'S COATING
STANDARD LACE AND ECO-LEATHER CORD SAME AS HANDLES **OR/CO/BR**
ON DEMAND CHOOSE COLOR LACE OR ECOLEATHER AND CORD ECOLEATHER **A PRICE LIST**

LINDEN WOOD

MAKEUP CORE central

MAKEUP CORE

match it with cores or
makeup core central

132

increase outline relief metal finish 5

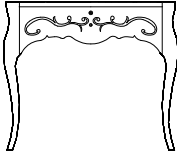

MO 2374
L 115/95 P 58 H 83
one big drawer

97

increase outline relief metal finish 5

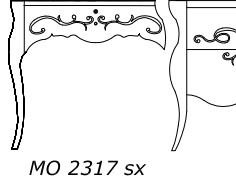

MO 2317 sx
L 87 P 48 H 83
one big drawer

97

5 increase outline relief metal finish

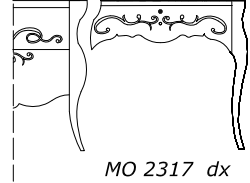

MO 2317 dx
L 87 P 48 H 83
one big drawer

MO 2372
MO 2373
MO 2374

WOOD TOP

CRYSTAL TOP

INCREASE +10% WAVE MANUFACTURE -
OPTIONAL linear riser h 4 cm linear meter 10 or shaped rider h 10 cm linear meter 15 MAX LENGTH 2,25ml

30

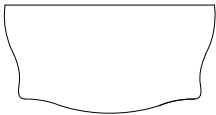

POLEG2399
L 116/100 P 59 H 2

45

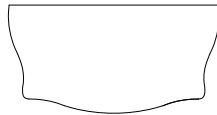

POCRI73
L 113/99 P 58 H 1,5

30

add to matched core's POCRI



POCRI74 dx/sx
L 88 P 48 H 1,5

MARBLE TOP

INCREASE +25% THICKNESS CM.3 MAX LENGTH L 2,25 ml

add to matched core's POMA

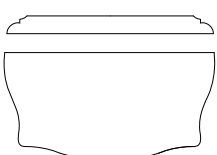

POMA102
L 116/100 P 59 H 2

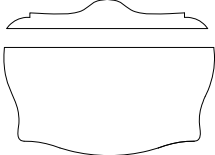

POMA103
L 116/100 P 59 H 2

- C1 31
- C2 40
- C3 49
- C4 55
- C5 62

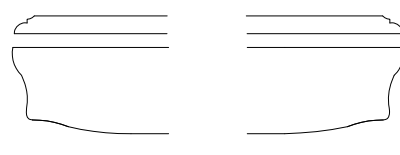

POMA104 dx/sx
L 89 P 49 H 2

- C1 23
- C2 29
- C3 37
- C4 40
- C5 46

MIRRORS

increase outline relief metal finish 5

70

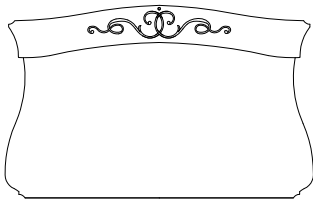

SP 2373
L 195/170 H 108

100

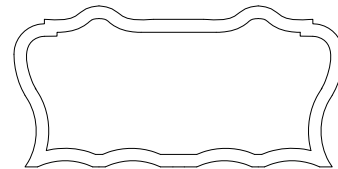

SP 263
L 180/168 H 90

ACCESSORIES

33

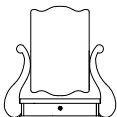

CD 94
L 68 P 20 H 60
PETTINEUSE
one drawer

43



CD 95
L 43 P 43 H 46
pouf seat
ecoleather smooth

increase for swarovski 6

48



CD 96
L 43 P 43 H 46
pouf seat
ecoleather capitonné

FINISH'S INCREASE
ONECOLOR-BICOLOR

NERO F.-ROSSO M.-NOCE D.	PRICE LIST
ANTICATO 21 colors	PRICE LIST
PATINATO 21 colors	PRICE LIST
ANTICATO 4 metals	10%
PATINATO 4 metals	10%
LACCATO 21 colors	10%
BRILLANTE 21 colors	15%
MADREPERLA 21 colors	15%
FOGLIA oro/argento	15%
FOGLIA PATINATA oro/arg	15%

Knob Q

IMPORTANT
COMPATIBLE WITH
WASHBASIN OF MAX SIZE
LA 63 - LA 64 - LA 03

PEREMPTORY 1°COLOR INTERNAL AND EXTERNAL OF DOORS, DRAWERS, BIG DRAWERS AND MIRROR.
BICOLOR 2°COLOR INTERNAL AND EXTERNAL OF FURNITURE STRUCTURE - CABINET.

ON DEMAND BICOLOR WITH THE SAME FINISH
PRICE LIST WITH INCREASE FOR THE CHOICE FINISH
ON DEMAND BICOLOR WITH TWO DIFFERENT FINISHES
PRICE LIST WITH INCREASE CALCULATED ON THE HIGHER INCREASE CHOOSEN FINISH

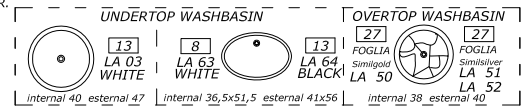

PEREMPTORY WITH MARBLE TOP LA 63 - LA 64
INSTALL SIPHON WITH OVERALL LESS THAN CM. 9

CORE

for one or two undertop - overtop washbasin

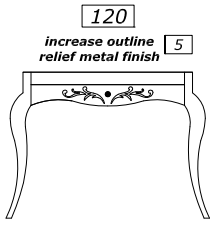

120
increase outline relief metal finish 5
MO 2320
L 106 P 50/37 H 83
one big drawer

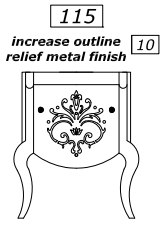

115
increase outline relief metal finish 10
MO 2349
L 63 P 52/37 H 83
one big drawer

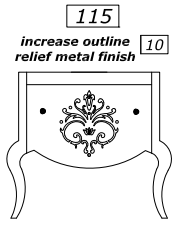

115
increase outline relief metal finish 10
MO 2357
L 84 P 50/37 H 83
one big drawer

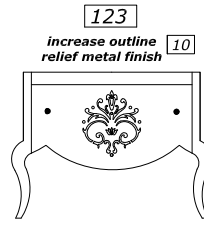

123
increase outline relief metal finish 10
MO 2358
L 104 P 50/37 H 83
one big drawer

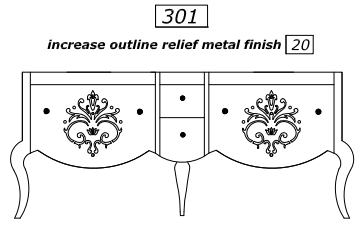

301
increase outline relief metal finish 20
MO 2359
L 190 P 50/37 H 83
two big drawers
two drawers

CERAMIC TOP

except of CORE MO 2320

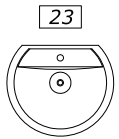

23
POCER11
L 59 P 52 H 4

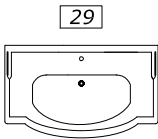

29
POCER10
L 89 P 55 H 4

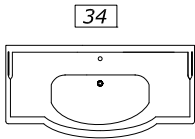

34
POCER12
L 109 P 55 H 4

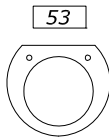

53
POCRI10
L 62 P 52 H 1,5
only one tap hole Sx - Dx

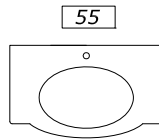

55
POCRI49
L 82 P 52/39 H 1,5

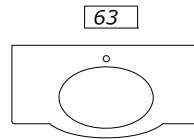

63
POCRI50
L 102 P 52/39 H 1,5

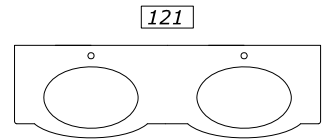

121
POCRI51
L 187 P 52/39 H 1,5

CRYSTAL TOP

with washbasin INCREASE +10% WAVE MANUFACTURE -
OPTIONAL linear riser h 4 cm linear meter 10 or shaped riser h 10 cm linear meter 15

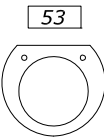

53
POCRI10
L 62 P 52 H 1,5
only one tap hole Sx - Dx

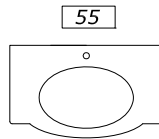

55
POCRI49
L 82 P 52/39 H 1,5

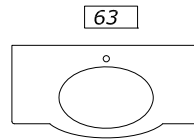

63
POCRI50
L 102 P 52/39 H 1,5

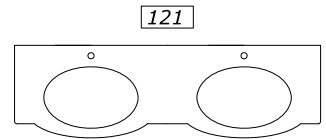

121
POCRI51
L 187 P 52/39 H 1,5

MARBLE TOP

for one undertop - overtop washbasin INCREASE +25% THICKNESS CM.3

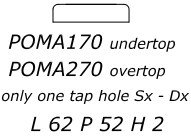

POMA170 undertop
POMA270 overtop
only one tap hole Sx - Dx
L 62 P 52 H 2

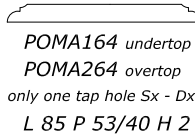

POMA164 undertop
POMA264 overtop
only one tap hole Sx - Dx
L 85 P 53/40 H 2

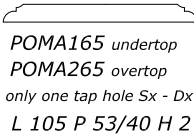

POMA165 undertop
POMA265 overtop
only one tap hole Sx - Dx
L 105 P 53/40 H 2

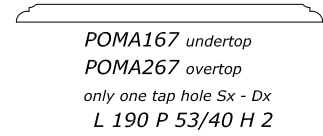

POMA167 undertop
POMA267 overtop
only one tap hole Sx - Dx
L 190 P 53/40 H 2

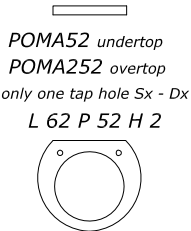

POMA52 undertop C1 19
POMA252 overtop C2 23
only one tap hole Sx - Dx C3 28
L 62 P 52 H 2 C4 30
C5 34

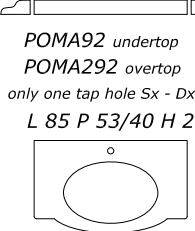

POMA92 undertop C1 26
POMA292 overtop C2 33
only one tap hole Sx - Dx C3 40
L 85 P 53/40 H 2 C4 44
C5 48

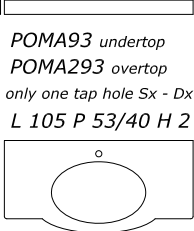

POMA93 undertop C1 32
POMA293 overtop C2 39
only one tap hole Sx - Dx C3 49
L 105 P 53/40 H 2 C4 53
C5 59

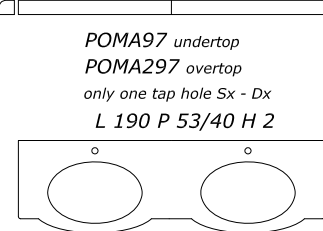

POMA97 undertop C1 58
POMA297 overtop C2 73
only one tap hole Sx - Dx C3 89
L 190 P 53/40 H 2 C4 97
C5 107

MIRRORS

increase outline relief metal finish 5



40
SP 2353
L 63/40 H 108



46
SP 252
L 71/60 H 90

increase outline relief metal finish 5

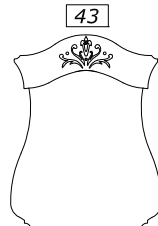

43
SP 2357
L 85/62 H 108

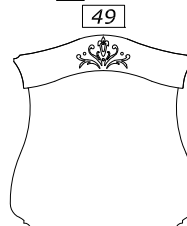

49
SP 2358
L 105/82 H 108

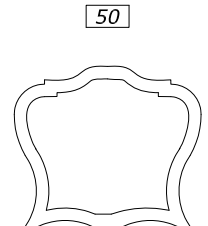

50
SP 250
L 93/82 H 90

ACCESORIES

increase outline relief metal finish 10

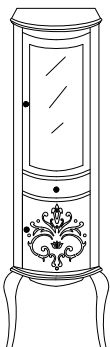

141
VT 2357 Sx-Dx
L 53 P 41 H 178
two doors
one drawer

increase outline relief metal finish 20

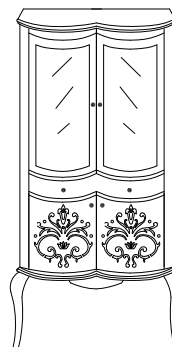

276
VT 2358
L 94 P 42 H 178
four doors
one drawer

STANDARD RELIEF OUTLINE SAME COLOR AND FINISH OF THE FURNITURE -MIRROR-CABINET **A PRICE LIST**
ON DEMAND RELIEF OUTLINE 4 METALLI ONLY FOR FINISHES NF-ND-RM-AT-PT-LC 21 COLORS **WITH INCREASE**

RILIEVI

MY

INTERNAL BOTTOM DRAWER - BIG DRAWER AND DOOR 'S COATING

STANDARD LACE AND ECO-LEATHER CORD SAME AS HANDLES **OR/CO/BR**

ON DEMAND CHOOSE COLOR LACE OR ECOLEATHER AND CORD ECOLEATHER **A PRICE LIST**

LINDEN WOOD

MAKEUP CORE central

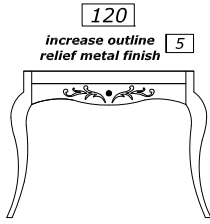

MO 2321
L 106 P 50/37 H 83
one big drawer

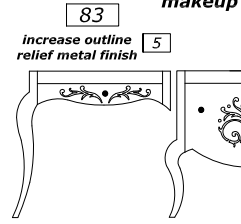

MO 2322 sx
L 74 P 34/31 H 83
one big drawer

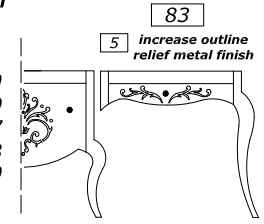

MO 2322 dx
L 74 P 34/31 H 83
one big drawer

MAKEUP CORE

match it with cores or
makeup core central

- MO 2320
- MO 2349
- MO 2357
- MO 2358
- MO 2359
- MO 2321

WOOD TOP

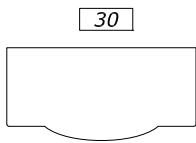

POLEG2329
L 105 P 53/40 H 2

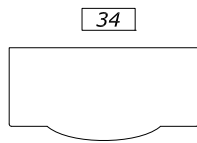

POCRI63
L 102 P 52/39 H 1,5

CRYSTAL TOP

INCREASE +10% WAVE MANUFACTURE -
OPTIONAL linear riser h 4 cm linear meter 10 or shaped rider h 10 cm linear meter 15 MAX LENGTH 2,25ml

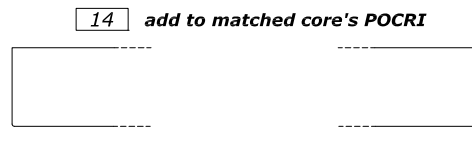

POCRI64 dx/sx
L 73 P 36 H 1,5

MARBLE TOP

INCREASE +25% THICKNESS CM.3 MAX LENGTH L 2,25 ml

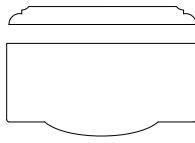

POMA143
L 105 P 53/40 H 2

- C1 28
- C2 35
- C3 45
- C4 49
- C5 55



POMA144 dx/sx
L 74 P 36 H 2

- C1 19
- C2 24
- C3 31
- C4 34
- C5 38

MIRRORS

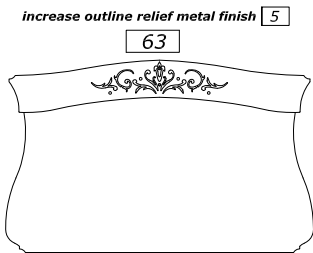

SP 2354
L 175/150 H 108

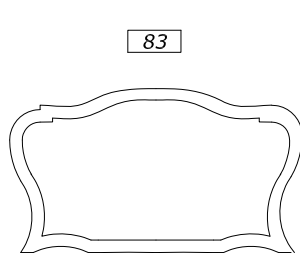

SP 267
L 150/140 H 90

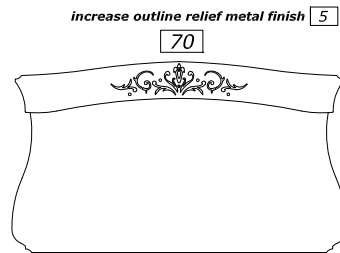

SP 2359
L 195/170 H 108

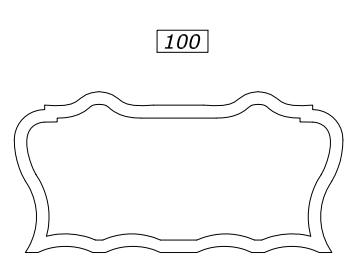

SP 263
L 180/168 H 90

ACCESSORIES

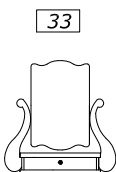

CD 94
L 68 P 20 H 60
PETTINEUSE
one drawer

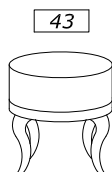

CD 72
L 43 P 43 H 46
pouf seat
ecoleather smooth



CD 73
L 43 P 43 H 46
pouf seat
ecoleather capitonné

FINISH'S INCREASE



ONECOLOR-BICOLOR

NERO F.-ROSSO M.-NOCE D.	PRICE LIST
ANTICATO 21 colors	PRICE LIST
PATINATO 21 colors	PRICE LIST
ANTICATO 4 metals	10%
PATINATO 4 metals	10%
LACCATO 21 colors	10%
BRILLANTE 21 colors	20%
MADREPERLA 21 colors	20%
FOGLIA oro/argento	10%
FOGLIA PATINATA oro/arg	10%

Knob Q

IMPORTANT
COMPATIBLE WITH
WASHBASIN OF MAX SIZE
LA 63 - LA 64

PEREMPTORY 1°COLOR INTERNAL AND EXTERNAL OF DOORS , DRAWERS , BIG DRAWERS UPPER CORE AND MIRROR.
BICOLOR 2°COLOR INTERNAL AND EXTERNAL OF FURNITURE STRUCTURE - CABINET.
ON DEMAND BICOLOR WITH THE SAME FINISH
PRICE LIST WITH INCREASE FOR THE CHOICE FINISH
ON DEMAND BICOLOR WITH TWO DIFFERENT FINISHES
PRICE LIST WITH INCREASE CALCULATED ON THE HIGHER INCREASE CHOSEN FINISH

UNDERTOP WASHBASIN		OVERTOP WASHBASIN	
8		13	
LA 63	WHITE	LA 64	BLACK
internal 36,5x51,5 esternal 41x56		internal 38 esternal 40	

PEREMPTORY WITH MARBLE TOP LA 63 - LA 64

INSTALL SIPHON WITH OVERALL LESS THAN CM. 9

CORE

for one or two undertop - overtop washbasin

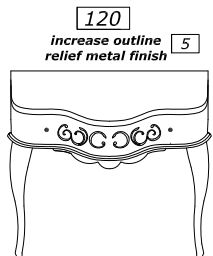

MO 2328
L 106 P 58/41 H 82
one big drawer

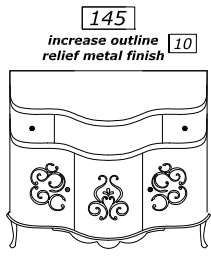

MO 2365
L 106 P 58/41 H 82
three doors
two drawers

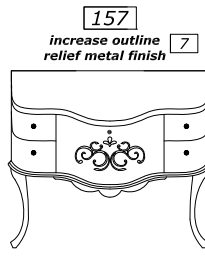

MO 2364
L 106 P 58/41 H 82
one big drawer
four drawers

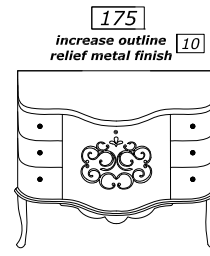

MO 2366
L 106 P 58/41 H 82
one big drawer
six drawers

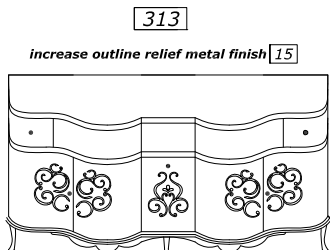

MO 2367
L 174 P 58/41 H 82
four doors
one basket
two drawers

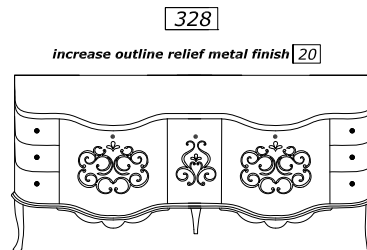

MO 2368
L 189 P 58/41 H 82
two big drawers
one basket
six drawers

CERAMIC TOP

except of CORE MO 2328

CRYSTAL TOP

with washbasin INCREASE +10% WAVE MANUFACTURE -
OPTIONAL linear riser h 4 cm linear meter 10 or shaped riser h 10 cm linear meter 15

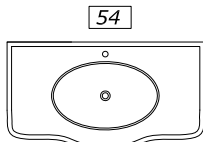

POCER59
L 110 P 61 H 4

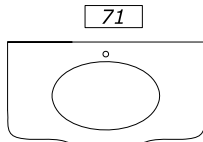

POCRI60
L 105 P 59/42 H 1,5

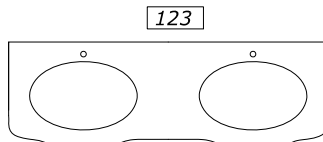

POCRI61
L 173 P 59/42 H 1,5

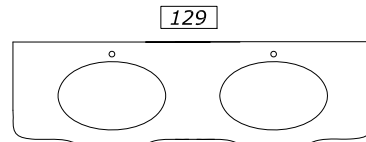

POCRI62
L 189 P 59/41 H 1,5

MARBLE TOP

for one undertop - overtop washbasin INCREASE +25% THICKNESS CM.3

POMA109 undertop
POMA209 overtop
L 107 P 60/43 H 2

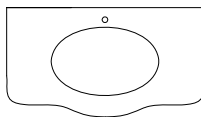

C1	33	C1	54
C2	41	C2	67
C3	51	C3	82
C4	56	C4	89
C5	62	C5	100

POMA100 undertop
POMA200 overtop
L 175 P 60/43 H 2

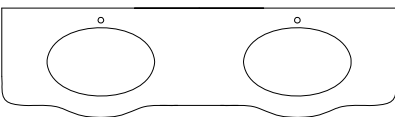

POMA101 undertop
POMA201 overtop
L 192 P 60/43 H 2

C1	58
C2	72
C3	88
C4	96
C5	108

MIRROR

increase outline relief metal finish 5

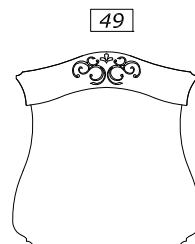

SP 2365
L 105/82 H 108

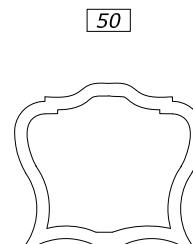

SP 250
L 93/82 H 90

ACCESSORIES

increase outline relief metal finish 10

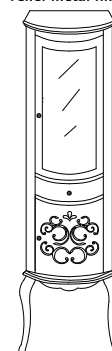

VT 2365 Sx-Dx
L 53 P 41 H 178
two doors
one drawer

STANDARD RELIEF OUTLINE SAME COLOR AND FINISH OF THE FURNITURE -MIRROR-CABINET **A PRICE LIST**
ON DEMAND RELIEF OUTLINE 4 METALLI ONLY FOR FINISHES NF-ND-RM-AT-PT-LC 21 COLORS **WITH INCREASE**

RILIEVI

MY

INTERNAL BOTTOM DRAWER - BIG DRAWER AND DOOR 'S COATING

STANDARD LACE AND ECO-LEATHER CORD SAME AS HANDLES **OR/CO/BR**
ON DEMAND CHOOSE COLOR LACE OR ECOLEATHER AND CORD ECOLEATHER **A PRICE LIST**

LINDEN WOOD

MAKEUP CORE central

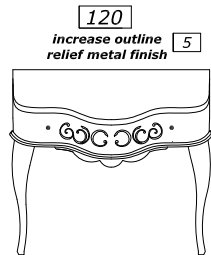

MO 2327
L 106 P 58/41 H 82
one big drawer



MO 2326 sx
L 76 P 35 H 83
one big drawer

MAKEUP CORE

match it with cores or
makeup core central

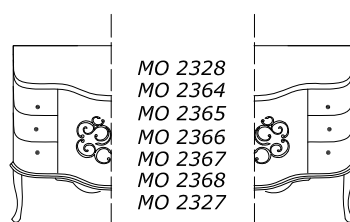

- MO 2328
- MO 2364
- MO 2365
- MO 2366
- MO 2367
- MO 2368
- MO 2327

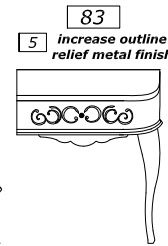

MO 2326 dx
L 76 P 35 H 83
one big drawer

WOOD TOP



POLEG2315
L 107 P 60/43 H 2



POCRI65
L 106 P 59/42 H 1,5

CRYSTAL TOP

INCREASE +10% WAVE MANUFACTURE -

OPTIONAL linear riser h 4 cm linear meter **10** or shaped rider h 10 cm linear meter **15** **MAX LENGTH 2,25ml**

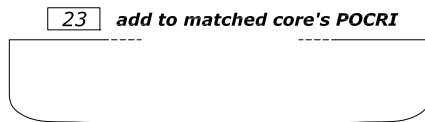

POCRI66 dx/sx
L 77 P 37 H 1,5

MARBLE TOP

INCREASE +25% THICKNESS CM.3 MAX LENGTH L 2,25 ml

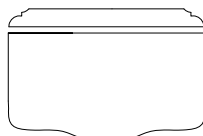

POMA108
L 107 P 60/43 H 2



POMA113 dx/sx
L 77 P 37 H 2

MIRRORS

increase outline relief metal finish **5**

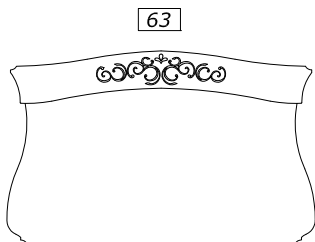

SP 2367
L 175/150 H 108

increase outline relief metal finish **5**

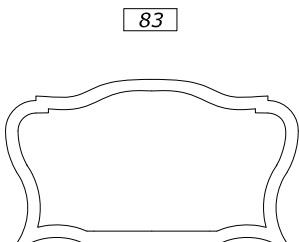

SP 267
L 150/140 H 90

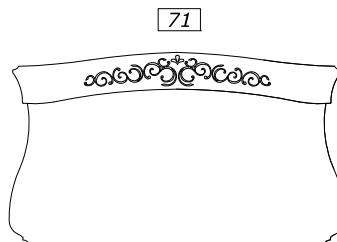

SP 2368
L 195/170 H 108

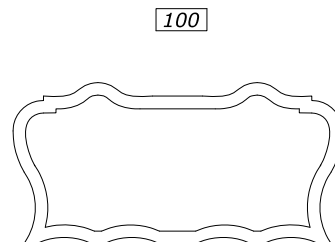

SP 263
L 180/168 H 90

ACCESSORIES

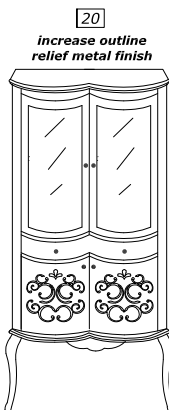

VT 2366
L 94 P 42 H 178
**four doors
one drawer**

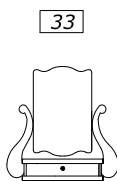

CD 94
L 68 P 20 H 60
**PETTINEUSE
one drawer**

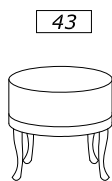

CD 74
L 43 P 43 H 46
**pouf seat
ecoleather smooth**

increase for swarovski **6**

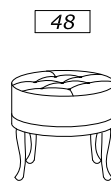

CD 75
L 43 P 43 H 46
**pouf seat
ecoleather capitonné**

**FINISH'S INCREASE
ONECOLOR-BICOLOR**

NERO F.-ROSSO M.-NOCE D.	PRICE LIST
ANTICATO 21 colors	PRICE LIST
PATINATO 21 colors	PRICE LIST
ANTICATO 4 metals	10%
PATINATO 4 metals	10%
LACCATO 21 colors	10%
BRILLANTE 21 colors	20%
MADREPERLA 21 colors	20%
FOGLIA oro/argento	10%
FOGLIA PATINATA oro/arg	10%

CAPITONNÈ

Knob Q

IMPORTANT
COMPATIBLE WITH
WASHBASIN OF MAX SIZE
LA 63 - LA 64

UNDERTOP WASHBASIN [8] LA 63 WHITE [13] LA 64 BLACK internal 36,5x51,5 external 41x56		OVERTOP WASHBASIN [27] FOGLIA Similgold LA 50 [27] FOGLIA Similsilver LA 51 LA 52 internal 38 external 40	
---	--	---	--

PEREMPTORY WITH MARBLE TOP LA 63 - LA 64
INSTALL SIPHON WITH OVERALL LESS THAN CM. 9

CORE

for one or two undertop - overtop washbasin

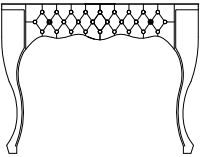
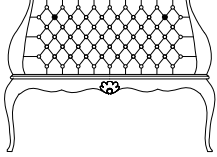
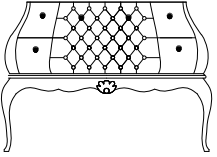
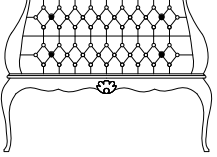
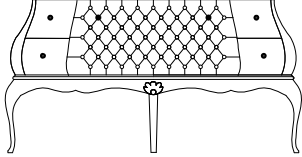
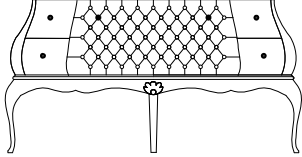
<p>[160] swarovski increase [5]</p>  <p>MO 2337 L 130/110 P 64 H 83 one big drawer</p>	<p>[252] swarovski increase [15]</p>  <p>MO 2330 L 132/119 P 56 H 83 one big drawer</p>	<p>[335] swarovski increase [10]</p>  <p>MO 2332 L 132/119 P 56 H 83 one big drawer four drawers</p>	<p>[328] swarovski increase [12]</p>  <p>MO 2331 L 132/119 P 56 H 83 two big drawers</p>	<p>[415] swarovski increase [15]</p>  <p>MO 2333 one washbasin L 185/172 P 63 H 83 one big drawer four drawers</p>	<p>[387] swarovski increase [15]</p>  <p>MO 2334 two washbasins L 185/172 P 63 H 83 one big drawer two drawers</p>
--	--	---	--	---	---

CRYSTAL TOP

with washbasin INCREASE +10% WAVE MANUFACTURE - OPTIONAL linear riser h 4 cm linear meter [10] or shaped riser h 10 cm linear meter [15]

<p>[80]</p>  <p>POCRI93 L 133/113 P 66 H 1,5</p>	<p>[76]</p>  <p>POCRI90 L 121/89 P 57 H 1,5</p>	<p>[97]</p>  <p>POCRI91 L 174/146 P 65 H 1,5</p>	<p>[123]</p>  <p>POCRI92 L 174/146 P 65 H 1,5</p>
--	--	--	--

MARBLE TOP

for one or two undertop - overtop washbasin INCREASE +25% THICKNESS CM.3

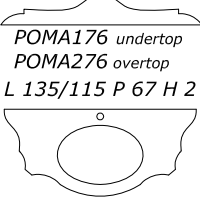
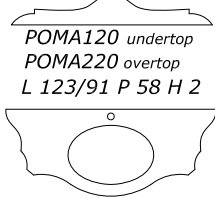
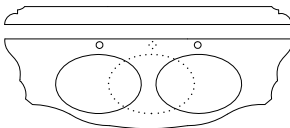
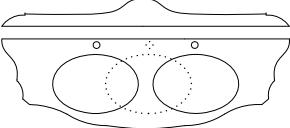
<p>POMA175 undertop POMA275 overtop L 135/115 P 67 H 2</p> <p>C1 [39] C2 [48] C3 [59] C4 [65] C5 [73]</p> 	<p>POMA160 undertop POMA260 overtop L 123/91 P 58 H 2</p> <p>C1 [35] C2 [44] C3 [54] C4 [59] C5 [66]</p> 	<p>POMA161 for 1 undertop POMA261 for 1 overtop POMA162 for 2 undertop POMA262 for 2 overtop L 177/148 P 65 H 2</p> 	<p>POMA184 for 1 undertop POMA284 for 1 overtop POMA186 for 2 undertop POMA286 for 2 overtop L 177/148 P 65 H 2</p>  <p>C1 [52] C2 [64] C3 [79] C4 [87] C5 [97]</p>
--	--	--	--

MIRRORS

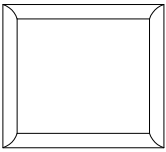
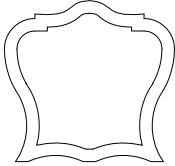
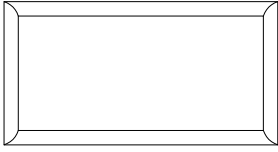
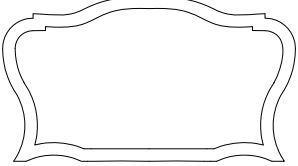
<p>(ECOLEATHER)</p> <p>[37]</p>  <p>SP 2569 L 90 H 80</p>	<p>(WOOD)</p> <p>[50]</p>  <p>SP 250 L 93/82 H 90</p>	<p>(ECOLEATHER)</p> <p>[50]</p>  <p>SP 2561 L 153 H 80</p>	<p>(WOOD)</p> <p>[83]</p>  <p>SP 267 L 150/140 H 90</p>
--	--	--	--

ACCESSORIES

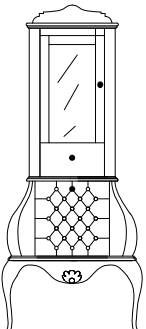
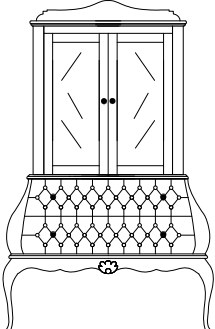
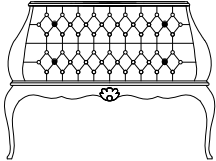
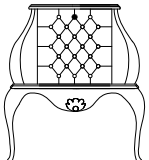
<p>swarovski increase [7]</p>  <p>[235] VT 2330 Sx-Dx L 70/62 P 38 H 180 one door one drawer one big drawer</p>	<p>swarovski increase [12]</p>  <p>[456] VT 2332 L 132/119 P 38 H 180 two doors two big drawers</p>	<p>swarovski increase [12]</p>  <p>[331] VT 2333 L 132/119 P 38 H 85 two big drawers</p>	<p>swarovski increase [7]</p>  <p>[152] VT 2331 L 70/53 P 38 H 85 one big drawer</p>
---	--	--	---

STANDARD CAPITONNE' AND BOTTONS ECOLEATHER SAME COLOR
ON DEMAND BOTTONS ECOLEATHER DIFFERENT COLOR **A PRICE LIST**
ON DEMAND BOTTONS SWAROVSKI **WITH INCREASE**

CAPITONNE' MY

INTERNAL BOTTOM DRAWER - BIG DRAWER AND DOOR 'S COATING
STANDARD LACE AND ECO-LEATHER CORD SAME AS HANDLES **OR/CO/BR**
ON DEMAND CHOOSE COLOR LACE OR ECOLEATHER AND CORD ECOLEATHER **A PRICE LIST**

LINDEN WOOD

MAKEUP CORE central

MAKEUP CORE
*match it with cores or
 makeup core central*

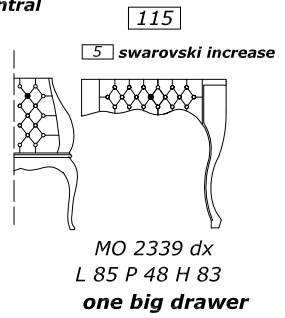
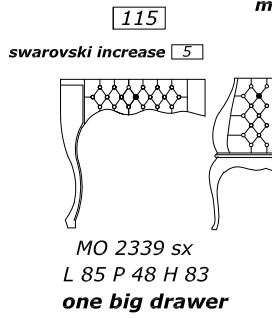
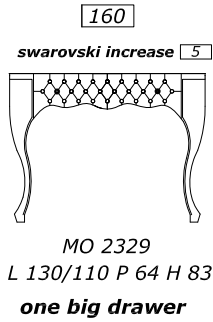

WOOD TOP

CRYSTAL TOP

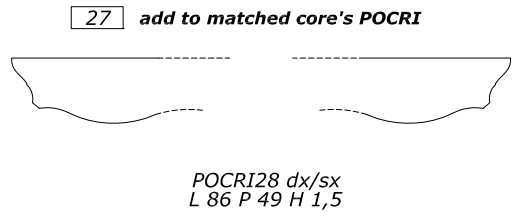
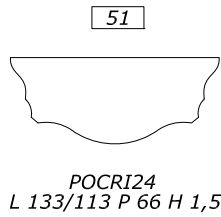
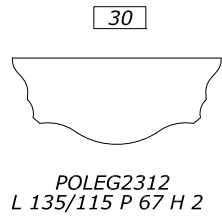

INCREASE +10% WAVE MANUFACTURE -
OPTIONAL linear riser h 4 cm linear meter 10 or shaped rider h 10 cm linear meter 15 MAX LENGTH 2,25ml

MARBLE TOP

INCREASE +25% THICKNESS CM.3 MAX LENGTH L 2,25 ml

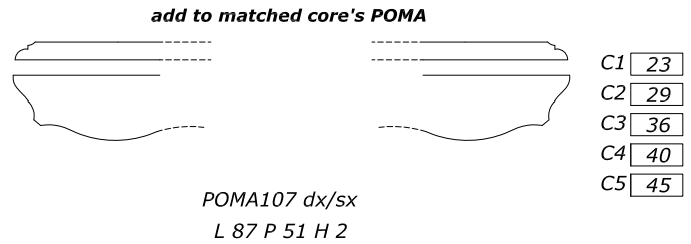
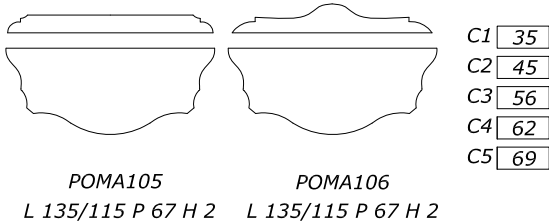

MIRRORS

(ECOLEATHER)

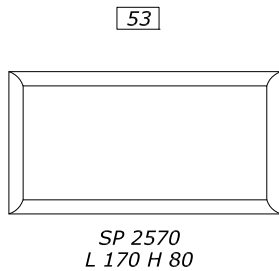

(WOOD)

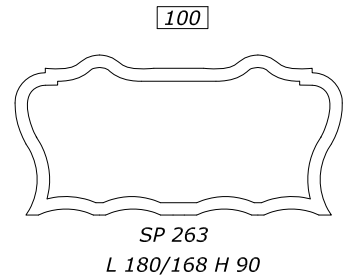

ACCESSORIES

**FINISH'S INCREASE
 ONECOLOR-BICOLOR**

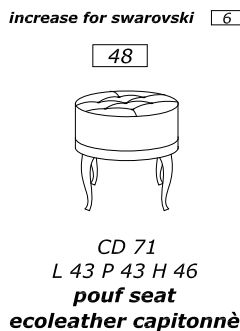
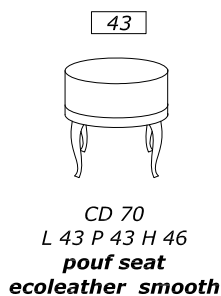
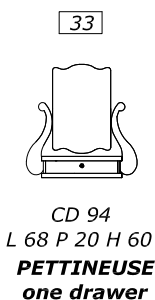

NERO F.-ROSSO M.-NOCE D.	PRICE LIST
PATINATO 21 colors	PRICE LIST
PATINATO 4 metals	10%
LACCATO 21 colors	10%
BRILLANTE 21 colors	20%
MADREPERLA 21 colors	20%
FOGLIA oro/argento	10%
FOGLIA PATINATA oro/arg	10%

Knob Q

IMPORTANT
COMPATIBLE WITH
WASHBASIN OF MAX SIZE
LA 63 - LA 64

UNDERTOP WASHBASIN		OVERTOP WASHBASIN	
8 LA 63 WHITE		13 LA 64 BLACK	
internal 36,5x51,5 esternal 41x56		internal 38 esternal 40	

PEREMPATORY WITH MARBLE TOP LA 63 - LA 64
INSTALL SIPHON WITH OVERALL LESS THAN CM. 9

CORE

for one or two undertop - overtop washbasin

160

swarovski increase 5

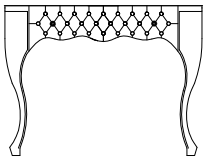

MO 2337

L 130/110 P 64 H 83
one big drawer

284

swarovski increase 14

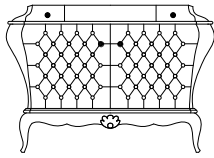

MO 2335

L 132/110 P 60 H 82
two doors
two drawers

346

swarovski increase 12

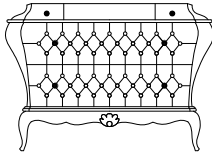

MO 2336

L 132/110 P 60 H 82
two big drawers
two drawers

363

swarovski increase 14

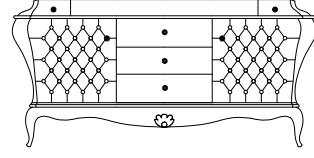

MO 2338

L 176/152 P 60 H 82
two doors
three drawers

CRYSTAL TOP

with washbasin INCREASE +10% WAVE MANUFACTURE - OPTIONAL linear riser h 4 cm linear meter 10 or shaped riser h 10 cm linear meter 15

80

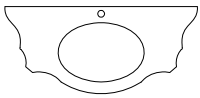

POCRI93

L 133/115 P 66 H 1,5

76

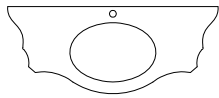

POCRI40

L 123/104 P 59 H 1,5

92

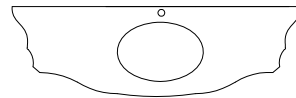

POCRI41

L 166/148 P 59 H 1,5

123

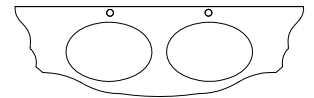

POCRI42

L 166/148 P 59 H 1,5

MARBLE TOP

for one or two undertop - overtop washbasin INCREASE +25% THICKNESS CM.3

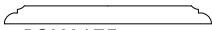

POMA175 undertop
POMA275 overtop
L 135/115 P 67 H 2

- C1 39
- C2 48
- C3 59
- C4 65
- C5 73

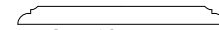

POMA194 undertop
POMA294 overtop
L 124/105 P 59 H 2

- C1 36
- C2 45
- C3 56
- C4 61
- C5 68

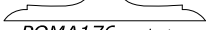

POMA176 undertop
POMA276 overtop
L 135/115 P 67 H 2

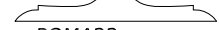

POMA222 undertop
POMA222 overtop
L 124/105 P 59 H 2

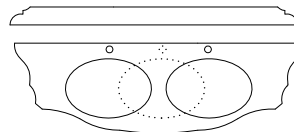

POMA195 for 1 undertop
POMA295 for 1 overtop
POMA196 for 2 undertops
POMA296 for 2 overtops
L 167/149 P 59 H 2

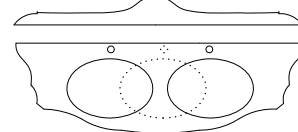

POMA12 for 1 undertop
POMA212 for 1 overtop
POMA63 for 2 undertops
POMA263 for 2 overtops
L 167/149 P 59 H 2

- C1 50
- C2 62
- C3 76
- C4 83
- C5 93

MIRRORS

(ECOLEATHER)

37

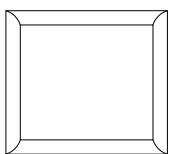

SP 2569
L 90 H 80

(WOOD)

50

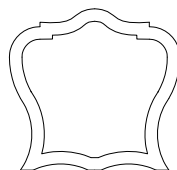

SP 250
L 93/82 H 90

(ECOLEATHER)

50

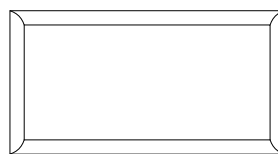

SP 2561
L 153 H 80

(WOOD)

83

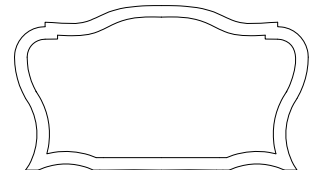

SP 267
L 150/140 H 90

ACCESSORIES

swarovski increase 7

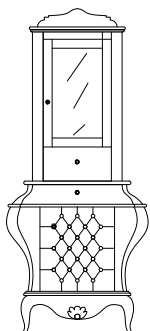

235

VT 2335 Sx-Dx
L 71/53 P 38 H 180
two doors
two drawers

swarovski increase 12

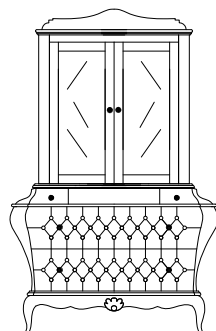

473

VT 2337
L 132/110 P 38 H 180
two doors
two drawers
two big drawers

swarovski increase 12

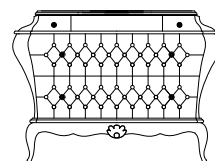

348

VT 2338
L 132/110 P 38 H 85
two big drawers
two drawers

swarovski increase 7

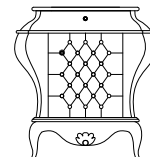

152

VT 2336 Sx-Dx
L 71/53 P 38 H 85
one door
one drawer

STANDARD CAPITONNE' AND BOTTONS ECOLEATHER SAME COLOR
ON DEMAND BOTTONS ECOLEATHER DIFFERENT COLOR **A PRICE LIST**
ON DEMAND BOTTONS SWAROVSKI **WITH INCREASE**

CAPITONNE'

MY

INTERNAL BOTTOM DRAWER - BIG DRAWER AND DOOR 'S COATING
STANDARD LACE AND ECO-LEATHER CORD SAME AS HANDLES **OR/CO/BR**
ON DEMAND CHOOSE COLOR LACE OR ECOLEATHER AND CORD ECOLEATHER **A PRICE LIST**

LINDEN WOOD

MAKEUP CORE central

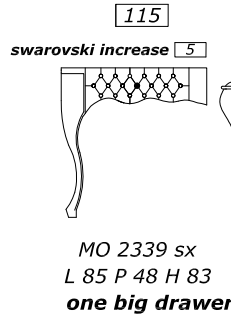
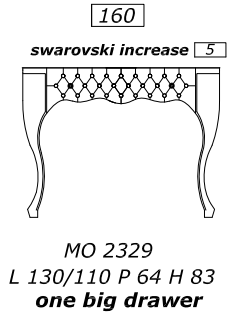

MAKEUP CORE
 match it with cores or
 makeup core central

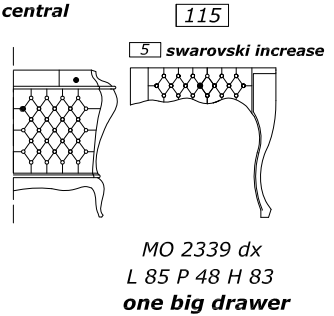

WOOD TOP

CRYSTAL TOP

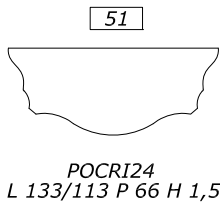
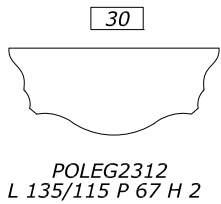

INCREASE +10% WAVE MANUFACTURE -
OPTIONAL linear riser h 4 cm linear meter 10 or shaped rider h 10 cm linear meter 15 MAX LENGTH 2,25ml

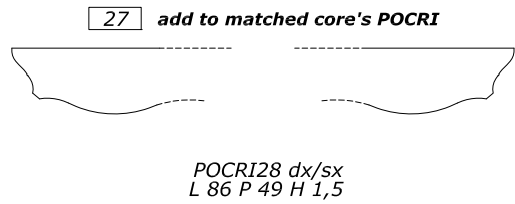

MARBLE TOP

INCREASE +25% THICKNESS CM.3 MAX LENGTH L 2,25 ml

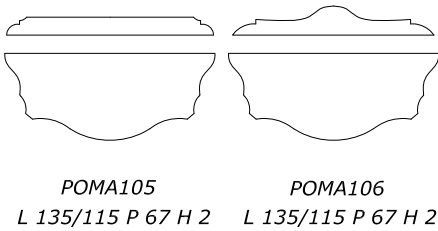

- C1 35
- C2 45
- C3 56
- C4 62
- C5 69

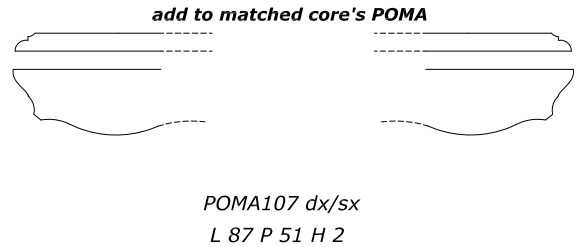

- C1 23
- C2 29
- C3 36
- C4 40
- C5 45

MIRRORS

(ECOLEATHER)

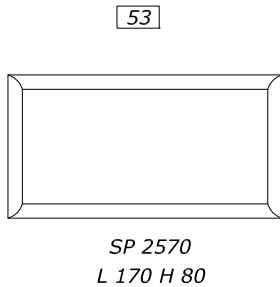

(WOOD)

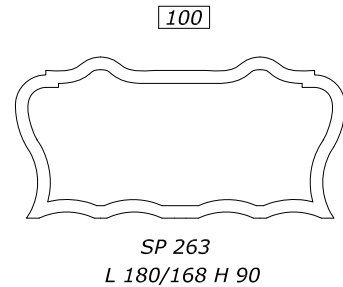

ACCESSORIES

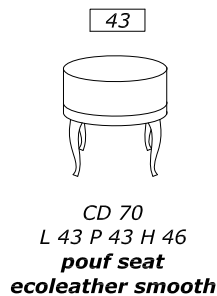
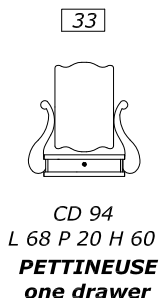

increase for swarovski 6

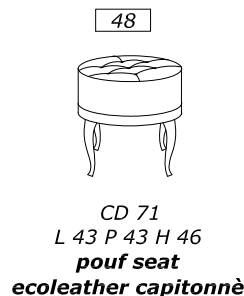

FINISH'S INCREASE
ONECOLOR-BICOLOR

NERO F.-ROSSO M.-NOCE D.	PRICE LIST
PATINATO 21 colors	PRICE LIST
PATINATO 4 metals	10%
LACCATO 21 colors	10%
BRILLANTE 21 colors	20%
MADREPERLA 21 colors	20%
FOGLIA oro/argento	10%
FOGLIA PATINATA oro/arg	10%

Knob Q

IMPORTANT
COMPATIBLE WITH
WASHBASIN OF MAX SIZE
LA 63 - LA 64

UNDERTOP WASHBASIN 8 LA 63 WHITE 13 LA 64 BLACK internal 36,5x51,5 external 41x56		OVERTOP WASHBASIN 27 FOGLIA Similgold LA 50 27 FOGLIA Similsilver LA 51 LA 52 internal 38 external 40	
--	--	--	--

PEREMPATORY WITH MARBLE TOP LA 63 - LA 64
INSTALL SIPHON WITH OVERALL LESS THAN CM. 9

CORE

for one undertop - overtop washbasin

224

swarovski increase 9

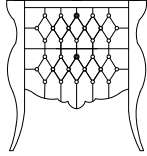

MO 2557
L 90/72 P 58 H 83
two big drawers

179

swarovski increase 5

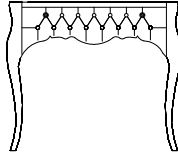

MO 2554
L 115/95 P 58 H 83
one big drawer

235

swarovski increase 11

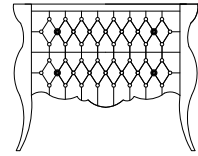

MO 2560
L 115/95 P 58 H 83
two big drawers

CRYSTAL TOP

with washbasin INCREASE +10% WAVE MANUFACTURE - OPTIONAL linear riser h 4 cm linear meter 10 or shaped riser h 10 cm linear meter 15

57

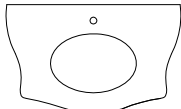

POCRI15
L 89/75 P 58 H 1,5

74

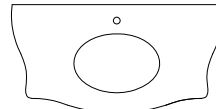

POCRI43
L 113/99 P 58 H 1,5

MARBLE TOP

for one undertop - overtop washbasin INCREASE +25% THICKNESS CM.3

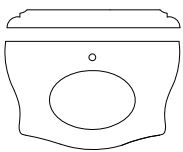

POMA118 undertop
POMA218 overtop
L 91/77 P 59 H 2

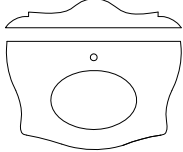

POMA119 undertop
POMA219 overtop
L 91/77 P 59 H 2

- C1 27
- C2 33
- C3 41
- C4 45
- C5 50

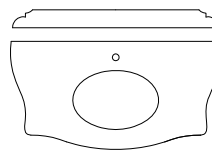

POMA139 undertop
POMA239 overtop
L 116/100 P 59 H 2

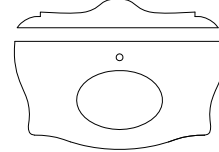

POMA24 undertop
POMA224 overtop
L 116/100 P 59 H 2

- C1 35
- C2 44
- C3 53
- C4 59
- C5 66

MIRRORS

(ECOLEATHER)

35

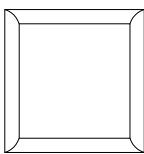

SP 2563
L 78 H 80

(WOOD)

46

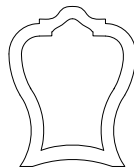

SP 252
L 71/60 H 90

(ECOLEATHER)

39

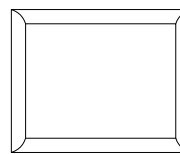

SP 2560
L 100 H 80

(WOOD)

50

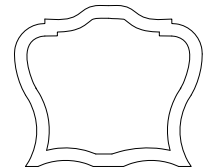

SP 250
L 93/82 H 90

ACCESSORIES

7

swarovski increase

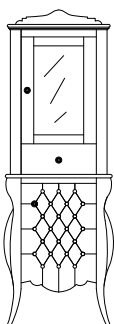

218
VT 2560 Sx-Dx
L 65/53 P 38 H 180
two doors
one drawer

11

swarovski increase

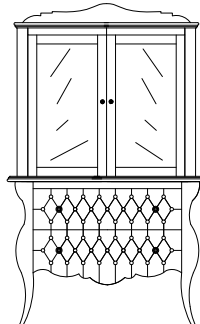

364
VT 2562
L 106/100 P 41 H 180
two doors
two big drawers

swarovski increase 11

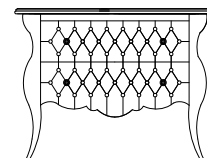

239
VT 2559
L 106/100 P 41 H 85
two big drawers

swarovski increase 7

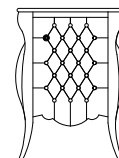

135
VT 2561 Sx-Dx
L 65/53 P 38 H 85
one door

STANDARD CAPITONNE' AND BOTTONS ECOLEATHER SAME COLOR
ON DEMAND BOTTONS ECOLEATHER DIFFERENT COLOR **A PRICE LIST**
ON DEMAND BOTTONS SWAROVSKI **WITH INCREASE**

CAPITONNE' MY

INTERNAL BOTTOM DRAWER - BIG DRAWER AND DOOR 'S COATING
STANDARD LACE AND ECO-LEATHER CORD SAME AS HANDLES **OR/CO/BR**
ON DEMAND CHOOSE COLOR LACE OR ECOLEATHER AND CORD ECOLEATHER **A PRICE LIST**

LINDEN WOOD

MAKEUP CORE central

MAKEUP CORE

match it with cores or
makeup core central

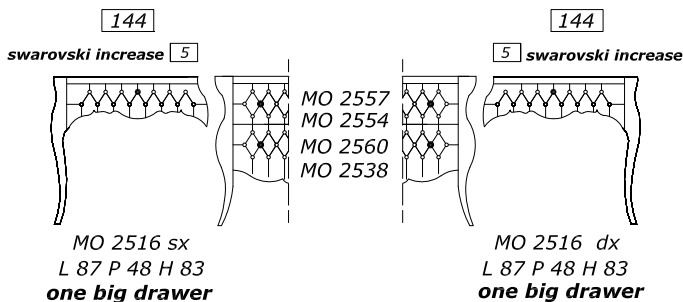
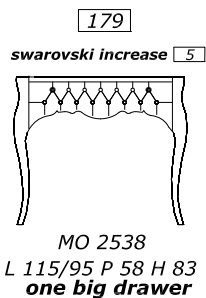

WOOD TOP

CRYSTAL TOP

INCREASE +10% WAVE MANUFACTURE -
OPTIONAL linear riser h 4 cm linear meter 10 or shaped rider h 10 cm linear meter 15 MAX LENGTH 2,25ml

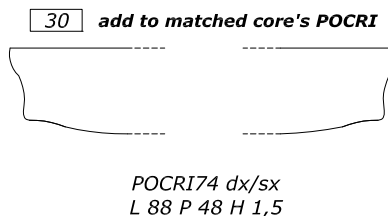
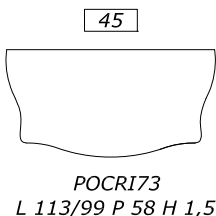
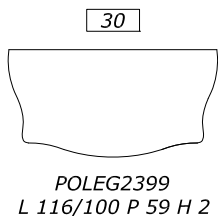

MARBLE TOP

INCREASE +25% THICKNESS CM.3 MAX LENGTH L 2,25 ml
add to matched core's POMA

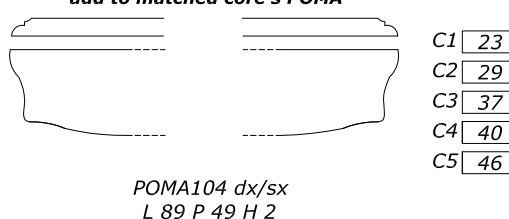
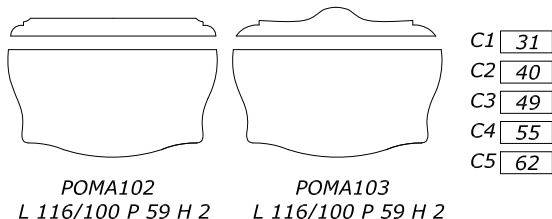

MIRRORS

(ECOLEATHER)

(WOOD)

(ECOLEATHER)

(WOOD)

50

83

56

100

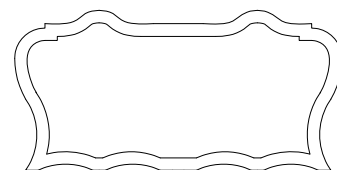
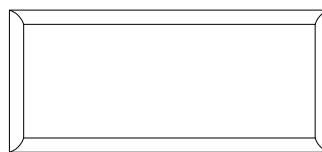
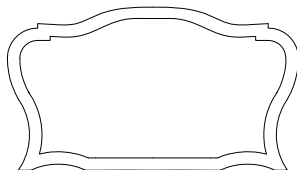
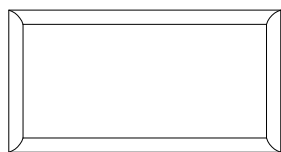

SP 2561
L 153 H 80

SP 267
L 150/140 H 90

SP 2562
L 180 H 80

SP 263
L 180/168 H 90

ACCESSORIES

FINISH'S INCREASE
ONECOLOR-BICOLOR

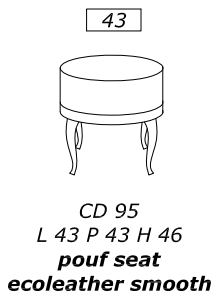
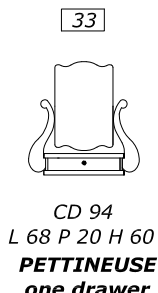

increase for swarovski 6

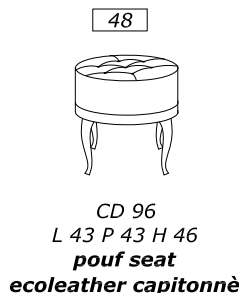

NERO F.-ROSSO M.-NOCE D.	PRICE LIST
PATINATO 21 colors	PRICE LIST
LACCATO 21 colors	10%
PATINATO 4 metals	10%
BRILLANTE 21 colors	15%
MADREPERLA 21 colors	15%
FOGLIA oro/argento	15%
FOGLIA PATINATA oro/arg	15%

Knob Q

IMPORTANT
COMPATIBLE WITH
WASHBASIN OF MAX SIZE
LA 63 - LA 64

UNDERTOP WASHBASIN		OVERTOP WASHBASIN	
8		13	
LA 63 WHITE		LA 64 BLACK	
Internal 36,5x51,5 esternal 41x56		internal 38 esternal 40	

PEREMPTORY WITH MARBLE TOP LA 63 - LA 64
INSTALL SIPHON WITH OVERALL LESS THAN CM. 9

CORE

for one or two undertop - overtop washbasin

300

swarovski increase 18

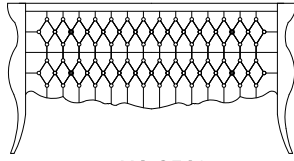

MO 2561
L 173/153 P 58 H 83
two big drawers

415

swarovski increase 22

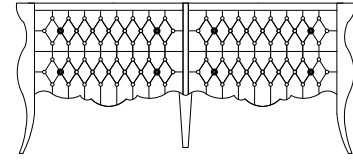

MO 2562
L 203/182 P 58 H 83
four big drawers

CRYSTAL TOP

with washbasin INCREASE +10% WAVE MANUFACTURE - OPTIONAL linear riser h 4 cm linear meter 10 or shaped riser h 10 cm linear meter 15

92

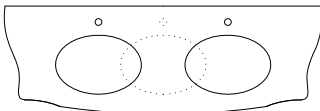

POCRI44 for 1 washbasin
L 172/156 P 58 H 1,5

123

POCRI45 for 2 washbasins
L 172/156 P 58 H 1,5

137

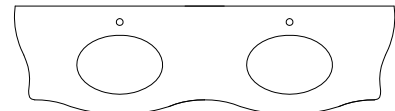

POCRI46
L 200/185 P 58 H 1,5

MARBLE TOP

for one or two undertop - overtop washbasin INCREASE +25% THICKNESS CM.3

POMA116 one undertop

POMA115 two undertops

POMA216 one overtop

POMA215 two overtops

L 173/157 P 59 H 2

C1 51

C2 63

C3 79

C4 86

C5 97

POMA04 one undertop

POMA02 two undertops

POMA204 one overtop

POMA202 two overtops

L 173/157 P 59 H 2

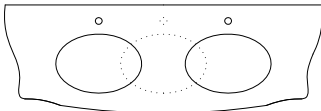

POMA117 undertop

POMA217 overtop

L 202/186 P 59 H 2

C1 62

C2 76

C3 94

C4 103

C5 115

POMA43 undertop

POMA243 overtop

L 202/186 P 59 H 2

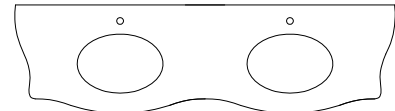

MIRRORS

(ECOLEATHER)

50

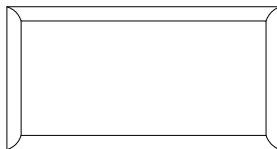

SP 2561
L 153 H 80

(WOOD)

83

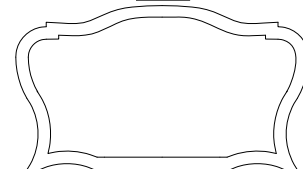

SP 267
L 150/140 H 90

ACCESSORIES

7

swarovski increase

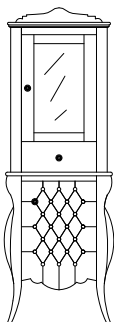

218

VT 2560 Sx-Dx
L 65/53 P 38 H 180
two doors
one drawer

11

swarovski increase

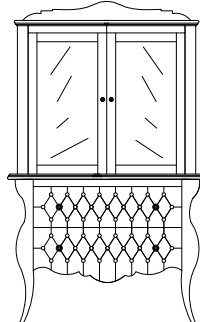

364

VT 2562
L 106/100 P 41 H 180
two doors
two big drawers

swarovski increase 11

239

VT 2559
L 106/100 P 41 H 85
two big drawers

swarovski increase 7

135

VT 2561 Sx-Dx
L 65/53 P 38 H 85
one door

STANDARD CAPITONNE' AND BOTTONS ECOLEATHER SAME COLOR
ON DEMAND BOTTONS ECOLEATHER DIFFERENT COLOR **A PRICE LIST**
ON DEMAND BOTTONS SWAROVSKI **WITH INCREASE**

CAPITONNE' MY
 LINDEN WOOD

INTERNAL BOTTOM DRAWER - BIG DRAWER AND DOOR 'S COATING
STANDARD LACE AND ECO-LEATHER CORD SAME AS HANDLES **OR/CO/BR**
ON DEMAND CHOOSE COLOR LACE OR ECOLEATHER AND CORD ECOLEATHER **A PRICE LIST**

MAKEUP CORE central

MAKEUP CORE

match it with cores or
makeup core central

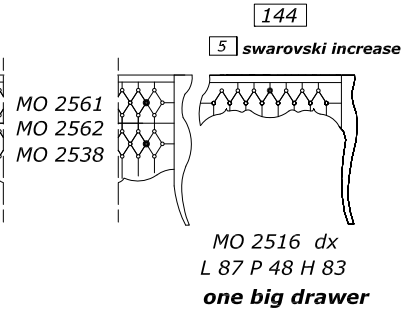
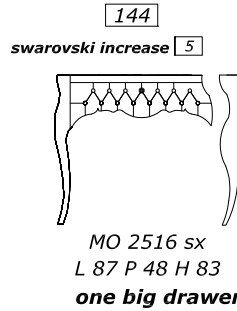
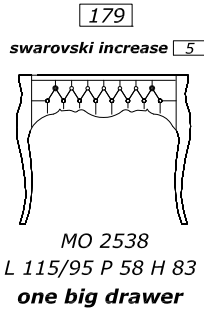

WOOD TOP

CRYSTAL TOP

INCREASE +10% WAVE MANUFACTURE -
OPTIONAL linear riser h 4 cm linear meter 10 or shaped rider h 10 cm linear meter 15 MAX LENGTH 2,25ml

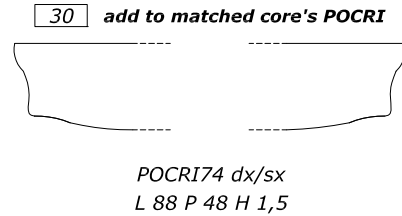
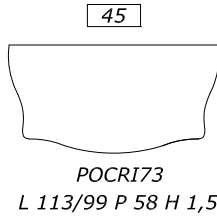
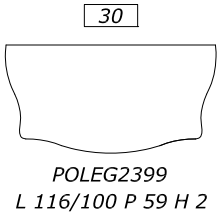

MARBLE TOP

INCREASE +25% THICKNESS CM.3 MAX LENGTH L 2,25 ml

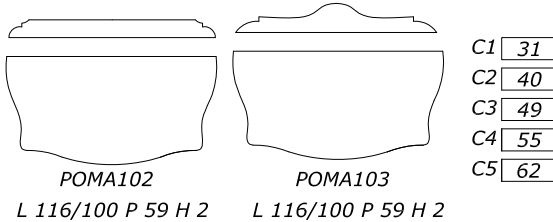

MIRRORS

(ECOLEATHER)

(WOOD)

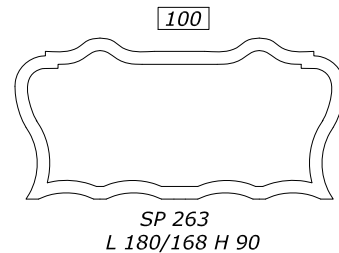
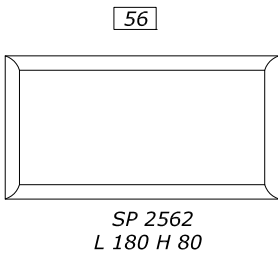

ACCESSORIES

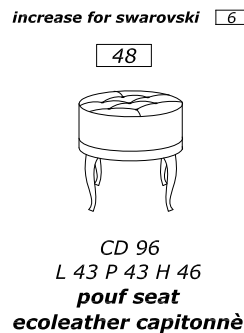
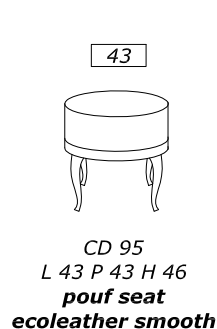

FINISH'S INCREASE
ONECOLOR-BICOLOR

NERO F.-ROSSO M.-NOCE D.	PRICE LIST
PATINATO 21 colors	PRICE LIST
LACCATO 21 colors	10%
PATINATO 4 metals	10%
BRILLANTE 21 colors	15%
MADREPERLA 21 colors	15%
FOGLIA oro/argento	15%
FOGLIA PATINATA oro/arg	15%

Knob Q

IMPORTANT
COMPATIBLE WITH
WASHBASIN OF MAX SIZE
LA 63 - LA 64 - LA 03

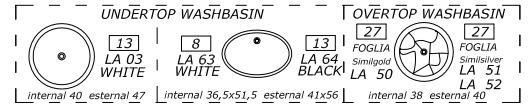

PEREMPORY WITH MARBLE TOP LA 63 - LA 64

INSTALL SIPHON WITH OVERALL LESS THAN CM. 9

CORE

for one or two undertop - overtop washbasin

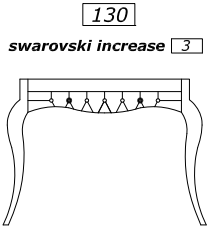

MO 2517
L 106 P 50/37 H 83
one big drawer

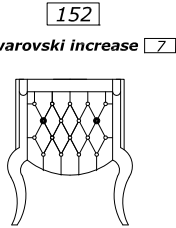

MO 2573
L 63 P 52/37 H 83
one big drawer

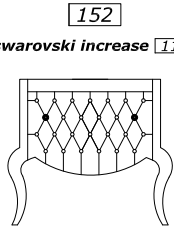

MO 2570
L 84 P 50/37 H 83
one big drawer

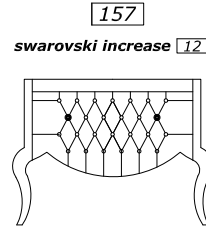

MO 2571
L 104 P 50/37 H 83
one big drawer

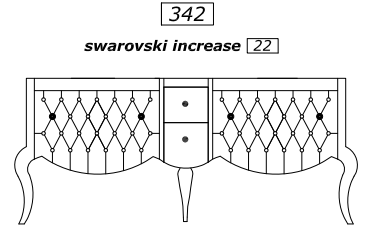

MO 2572
L 190 P 50/37 H 83
two big drawers
two drawer

CERAMIC TOP

except of CORE MO 2517

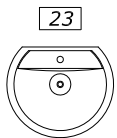

POCER11
L 59 P 52 H 4

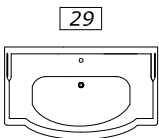

POCER10
L 89 P 55 H 4

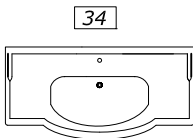

POCER12
L 109 P 55 H 4

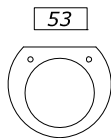

POCRI10
L 62 P 52 H 1,5
only one tap hole Sx - Dx

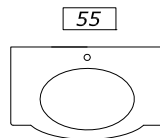

POCRI49
L 82 P 52/39 H 1,5

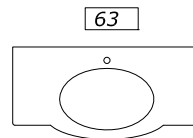

POCRI50
L 102 P 52/39 H 1,5

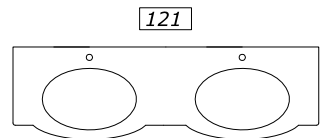

POCRI51
L 187 P 52/39 H 1,5

CRYSTAL TOP

with washbasin INCREASE +10% WAVE MANUFACTURE -
OPTIONAL linear riser h 4 cm linear meter 10 or shaped riser h 10 cm linear meter 15

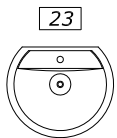

POMA170 undertop
POMA270 overtop
only one tap hole Sx - Dx
L 62 P 52 H 2

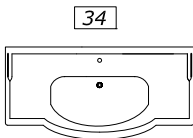

POMA164 undertop
POMA264 overtop
only one tap hole Sx - Dx
L 85 P 53/40 H 2

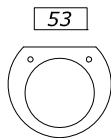

POMA165 undertop
POMA265 overtop
only one tap hole Sx - Dx
L 105 P 53/40 H 2

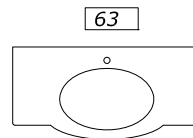

POMA167 undertop
POMA267 overtop
only one tap hole Sx - Dx
L 190 P 53/40 H 2

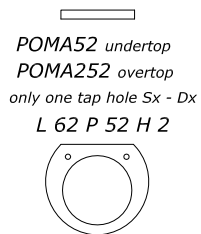

POMA52 undertop C1 19
POMA252 overtop C2 23
only one tap hole Sx - Dx C3 28
L 62 P 52 H 2 C4 30
C5 34

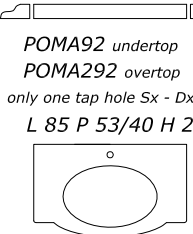

POMA92 undertop C1 26
POMA292 overtop C2 33
only one tap hole Sx - Dx C3 40
L 85 P 53/40 H 2 C4 44
C5 48

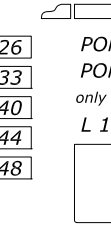

POMA93 undertop C1 32
POMA293 overtop C2 39
only one tap hole Sx - Dx C3 49
L 105 P 53/40 H 2 C4 53
C5 59

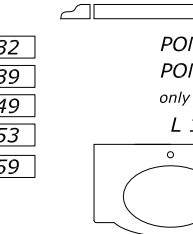

POMA97 undertop C1 58
POMA297 overtop C2 73
only one tap hole Sx - Dx C3 89
L 190 P 53/40 H 2 C4 97
C5 107

MARBLE TOP

for one or two undertop - overtop washbasin INCREASE +25% THICKNESS CM.3

MIRRORS

(ECOLEATHER)

(WOOD)

(ECOLEATHER)

(ECOLEATHER)

(WOOD)

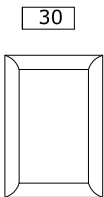

SP 2568
L 55 H 80

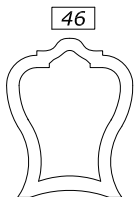

SP 252
L 71/60 H 90

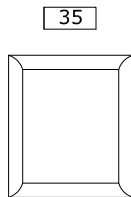

SP 2563
L 70 H 80

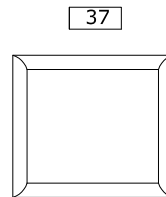

SP 2569
L 90 H 80

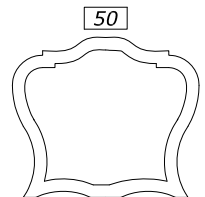

SP 250
L 93/82 H 90

ACCESSORIES

swarovski increase 7

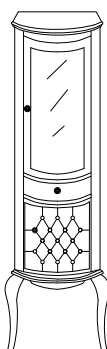

147
VT 2570 Sx-Dx
L 53 P 41 H 178
two doors
one drawer

swarovski increase 14

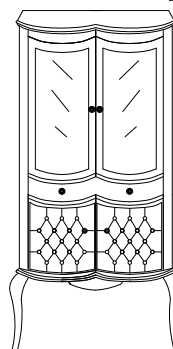

288
VT 2571
L 94 P 42 H 178
four doors
one drawer

STANDARD CAPITONNE' AND BOTTONS ECOLEATHER SAME COLOR
ON DEMAND BOTTONS ECOLEATHER DIFFERENT COLOR **A PRICE LIST**
ON DEMAND BOTTONS SWAROVSKI **WITH INCREASE**

CAPITONNE' MY

INTERNAL BOTTOM DRAWER - BIG DRAWER AND DOOR 'S COATING
STANDARD LACE AND ECO-LEATHER CORD SAME AS HANDLES **OR/CO/BR**
ON DEMAND CHOOSE COLOR LACE OR ECOLEATHER AND CORD ECOLEATHER **A PRICE LIST**

LINDEN WOOD

MAKEUP CORE central

MAKEUP CORE

match it with cores or
makeup core central

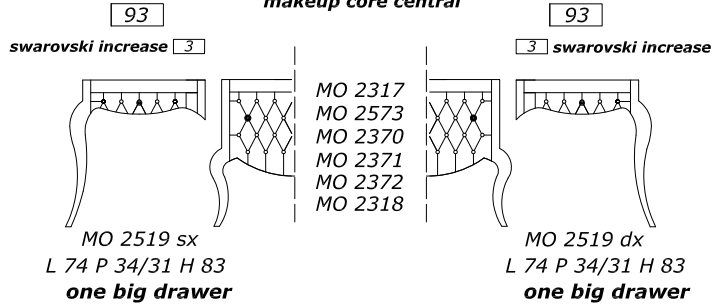
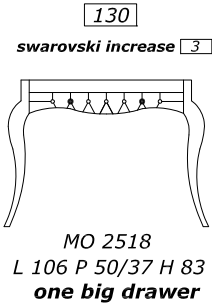

WOOD TOP

CRYSTAL TOP

INCREASE +10% WAVE MANUFACTURE -

OPTIONAL linear riser h 4 cm linear meter 10 or shaped rider h 10 cm linear meter 15 MAX LENGTH 2,25ml

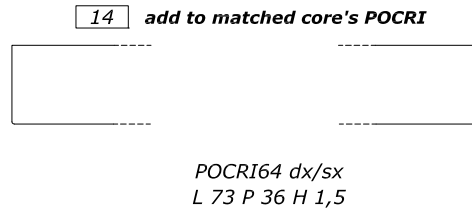
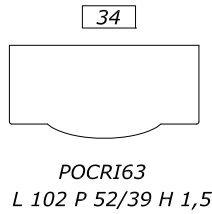
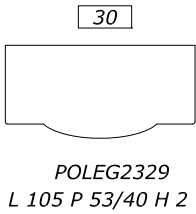

MARBLE TOP

INCREASE +25% THICKNESS CM.3 MAX LENGTH L 2,25 ml

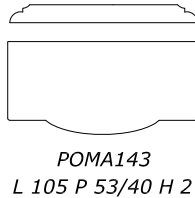

- C1 28
- C2 35
- C3 45
- C4 49
- C5 55

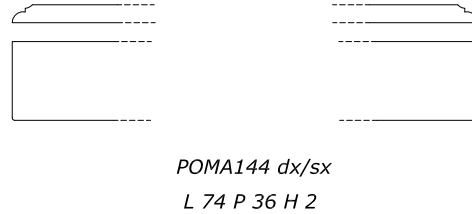

- C1 19
- C2 24
- C3 31
- C4 34
- C5 38

MIRRORS

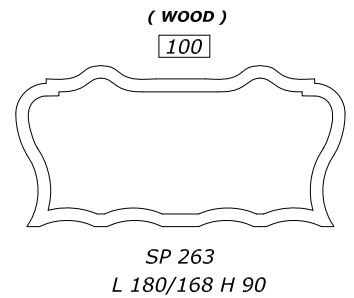
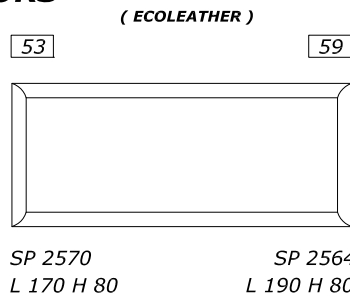
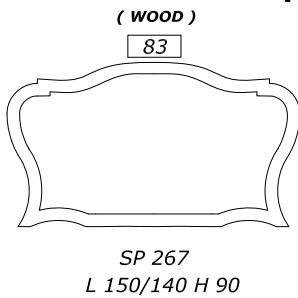
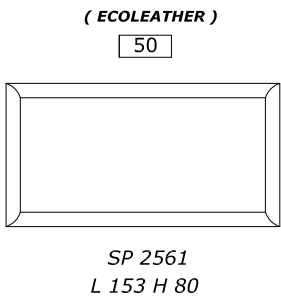

ACCESSORIES

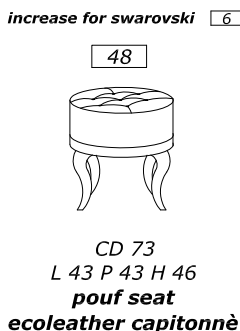
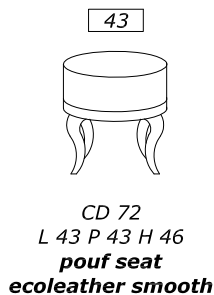
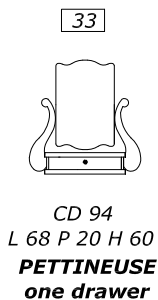

FINISH'S INCREASE
ONECOLOR-BICOLOR

NERO F.-ROSSO M.-NOCE D.	PRICE LIST
PATINATO 21 colors	PRICE LIST
PATINATO 4 metals	20%
LACCATO 21 colors	10%
BRILLANTE 21 colors	20%
MADREPERLA 21 colors	20%
FOGLIA oro/argento	10%
FOGLIA PATINATA oro/arg	10%

Knob Q

IMPORTANT
COMPATIBLE WITH
WASHBASIN OF MAX SIZE
LA 63 - LA 64

UNDERTOP WASHBASIN 8 LA 63 WHITE 13 LA 64 BLACK internal 36,5x51,5 external 41x56		OVERTOP WASHBASIN 27 FOGLIA Similtgola LA 50 27 FOGLIA Similsilver LA 51 LA 52 internal 38 external 40	
--	--	---	--

PEREMPATORY WITH MARBLE TOP LA 63 - LA 64
INSTALL SIPHON WITH OVERALL LESS THAN CM. 9

CORE

for one or two undertop - overtop washbasin

139

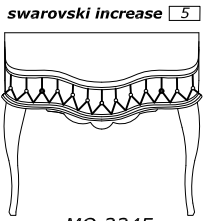

MO 2345
L 106 P 58/41 H 82
one big drawer

223

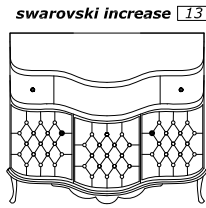

MO 2340
L 106 P 58/41 H 82
**three doors
two drawers**

167

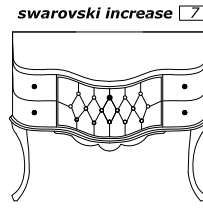

MO 2344
L 106 P 58/41 H 82
**one big drawer
four drawers**

194

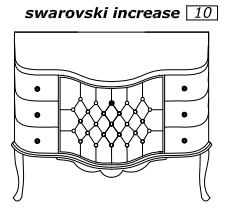

MO 2341
L 106 P 58/41 H 82
**one big drawer
six drawers**

414

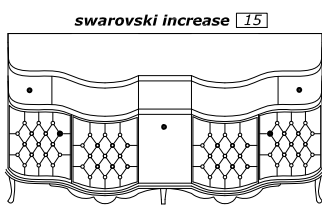

MO 2342
L 174 P 58/41 H 82
**four doors
one basket
two drawers**

372

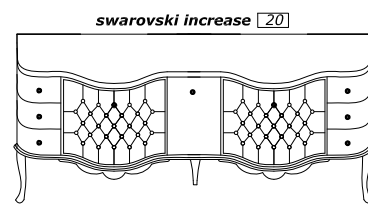

MO 2343
L 189 P 58/41 H 82
**two big drawers
one basket
six drawers**

CERAMIC TOP

except of CORE MO 2345

54

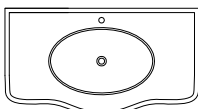

POCER59
L 110 P 61 H 4

CRYSTAL TOP

with washbasin INCREASE +10% WAVE MANUFACTURE -
OPTIONAL linear riser h 4 cm linear meter 10 or shaped riser h 10 cm linear meter 15

71

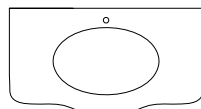

POCRI60
L 105 P 59/42 H 1,5

123

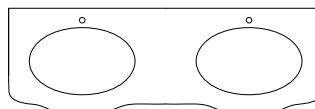

POCRI61
L 173 P 59/42 H 1,5

129



POCRI62
L 189 P 59/41 H 1,5

MARBLE TOP

for one undertop - overtop washbasin INCREASE +25% THICKNESS CM.3



POMA109 undertop
POMA209 overtop
L 107 P 60/43 H 2

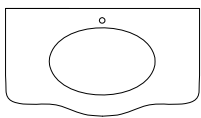

- | | | | |
|----|----|----|-----|
| C1 | 33 | C1 | 54 |
| C2 | 41 | C2 | 67 |
| C3 | 51 | C3 | 82 |
| C4 | 56 | C4 | 89 |
| C5 | 62 | C5 | 100 |



POMA100 undertop
POMA200 overtop
L 175 P 60/43 H 2

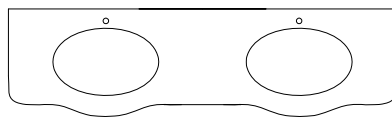

- | | |
|----|-----|
| C1 | 58 |
| C2 | 72 |
| C3 | 88 |
| C4 | 96 |
| C5 | 108 |

MIRRORS

(ECOLEATHER)

37

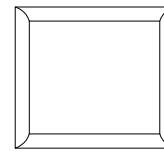

SP 2569
L 90 H 80

(WOOD)

50

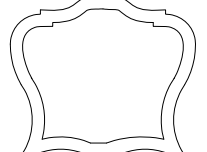

SP 250
L 93/82 H 90

ACCESSORIES

swarovski increase 7

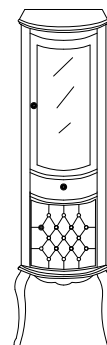

147

VT 2340 Sx-Dx
L 53 P 41 H 178
**two doors
one drawer**

STANDARD CAPITONNE' AND BOTTONS ECOLEATHER SAME COLOR
ON DEMAND BOTTONS ECOLEATHER DIFFERENT COLOR **A PRICE LIST**
ON DEMAND BOTTONS SWAROVSKI **WITH INCREASE**

CAPITONNE' MY

INTERNAL BOTTOM DRAWER - BIG DRAWER AND DOOR 'S COATING
STANDARD LACE AND ECO-LEATHER CORD SAME AS HANDLES **OR/CO/BR**
ON DEMAND CHOOSE COLOR LACE OR ECOLEATHER AND CORD ECOLEATHER **A PRICE LIST**

LINDEN WOOD

MAKEUP CORE central

MAKEUP CORE

match it with cores or
makeup core central

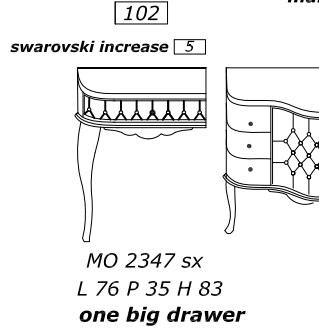
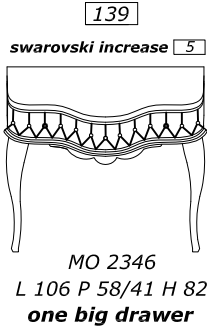

MO 2345
MO 2340
MO 2344
MO 2341
MO 2342
MO 2343
MO 2346

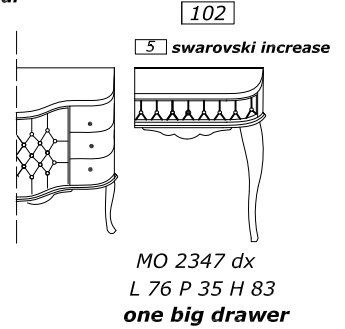

WOOD TOP

CRYSTAL TOP

INCREASE +10% WAVE MANUFACTURE -
OPTIONAL linear riser h 4 cm linear meter 10 or shaped rider h 10 cm linear meter 15 MAX LENGTH 2,25ml

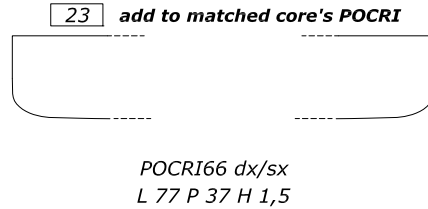
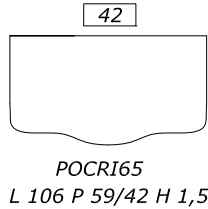
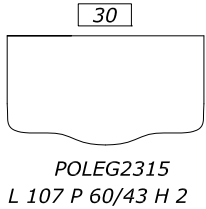

MARBLE TOP

INCREASE +25% THICKNESS CM.3 MAX LENGTH L 2,25 ml

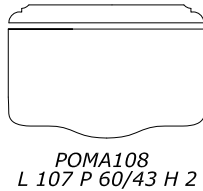

C1 29
C2 37
C3 47
C4 52
C5 58

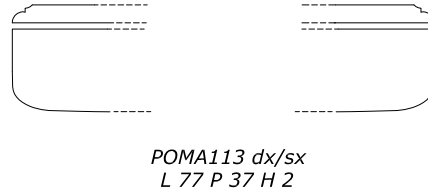

C1 20
C2 25
C3 32
C4 35
C5 40

MIRRORS

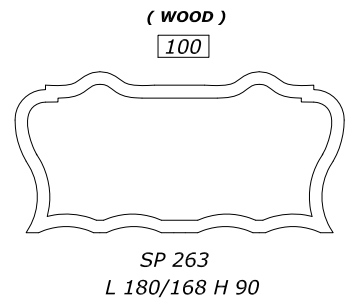
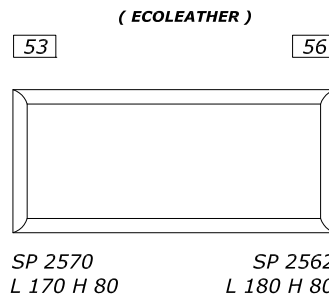
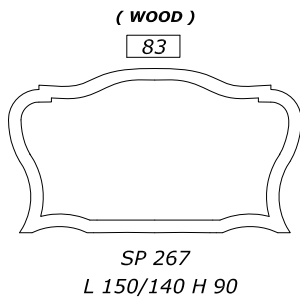
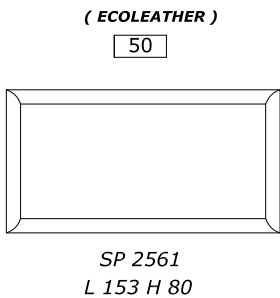

ACCESSORIES

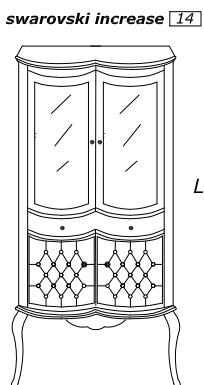

288

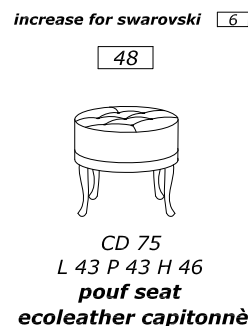
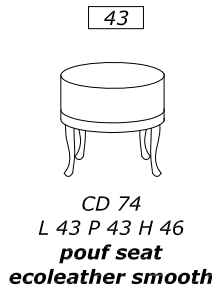
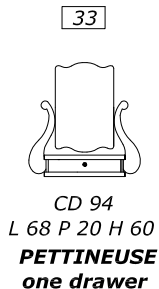

**FINISH'S INCREASE
ONECOLOR-BICOLOR**

NERO F.-ROSSO M.-NOCE D.	PRICE LIST
PATINATO 21 colors	PRICE LIST
PATINATO 4 metals	10%
LACCATO 21 colors	10%
BRILLANTE 21 colors	20%
MADREPERLA 21 colors	20%
FOGLIA oro/argento	10%
FOGLIA PATINATA oro/arg	10%

DECORATI

Knob W

**IMPORTANT
COMPATIBLE WITH
WASHBASIN OF MAX SIZE
LA 63 - LA 64**

ROSE



STELLE

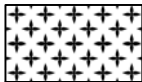

LETTERE



DAMASCATO



INTERNAL BOTTOM DRAWER - BIG DRAWER AND DOOR 'S COATING
STANDARD LACE AND ECO-LEATHER CORD SAME AS HANDLES **OR/CO/BR**
ON DEMAND CHOOSE COLOR LACE OR ECOLEATHER AND CORD ECOLEATHER **A PRICE LIST**

UNDERTOP WASHBASIN		OVERTOP WASHBASIN	
8 LA 63 WHITE		13 LA 64 BLACK	
internal 36,5x51,5 external 41x56		internal 38 external 40	

PEREMPTORY WITH MARBLE TOP LA 63 - LA 64
 INSTALL SIPHON WITH OVERALL LESS THAN CM. 9

CORE

for one or two undertop - overtop washbasin

180

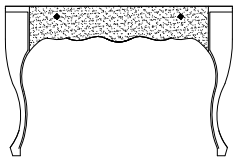

MO 2259
L 130/110 P 64 H 83
one big drawer

295

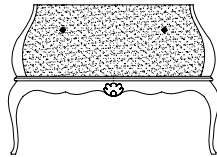

MO 2265
L 132/119 P 56 H 83
one big drawer

373

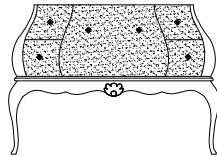

MO 2266
L 132/119 P 56 H 83
one big drawer
four drawers

338

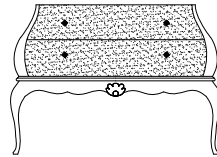

MO 2269
L 132/119 P 56 H 83
two big drawers

482

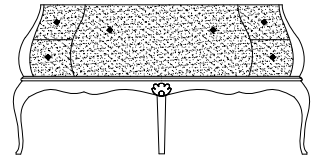

MO 2267one washbasin
L 185/172 P 63 H 83
one big drawer
four drawers

452

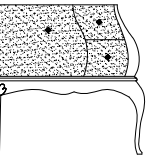

MO 2268 two washbasins
L 185/172 P 63 H 83
one big drawer
two drawers

CRYSTAL TOP

with washbasin **INCREASE +10% WAVE MANUFACTURE - OPTIONAL linear riser h 4 cm linear meter 10 or shaped riser h 10 cm linear meter 15**

80

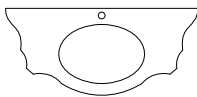

POCRI93
L 133/113 P 66 H 1,5

76

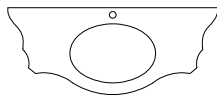

POCRI90
L 121/89 P 57 H 1,5

97

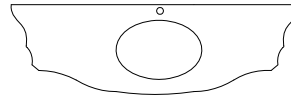

POCRI91
L 174/146 P 65 H 1,5

123

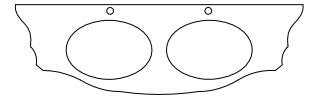

POCRI92
L 174/146 P 65 H 1,5

MARBLE TOP

for one or two undertop - overtop washbasin **INCREASE +25% THICKNESS CM.3**

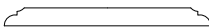

POMA175 undertop
POMA275 overtop
L 135/115 P 67 H 2

C1 39

C2 48

C3 59

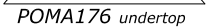

POMA176 undertop
POMA276 overtop
L 135/115 P 67 H 2

C4 65

C5 73

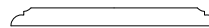

POMA160 undertop
POMA260 overtop
L 123/91 P 58 H 2

C1 35

C2 44

C3 54

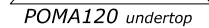

POMA120 undertop
POMA220 overtop
L 123/91 P 58 H 2

C4 59

C5 66

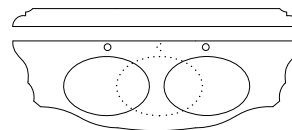

POMA161 for 1 undertop
POMA261 for 1 overtop
POMA162 for 2 undertop
POMA262 for 2 overtop
L 177/148 P 65 H 2

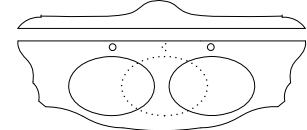

POMA184 for 1 undertop
POMA284 for 1 overtop
POMA186 for 2 undertop
POMA286 for 2 overtop
L 177/148 P 65 H 2

C1 52

C2 64

C3 79

C4 87

C5 97

MIRRORS

50

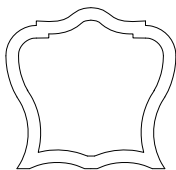

SP 250
L 93/82 H 90

83

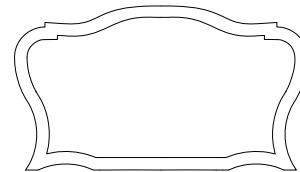

SP 267
L 150/140 H 90

ACCESSORIES

286

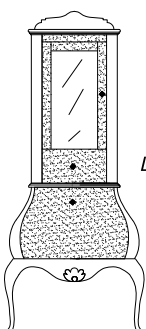

VT 2265 Sx-Dx
L 70/65 P 38 H 180
one door
one drawer
one big drawer

465

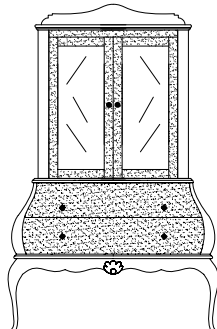

VT 2266
L 132/119 P 38 H 180
two doors
two big drawers

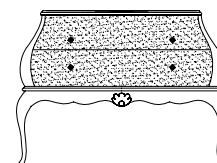

340
VT 2267
L 132/119 P 38 H 85
two big drawers

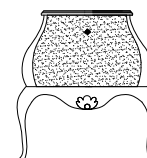

165
VT 2263
L 70/53 P 38 H 85
one big drawer

STANDARD DECORATI

DECOR ON FRONT PART and SIDES **EXCEPT** LEG , CORE'S FRAME and MIRROR
 choose 1) decor 2) decor's color 3) background's color for core and mirror

ON DEMAND DECORATI " TRILOGY "

DECOR ONLY ON THE FRONT PART OF **1°COLOR** **EXCEPT** SIDES , LEGS , CORE'S FRAME , MIRROR

1°COLOR INTERNAL AND EXTERNAL OF DOORS, DRAWERS, BIG DRAWERS AND MIRROR.
2°COLOR INTERNAL AND EXTERNAL OF FURNITURE STRUCTURE - CABINET.

CHOOSE A) decor and decor's color B) 1° color and 2° color

DECORATI

MY

LINEED WOOD

MAKEUP CORE central

MAKEUP CORE
 match it with cores or
 makeup core central

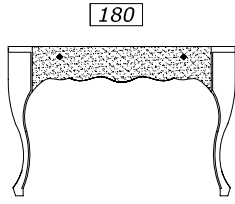

MO 2263
 L 130/110 P 64 H 83
 one big drawer

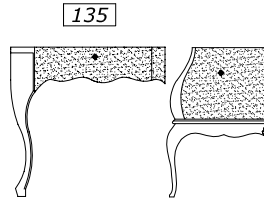

MO 2264 sx
 L 85 P 48 H 83
 one big drawer

MO 2259
 MO 2265
 MO 2266
 MO 2269
 MO 2267
 MO 2268
 MO 2263

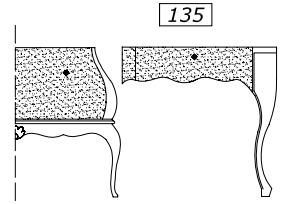

MO 2264 dx
 L 85 P 48 H 83
 one big drawer

WOOD TOP

CRYSTAL TOP

increase +10% WAVE MANUFACTURE -
 OPTIONAL linear riser h4 cm l.m. 10 or raised shaped h 10 cm l.m. 15 MAX LENGTH 2,25ml

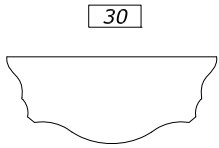

POLEG2312
 L 135/115 P 67 H 2

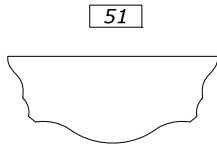

POCRI24
 L 133/113 P 66 H 1,5



POCRI28 dx/sx
 L 86 P 49 H 1,5

27 add to matched core's POCRI

MARBLE TOP

INCREASE +25% THICKNESS CM.3 MAX LENGTH L 2,25 ml

add to matched core's POMA

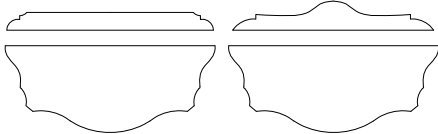

POMA105 L 135/115 P 67 H 2
 POMA106 L 135/115 P 67 H 2

- C1 35
- C2 45
- C3 56
- C4 62
- C5 69



POMA107 dx/sx
 L 87 P 51 H 2

- C1 23
- C2 29
- C3 36
- C4 40
- C5 45

MIRRORS

100

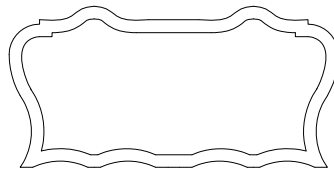

SP 263
 L 180/168 H 90

ACCESSORIES

FINISH'S INCREASE CORE AND ACCESSORIES

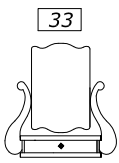

CD 94
 L 68 P 20 H 60
PETTINEUSE
 one drawer



CD 70
 L 43 P 43 H 46
 pouf seat
 ecoleather
 smooth



increase for swarovski 6
 CD 71
 L 43 P 43 H 46
 pouf sat
 ecoleather capitonné

DECORI core & accessories ROSE-STELLE-LETTERE PATINATO 21 colors	PRICE LIST	10%	15%	25%
DECORO core & accessories DAMASCO PATINATO 21 colors	5%	15%	20%	30%
DECORI core and accessories ROSE-STELLE-LETTERE PATINATO 4 metals	10%	20%	25%	35%
DECORO core and accessories DAMASCO PATINATO 4 metals	15%	25%	30%	40%

	PATINATO 4 metals	BRILLANTE PATINATO NERO FUMO-NOCE DORATO ROSSO MODENA PATINATO 21 colors	BRILLANTE PATINATO 4 metals
PRICE LIST	10%	15%	25%
INCREASE MIRRORS without decor			
PRICE LIST	10%	20%	30%

Knob W

**IMPORTANT
COMPATIBLE WITH
WASHBASIN OF MAX SIZE
LA 63 - LA 64**

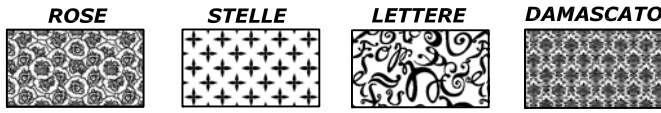

INTERNAL BOTTOM DRAWER - BIG DRAWER AND DOOR 'S COATING
STANDARD LACE AND ECO-LEATHER CORD SAME AS HANDLES **OR/CO/BR**
ON DEMAND CHOOSE COLOR LACE OR ECOLEATHER AND CORD ECOLEATHER **A PRICE LIST**

UNDERTOP WASHBASIN		OVERTOP WASHBASIN	
8 LA 63 WHITE		13 LA 64 BLACK	
internal 36,5x51,5 external 41x56		internal 38 external 40	

PEREMPTORY WITH MARBLE TOP LA 63 - LA 64
 INSTALL SIPHON WITH OVERALL LESS THAN CM. 9

CORE

for one or two undertop - overtop washbasin

180

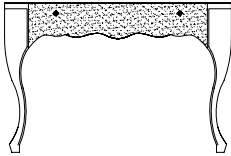

MO 2259
L 130/110 P 64 H 83
one big drawer

290

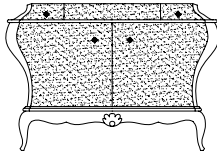

MO 2260
L 132/110 P 60 H 82
**two doors
two drawers**

341

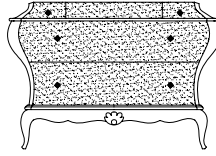

MO 2262
L 132/110 P 60 H 82
**two big drawers
two drawers**

380

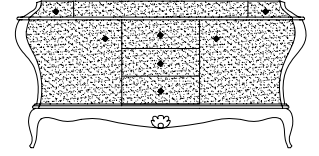

MO 2261
L 176/152 P 60 H 82
**two doors
three drawers**

CRYSTAL TOP

with washbasin **INCREASE +10% WAVE MANUFACTURE - OPTIONAL linear riser h 4 cm linear meter 10 or shaped riser h 10 cm linear meter 15**

80

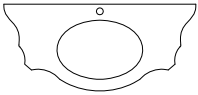

POCRI93
L 133/115 P 66 H 1,5

76

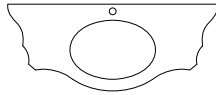

POCRI40
L 123/104 P 59 H 1,5

92

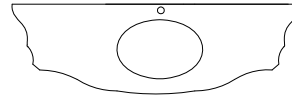

POCRI41
L 166/148 P 59 H 1,5

123

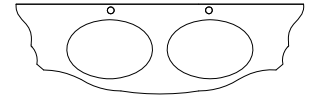

POCRI42
L 166/148 P 59 H 1,5

MARBLE TOP

for one or two undertop - overtop washbasin **INCREASE +25% THICKNESS CM.3**

POMA175 undertop
POMA275 overtop
L 135/115 P 67 H 2

- C1 39
- C2 48
- C3 59
- C4 65
- C5 73

POMA176 undertop
POMA276 overtop
L 135/115 P 67 H 2

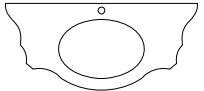

POMA194 undertop
POMA294 overtop
L 124/105 P 59 H 2

- C1 36
- C2 45
- C3 56
- C4 61
- C5 68

POMA22 undertop
POMA222 overtop
L 124/105 P 59 H 2

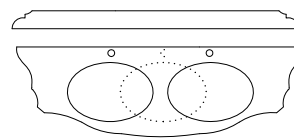
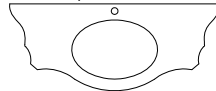

POMA195 for 1 undertop
POMA295 for 1 overtop
POMA196 for 2 undertops
POMA296 for 2 overtops
L 167/149 P 59 H 2

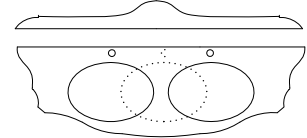

POMA12 for 1 undertop
POMA212 for 1 overtop
POMA63 for 2 undertops
POMA263 for 2 overtops
L 167/149 P 59 H 2

- C1 50
- C2 62
- C3 76
- C4 83
- C5 93

MIRRORS

50

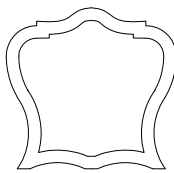

SP 250
L 93/82 H 90

83

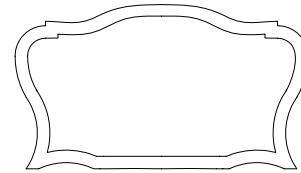

SP 267
L 150/140 H 90

ACCESSORIES

286

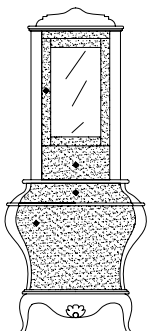

VT 2260 Sx-Dx
L 71/53 P 38 H 180
**two doors
two drawers**

470

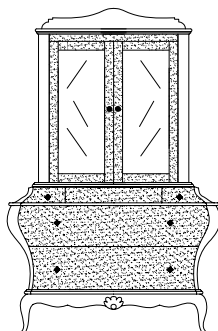

VT 2259
L 132/110 P 38 H 180
**two doors
two drawers
two big drawers**

343

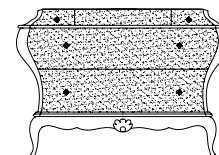

VT 2264
L 132/110 P 38 H 85
**two big drawers
two drawers**

165

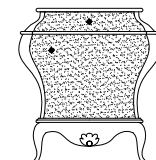

VT 2261 Sx-Dx
L 71/53 P 38 H 85
**one door
one drawer**

STANDARD DECORATI

DECOR ON FRONT PART and SIDES **EXCEPT** LEG , CORE'S FRAME and MIRROR
 choose 1) decor 2) decor's color 3) background's color for core and mirror

ON DEMAND DECORATI " TRILOGY "

DECOR ONLY ON THE FRONT PART OF 1°COLOR **EXCEPT** SIDES , LEGS , CORE'S FRAME , MIRROR

1°COLOR INTERNAL AND EXTERNAL OF DOORS, DRAWERS, BIG DRAWERS UPPER CORE AND MIRROR.

2°COLOR INTERNAL AND EXTERNAL OF FURNITURE STRUCTURE - CABINET.

CHOOSE A) decor and decor's color B) 1° color and 2° color

DECORATI

MY

LINEED WOOD

MAKEUP CORE central

MAKEUP CORE
 match it with cores or
 makeup core central

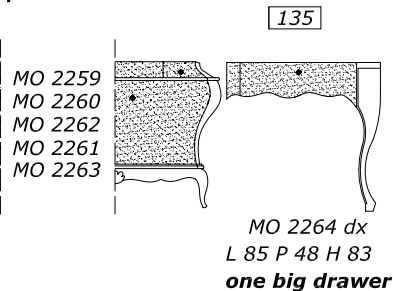
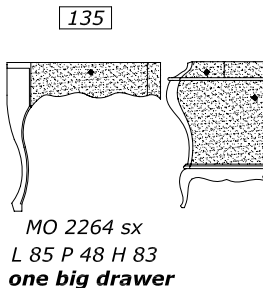
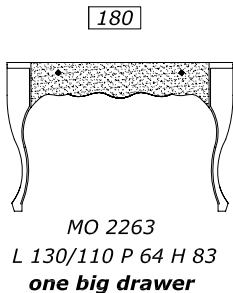

WOOD TOP

CRYSTAL TOP

INCREASE +10% WAVE MANUFACTURE -
 OPTIONAL linear riser h 4 cm linear meter 10 or shaped rider h 10 cm linear meter 15 MAX LENGTH 2,25ml

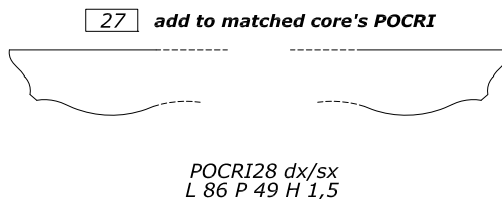
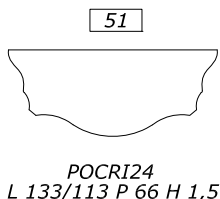
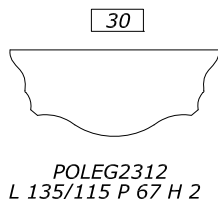

MARBLE TOP

INCREASE +25% THICKNESS CM.3 MAX LENGTH L 2,25 ml

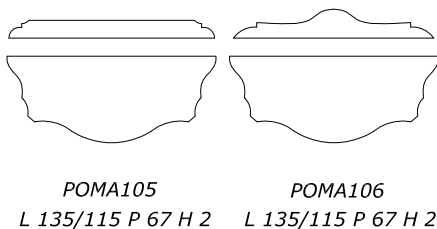

- C1 35
- C2 45
- C3 56
- C4 62
- C5 69

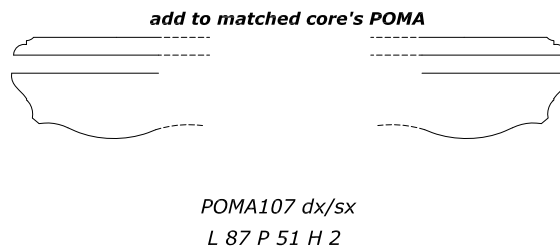

- C1 23
- C2 29
- C3 36
- C4 40
- C5 45

MIRRORS

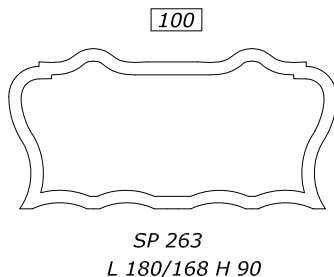

ACCESSORIES

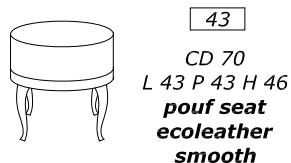
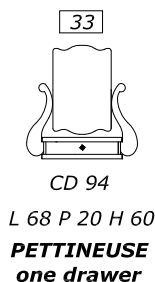

FINISH'S INCREASE CORE AND ACCESSORIES

NERO FUMO ROSSO MODENA NOCE DORATO PATINATO 21 colors	PATINATO 4 metals	BRILLANTE PATINATO NERO FUMO-NOCE DORATO ROSSO MODENA PATINATO 21 colors	BRILLANTE PATINATO 4 metals
PRICE LIST	10%	15%	25%
DECORI core & accessories ROSE-STELLE-LETTERE PATINATO 21 colors	5%	15%	30%
DECORO core & accessories DAMASCO PATINATO 21 colors	10%	20%	35%
DECORI core and accessories ROSE-STELLE-LETTERE PATINATO 4 metals	15%	25%	40%
DECORO core and accessories DAMASCO PATINATO 4 metals	INCREASE MIRRORS without decor		
PRICE LIST	10%	20%	30%

Knob W

IMPORTANT
COMPATIBLE WITH
WASHBASIN OF MAX SIZE
LA 63 - LA 64

ROSE



STELLE

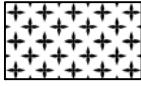

LETTERE



DAMASCATO

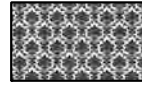

INTERNAL BOTTOM DRAWER - BIG DRAWER AND DOOR 'S COATING
STANDARD LACE AND ECO-LEATHER CORD SAME AS HANDLES **OR/CO/BR**
ON DEMAND CHOOSE COLOR LACE OR ECOLEATHER AND CORD ECOLEATHER **A PRICE LIST**

UNDERTOP WASHBASIN [8] LA 63 WHITE [13] LA 64 BLACK internal 36,5x51,5 external 41x56		OVERTOP WASHBASIN [27] FOGLIA Similgold LA 50 [27] FOGLIA Similsilver LA 51 LA 52 internal 38 external 40	
---	--	---	--

PEREMPTORY WITH MARBLE TOP LA 63 - LA 64
INSTALL SIPHON WITH OVERALL LESS THAN CM. 9

CORE

for one undertop - overtop washbasin

[221]

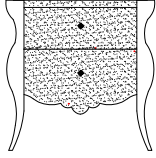

MO 2233
L 90/72 P 58 H 83
two big drawers

[179]

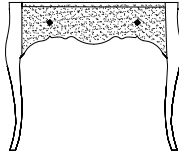

MO 2229
L 115/95 P 58 H 83
one big drawer

[230]

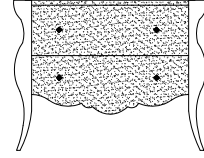

MO 2231
L 115/95 P 58 H 83
two big drawers

CRYSTAL TOP

with washbasin **INCREASE +10% WAVE MANUFACTURE - OPTIONAL** linear riser h 4 cm linear meter [10] or shaped riser h 10 cm linear meter [15]

[57]

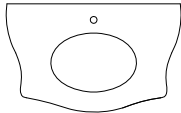

POCRI15
L 89/75 P 58 H 1,5

[74]

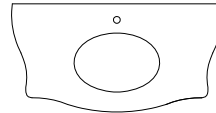

POCRI43
L 113/99 P 58 H 1,5

MARBLE TOP

for one undertop - overtop washbasin **INCREASE +25% THICKNESS CM.3**

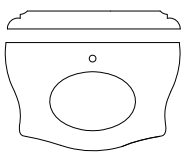

POMA118 undertop
POMA218 overtop
L 91/77 P 59 H 2

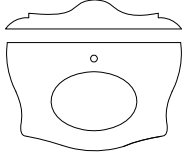

POMA119 undertop
POMA219 overtop
L 91/77 P 59 H 2

- C1 [27]
- C2 [33]
- C3 [41]
- C4 [45]
- C5 [50]

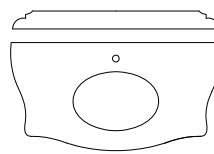

POMA139 undertop
POMA239 overtop
L 116/100 P 59 H 2

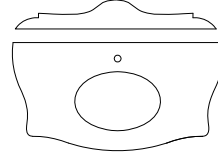

POMA24 undertop
POMA224 overtop
L 116/100 P 59 H 2

- C1 [35]
- C2 [44]
- C3 [53]
- C4 [59]
- C5 [66]

MIRRORS

[46]

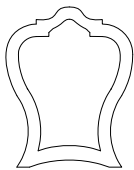

SP 252
L 71/60 H 90

[50]

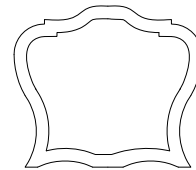

SP 250
L 93/82 H 90

ACCESSORIES

[271]

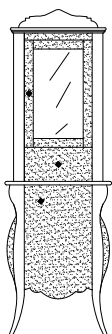

VT 2230 Sx-Dx
L 65/53 P 38 H 180
two doors
one drawers

[359]

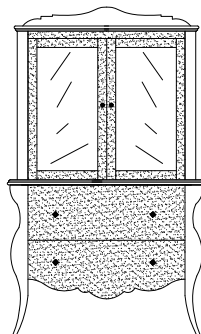

VT 2233
L 106/100 P 41 H 180
two doors
two big drawers

[234]

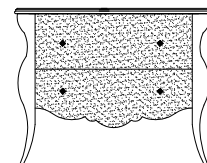

VT 2234
L 106/100 P 41 H 85
two big drawers

[150]

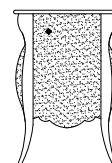

VT 2231 Sx-Dx
L 65/53 P 38 H 85
one door

STANDARD DECORATI

DECOR ON FRONT PART and SIDES **EXCEPT LEG** , CORE'S FRAME and MIRROR
 choose 1) decor 2) decor's color 3) background's color for core and mirror

ON DEMAND DECORATI "TRILOGY"

DECOR ONLY ON THE FRONT PART OF 1°COLOR **EXCEPT SIDES** , LEGS , CORE'S FRAME , MIRROR
 1°COLOR INTERNAL AND EXTERNAL OF DOORS, DRAWERS, BIG DRAWERS AND MIRROR.
 2°COLOR INTERNAL AND EXTERNAL OF FURNITURE STRUCTURE - CABINET.

CHOOSE A) decor and decor's color B) 1° color and 2° color

DECORATI

MY

LINEED WOOD

MAKEUP CORE central

MAKEUP CORE
 match it with cores or
 makeup core central

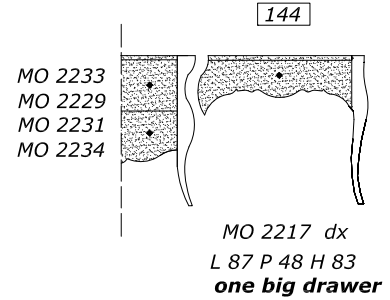
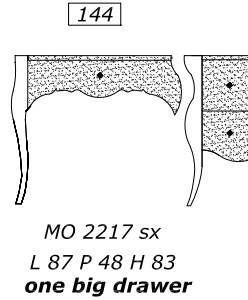
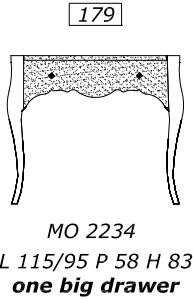

WOOD TOP

CRYSTAL TOP

INCREASE +10% WAVE MANUFACTURE -
 OPTIONAL linear riser h 4 cm linear meter 10 or shaped rider h 10 cm linear meter 15 MAX LENGTH 2,25ml

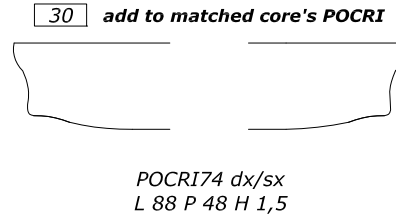
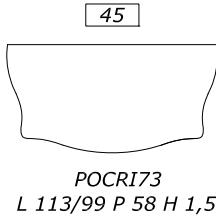
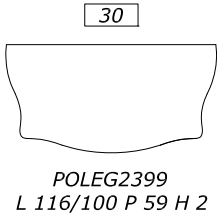

MARBLE TOP

INCREASE +25% THICKNESS CM.3 MAX LENGTH L 2,25 ml

add to matched core's POMA

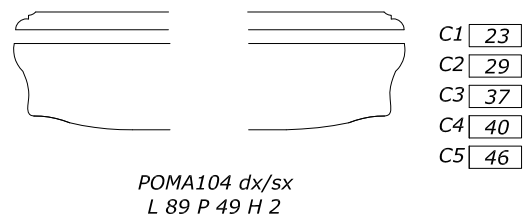
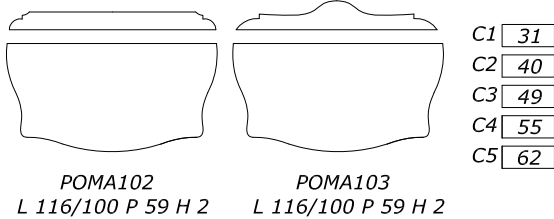

MIRRORS

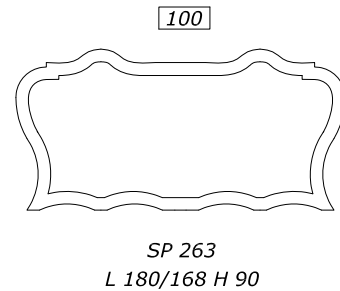
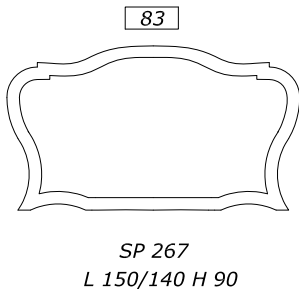

ACCESSORIES

FINISH'S INCREASE CORE AND ACCESSORIES

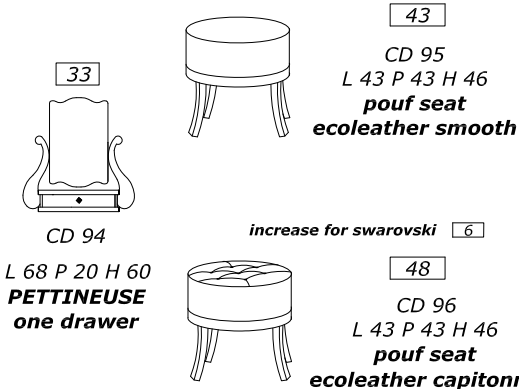

DECORI core & accessories ROSE-STELLE-LETTERE PATINATO 21 colors	PRICE LIST	10%	15%	25%
DECORO core & accessories DAMASCO PATINATO 21 colors	5%	15%	20%	30%
DECORI core and accessories ROSE-STELLE-LETTERE PATINATO 4 metals	10%	20%	25%	35%
DECORO core and accessories DAMASCO PATINATO 4 metals	15%	25%	30%	40%

NERO FUMO ROSSO MODENA NOCE DORATO PATINATO 21 colors	PATINATO 4 metals	BRILLANTE PATINATO NERO FUMO-NOCE DORATO ROSSO MODENA PATINATO 21 colors	BRILLANTE PATINATO 4 metals
PRICE LIST	10%	15%	25%
5%	15%	20%	30%
10%	20%	25%	35%
15%	25%	30%	40%
INCREASE MIRRORS without decor			
PRICE LIST	10%	20%	30%

Knob W

IMPORTANT
COMPATIBLE WITH
WASHBASIN OF MAX SIZE
LA 63 - LA 64

ROSE



STELLE

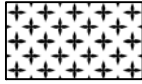

LETTERE



DAMASCATO

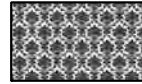

INTERNAL BOTTOM DRAWER - BIG DRAWER AND DOOR 'S COATING
STANDARD LACE AND ECO-LEATHER CORD SAME AS HANDLES **OR/CO/BR**
ON DEMAND CHOOSE COLOR LACE OR ECOLEATHER AND CORD **ECOLEATHER A PRICE LIST**

UNDERTOP WASHBASIN [8] LA 63 WHITE [13] LA 64 BLACK internal 36,5x51,5 external 41x56		OVERTOP WASHBASIN [27] FOGLIA Similgold LA 50 [27] FOGLIA Similsilver LA 51 LA 52 internal 38 external 40	
---	--	---	--

PEREMPATORY WITH MARBLE TOP LA 63 - LA 64
INSTALL SIPHON WITH OVERALL LESS THAN CM. 9

CORE

for one or two undertop - overtop washbasin

[300]

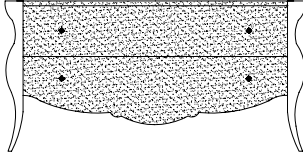

MO 2235
L 173/153 P 58 H 83
two big drawers

[365]

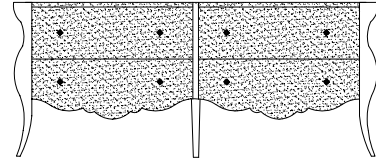

MO 2237
L 203/182 P 58 H 83
four big drawers

CRYSTAL TOP

with washbasin **INCREASE +10% WAVE MANUFACTURE - OPTIONAL** linear riser h 4 cm linear meter [10] or shaped riser h 10 cm linear meter [15]

[92]

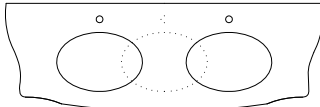

POCRI44 for 1 washbasin
L 172/156 P 58 H 1,5

[123]

POCRI45 for 2 washbasins
L 172/156 P 58 H 1,5

[137]

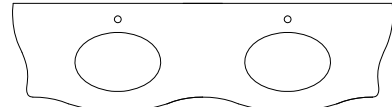

POCRI46
L 200/185 P 58 H 1,5

MARBLE TOP

for one or two undertop - overtop washbasin **INCREASE +25% THICKNESS CM.3**

POMA116 one undertop POMA115 two undertops
POMA216 one overtop POMA215 two overtops
L 173/157 P 59 H 2

- C1 [51]
- C2 [63]
- C3 [79]
- C4 [86]
- C5 [97]

POMA04 one undertop POMA02 two undertops
POMA204 one overtop POMA202 two overtops
L 173/157 P 59 H 2

POMA117 undertop
POMA217 overtop
L 202/186 P 59 H 2

- C1 [62]
- C2 [76]
- C3 [94]
- C4 [103]
- C5 [115]

POMA43 undertop
POMA243 overtop
L 202/186 P 59 H 2

MIRRORS

[83]

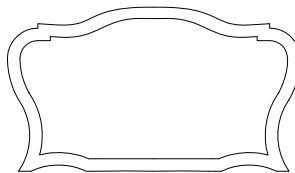

SP 267
L 150/140 H 90

ACCESSORIES

[271]

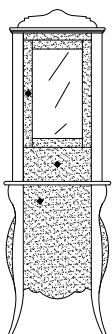

VT 2230 Sx-Dx
L 65/53 P 38 H 180
two doors
one drawers

[359]

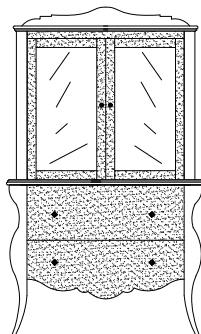

VT 2233
L 106/100 P 41 H 180
two doors
two big drawers

[234]

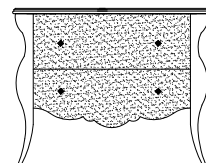

VT 2234
L 106/100 P 41 H 85
two big drawers

[150]

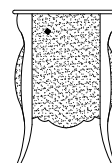

VT 2231 Sx-Dx
L 65/53 P 38 H 85
one door

STANDARD DECORATI

DECOR ON FRONT PART and SIDES **EXCEPT** LEG , CORE'S FRAME and MIRROR
 choose 1) decor 2) decor's color 3) background's color for core and mirror
ON DEMAND DECORATI "TRILOGY"

DECOR ONLY ON THE FRONT PART OF **1°COLOR EXCEPT** SIDES , LEGS , CORE'S FRAME , MIRROR

1°COLOR INTERNAL AND EXTERNAL OF DOORS, DRAWERS, BIG DRAWERS AND MIRROR.
2°COLOR INTERNAL AND EXTERNAL OF FURNITURE STRUCTURE - CABINET.

CHOOSE A) decor and decor's color B) 1° color and 2° color

DECORATI

MY

LINED WOOD

MAKEUP CORE central

MAKEUP CORE
 match it with cores or
 makeup core central

179

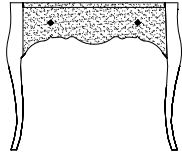

MO 2234
 L 115/95 P 58 H 83
 one big drawer

144

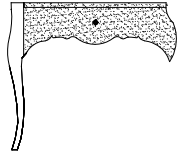

MO 2217 sx
 L 87 P 48 H 83
 one big drawer

144

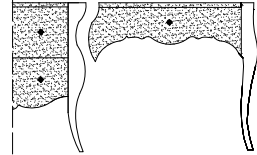

MO 2217 dx
 L 87 P 48 H 83
 one big drawer

MO 2233
 MO 2229
 MO 2231
 MO 2234

WOOD TOP

CRYSTAL TOP

INCREASE +10% WAVE MANUFACTURE -
 OPTIONAL linear riser h 4 cm linear meter 10 or shaped rider h 10 cm linear meter 15 MAX LENGTH 2,25ml

30

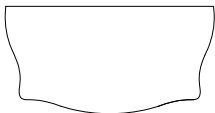

POLEG2399
 L 116/100 P 59 H 2

45

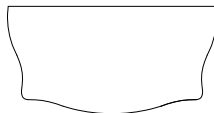

POCRI73
 L 113/99 P 58 H 1,5

30



POCRI74 dx/sx
 L 88 P 48 H 1,5

add to matched core's POCRI

MARBLE TOP

INCREASE +25% THICKNESS CM.3 MAX LENGTH L 2,25 ml

add to matched core's POMA

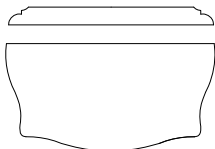

POMA102
 L 116/100 P 59 H 2

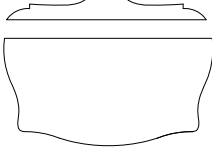

POMA103
 L 116/100 P 59 H 2

- C1 31
- C2 40
- C3 49
- C4 55
- C5 62

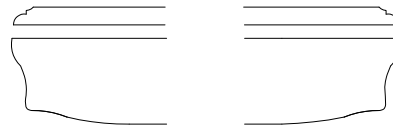

POMA104 dx/sx
 L 89 P 49 H 2

- C1 23
- C2 29
- C3 37
- C4 40
- C5 46

MIRRORS

100

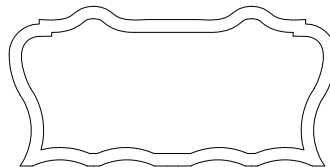

SP 263
 L 180/168 H 90

ACCESSORIES

FINISH'S INCREASE CORE AND ACCESSORIES

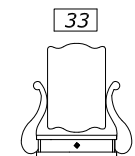

CD 94
 L 68 P 20 H 60
 PETTINEUSE
 one drawer



43
 CD 95
 L 43 P 43 H 46
 pouf seat
 ecoleather smooth



increase for swarovski 6
 48
 CD 96
 L 43 P 43 H 46
 pouf seat
 ecoleather capitonné

DECORI core & accessories ROSE-STELLE-LETTERE PATINATO 21 colors	PRICE LIST	10%	15%	25%
DECORO core & accessories DAMASCO PATINATO 21 colors	5%	15%	20%	30%
DECORI core and accessories ROSE-STELLE-LETTERE PATINATO 4 metals	10%	20%	25%	35%
DECORO core and accessories DAMASCO PATINATO 4 metals	15%	25%	30%	40%

	NERO FUMO ROSSO MODENA NOCE DORATO PATINATO 21 colors	PATINATO 4 metals	BRILLANTE PATINATO NERO FUMO-NOCE DORATO ROSSO MODENA PATINATO 21 colors	BRILLANTE PATINATO 4 metals
PRICE LIST	10%	20%	25%	35%
INCREASE MIRRORS without decor				
PRICE LIST	10%	20%	25%	30%

Knob W

IMPORTANT
COMPATIBLE WITH
WASHBASIN OF MAX SIZE
LA 63 - LA 64 - LA 03

ROSE



STELLE

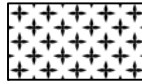

LETTERE



DAMASCATO

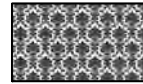

INTERNAL BOTTOM DRAWER - BIG DRAWER AND DOOR 'S COATING
STANDARD LACE AND ECO-LEATHER CORD SAME AS HANDLES **OR/CO/BR**
ON DEMAND CHOOSE COLOR LACE OR ECOLEATHER AND CORD ECOLEATHER **A PRICE LIST**

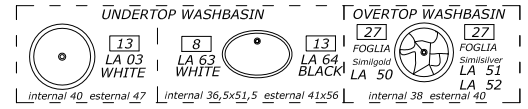

PEREMPORY WITH MARBLE TOP LA 63 - LA 64
INSTALL SIPHON WITH OVERALL LESS THAN CM. 9

CORE

for one or two undertop - overtop washbasin

135

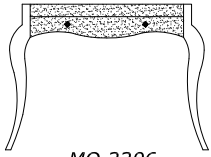

MO 2206
L 106 P 50/37 H 83
one big drawer

150

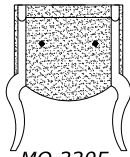

MO 2205
L 63 P 52/37 H 83
one big drawer

150

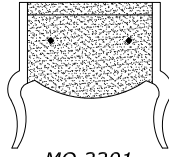

MO 2201
L 84 P 50/37 H 83
one big drawer

160

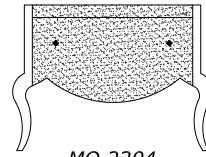

MO 2204
L 104 P 50/37 H 83
one big drawer

340

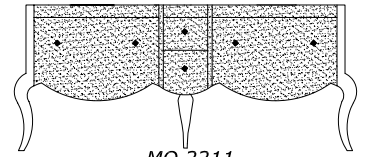

MO 2211
L 190 P 50/37 H 83
two big drawers
two drawers

CERAMIC TOP

except of CORE MO 2206

CRYSTAL TOP

with washbasin INCREASE +10% WAVE MANUFACTURE -
OPTIONAL linear riser h 4 cm linear meter 10 or shaped riser h 10 cm linear meter 15

23

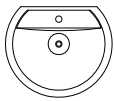

POCER11
L 59 P 52 H 4

29

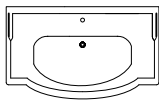

POCER10
L 89 P 55 H 4

34

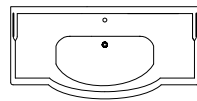

POCER12
L 109 P 55 H 4

53

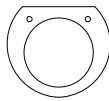

POCRI10
L 62 P 52 H 1,5
only one tap hole Sx - Dx

55

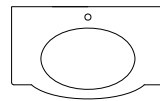

POCRI49
L 82 P 52/39 H 1,5

63

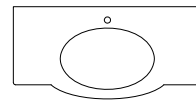

POCRI50
L 102 P 52/39 H 1,5

121

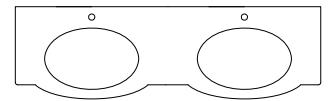

POCRI51
L 187 P 52/39 H 1,5

MARBLE TOP

for one or two undertop - overtop washbasin INCREASE +25% THICKNESS CM.3



POMA170 undertop
POMA270 overtop
only one tap hole Sx - Dx
L 62 P 52 H 2



POMA164 undertop
POMA264 overtop
only one tap hole Sx - Dx
L 85 P 53/40 H 2



POMA165 undertop
POMA265 overtop
only one tap hole Sx - Dx
L 105 P 53/40 H 2



POMA167 undertop
POMA267 overtop
only one tap hole Sx - Dx
L 190 P 53/40 H 2



POMA52 undertop C1 19
POMA252 overtop C2 23
only one tap hole Sx - Dx C3 28
L 62 P 52 H 2 C4 30
C5 34



POMA92 undertop C1 26
POMA292 overtop C2 33
only one tap hole Sx - Dx C3 40
L 85 P 53/40 H 2 C4 44
C5 48



POMA93 undertop C1 32
POMA293 overtop C2 39
only one tap hole Sx - Dx C3 49
L 105 P 53/40 H 2 C4 53
C5 59



POMA97 undertop C1 58
POMA297 overtop C2 73
only one tap hole Sx - Dx C3 89
L 190 P 53/40 H 2 C4 97
C5 107

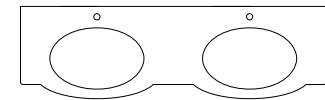
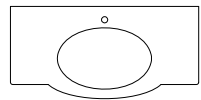
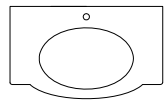
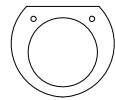

MIRRORS

34

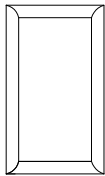

SP 346
L 55 H 95

46

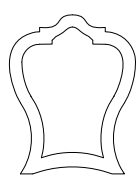

SP 252
L 71/60 H 90

35

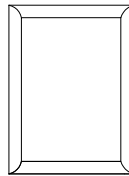

SP 347
L 70 H 95

39

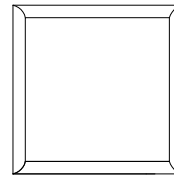

SP 348
L 95 H 95

50

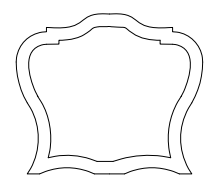

SP 250
L 93/82 H 90

ACCESSORIES

200

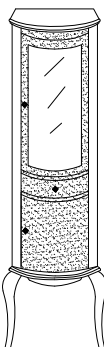

VT 2200 Sx-Dx
L 53 P 41 H 178
two doors
one drawer

350

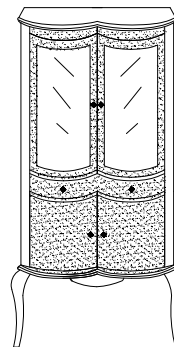

VT 2201
L 94 P 41 H 178
four doors
one drawer

STANDARD DECORATI

DECOR ON FRONT PART and SIDES **EXCEPT** LEG , CORE'S FRAME and MIRROR
 choose 1) decor 2) decor's color 3) background's color for core and mirror
ON DEMAND DECORATI " TRILOGY "

DECOR ONLY ON THE FRONT PART OF 1°COLOR **EXCEPT** SIDES , LEGS , CORE'S FRAME , MIRROR

1°COLOR INTERNAL AND EXTERNAL OF DOORS, DRAWERS, BIG DRAWERS AND MIRROR.
 2°COLOR INTERNAL AND EXTERNAL OF FURNITURE STRUCTURE - CABINET.

CHOOSE A) decor and decor's color B) 1° color and 2° color

DECORATI

MY

LINEDED WOOD

MAKEUP CORE central

MAKEUP CORE

match it with cores or
 makeup core central

135

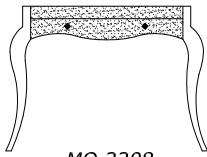

MO 2208
 L 106 P 50/37 H 83
 one big drawer

98

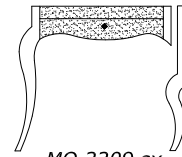

MO 2209 sx
 L 74 P 34/31 H 83
 one big drawer

98

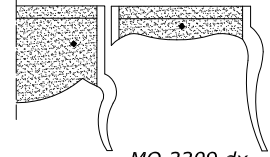

MO 2209 dx
 L 74 P 34/31 H 83
 one big drawer

MO 2206
 MO 2205
 MO 2201
 MO 2204
 MO 2211
 MO 2208

WOOD TOP

CRYSTAL TOP

INCREASE +10% WAVE MANUFACTURE -

OPTIONAL linear riser h 4 cm linear meter 10 or shaped rider h 10 cm linear meter 15 MAX LENGTH 2,25ml

30



POLEG2329
 L 105 P 53/40 H 2

34



POCRI63
 L 102 P 52/39 H 1,5

14



POCRI164 dx/sx
 L 73 P 36 H 1,5

add to matched core's POCRI

MARBLE TOP

INCREASE +25% THICKNESS CM.3 MAX LENGTH L 2,25 ml

add to matched core's POMA

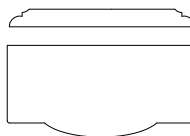

POMA143
 L 105 P 53/40 H 2

- C1 28
- C2 35
- C3 45
- C4 49
- C5 55



POMA144 dx/sx
 L 74 P 36 H 2

- C1 19
- C2 24
- C3 31
- C4 34
- C5 38

MIRRORS

44

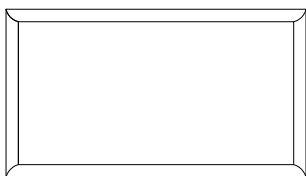

SP 349
 L 170 H 95

83

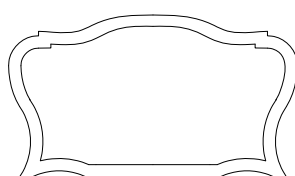

SP 267
 L 150/140 H 90

47

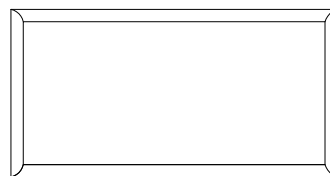

SP 345
 L 185 H 95

100

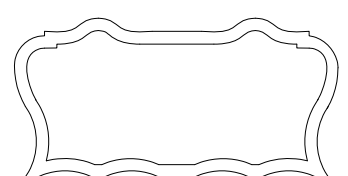

SP 263
 L 180/168 H 90

ACCESSORIES

FINISH'S INCREASE CORE AND ACCESSORIES

43
 CD 72
 L 43 P 43 H 46
 pouf seat
 ecoleather smooth

33
 CD 94
 L 68 P 20 H 60
 PETTINEUSE
 one drawer

increase for swarovski 6

48
 CD 73
 L 43 P 43 H 46
 pouf seat
 ecoleather capitonné

DECORI core & accessories ROSE-STELLE-LETTERE PATINATO 21 colors	PRICE LIST	10%	15%	25%
DECORO core & accessories DAMASCO PATINATO 21 colors	5%	15%	20%	30%
DECORI core and accessories ROSE-STELLE-LETTERE PATINATO 4 metals	10%	20%	25%	35%
DECORO core and accessories DAMASCO PATINATO 4 metals	15%	25%	30%	40%

	NERO FUMO ROSSO MODENA NOCE DORATO PATINATO 21 colors	PATINATO 4 metals	BRILLANTE PATINATO NERO FUMO-NOCE DORATO ROSSO MODENA PATINATO 21 colors	BRILLANTE PATINATO 4 metals
PRICE LIST		10%	15%	25%
	5%	15%	20%	30%
	10%	20%	25%	35%
	15%	25%	30%	40%
INCREASE MIRRORS without decor				
PRICE LIST		10%	20%	30%

Knob W

IMPORTANT
COMPATIBLE WITH
WASHBASIN OF MAX SIZE
LA 63 - LA 64

ROSE



STELLE

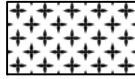

LETTERE



DAMASCATO

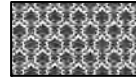

INTERNAL BOTTOM DRAWER - BIG DRAWER AND DOOR 'S COATING
STANDARD LACE AND ECO-LEATHER CORD SAME AS HANDLES **OR/CO/BR**
ON DEMAND CHOOSE COLOR LACE OR ECOLEATHER AND CORD ECOLEATHER **A PRICE LIST**

UNDERTOP WASHBASIN		OVERTOP WASHBASIN	
8 LA 63 WHITE		13 LA 64 BLACK	
internal 36,5x51,5 external 41x56		internal 38 external 40	

PEREMPTORY WITH MARBLE TOP LA 63 - LA 64
 INSTALL SIPHON WITH OVERALL LESS THAN CM. 9

CORE

for one or two undertop - overtop washbasin

135

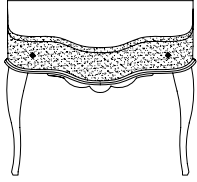

MO 2279
L 106 P 58/41 H 82
one big drawer

202

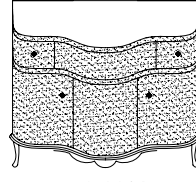

MO 2280
L 106 P 58/41 H 82
**three doors
two drawers**

190

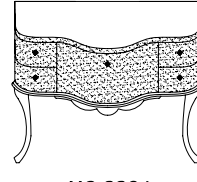

MO 2284
L 106 P 58/41 H 82
**one big drawer
four drawers**

232

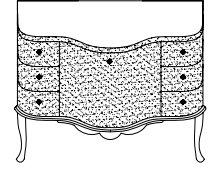

MO 2281
L 106 P 58/41 H 82
**one big drawer
six drawers**

373

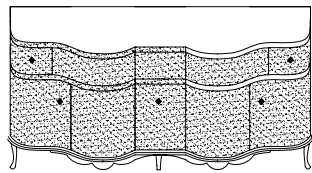

MO 2282
L 174 P 58/41 H 82
**four doors
one basket
two drawers**

390

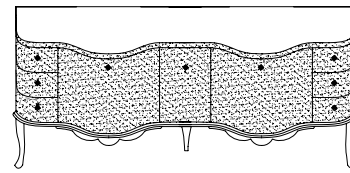

MO 2283
L 192 P 58/41 H 82
**two big drawers
one basket
two drawers**

CERAMIC TOP

except of CORE MO 2279

54

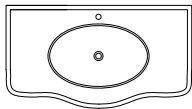

POCER59
L 110 P 61 H 4

71

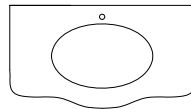

POCRI60
L 105 P 59/42 H 1,5

123

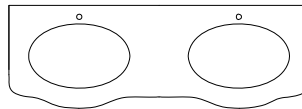

POCRI61
L 173 P 59/42 H 1,5

129

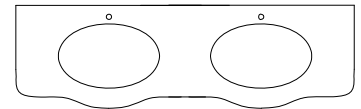

POCRI62
L 189 P 59/41 H 1,5

CRYSTAL TOP

with washbasin **INCREASE +10% WAVE MANUFACTURE -**
OPTIONAL linear riser h 4 cm linear meter 10 or shaped riser h 10 cm linear meter 15

MARBLE TOP

for one undertop - overtop washbasin **INCREASE +25% THICKNESS CM.3**

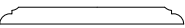

POMA109 undertop
POMA209 overtop
L 107 P 60/43 H 2

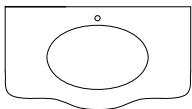

C1	33	C1	54
C2	41	C2	67
C3	51	C3	82
C4	56	C4	89
C5	62	C5	100

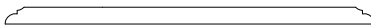

POMA100 undertop
POMA200 overtop
L 175 P 60/43 H 2

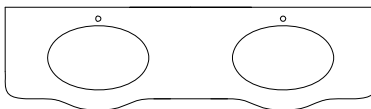

C1	58
C2	72
C3	88
C4	96
C5	108



POMA59 undertop
POMA259 overtop
L 107 P 60/43 H 2

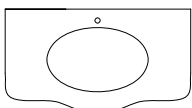

C1	33	C1	54
C2	41	C2	67
C3	51	C3	82
C4	56	C4	89
C5	62	C5	100

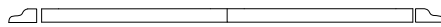

POMA98 undertop
POMA298 overtop
L 175 P 60/43 H 2

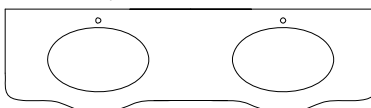

C1	58
C2	72
C3	88
C4	96
C5	108

MIRRORS

35

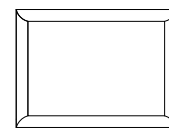

SP 347
L 95 H 70

39

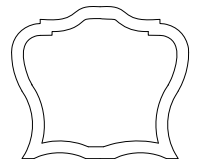

SP 348
L 95 H 95

50

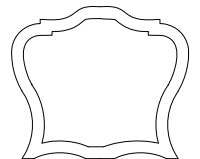

SP 250
L 93/82 H 90

ACCESSORIES

200

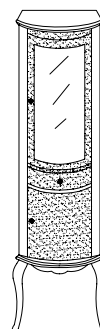

VT 2280 Sx-Dx
L 53 P 41 H 178

**two doors
one drawer**

350

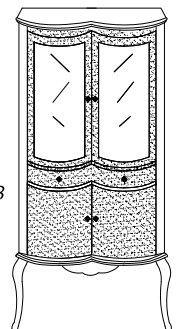

VT 2281
L 94 P 41 H 178

**four doors
one drawer**

STANDARD DECORATI

DECOR ON FRONT PART and SIDES **EXCEPT** LEG , CORE'S FRAME and MIRROR
 choose 1) decor 2) decor's color 3) background's color for core and mirror
ON DEMAND DECORATI " TRILOGY "

DECOR ONLY ON THE FRONT PART OF 1°COLOR **EXCEPT** SIDES , LEGS , CORE'S FRAME , MIRROR

1°COLOR INTERNAL AND EXTERNAL OF DOORS, DRAWERS, BIG DRAWERS UPPER CORE AND MIRROR.
 2°COLOR INTERNAL AND EXTERNAL OF FURNITURE STRUCTURE - CABINET.

CHOOSE A) decor and decor's color B) 1° color and 2° color

DECORATI

MY

LINEED WOOD

MAKEUP CORE central

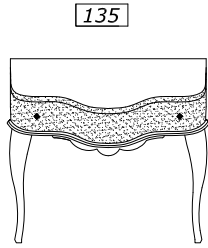

MO 2288
 L 106 P 58/41 H 82
one big drawer

MAKEUP CORE

match it with cores or
 makeup core central

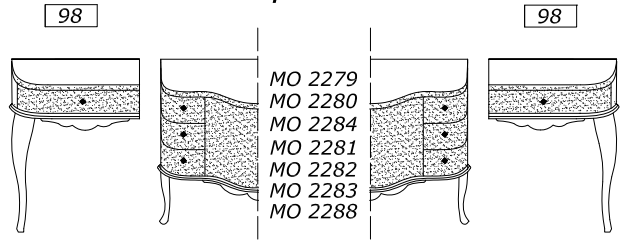

MO 2289 sx
 L 76 P 35 H 83
one big drawer

MO 2289 dx
 L 76 P 35 H 83
one big drawer

WOOD TOP

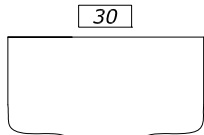

POLEG2315
 L 107 P 60/43 H 2

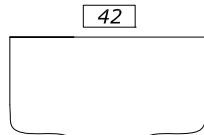

POCRI65
 L 106 P 59/42 H 1,5

CRYSTAL TOP

INCREASE +10% WAVE MANUFACTURE -
 OPTIONAL linear riser h 4 cm linear meter 10 or shaped rider h 10 cm linear meter 15 MAX LENGTH 2,25ml

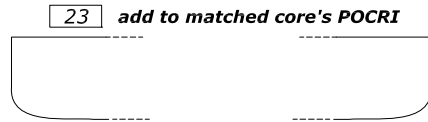

POCRI66 dx/sx
 L 77 P 37 H 1,5

MARBLE TOP

INCREASE +25% THICKNESS CM.3 MAX LENGTH L 2,25 ml

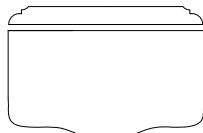

POMA108
 L 107 P 60/43 H 2

- C1 29
- C2 37
- C3 47
- C4 52
- C5 58



POMA113 dx/sx
 L 77 P 37 H 2

- C1 20
- C2 25
- C3 32
- C4 35
- C5 40

MIRRORS

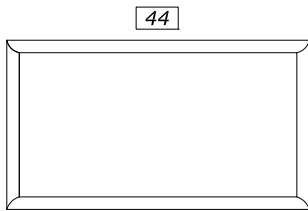

SP 349
 L 170 H 95

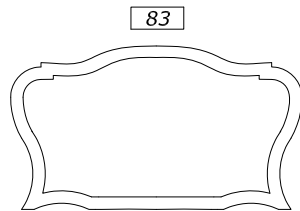

SP 267
 L 150 H 90

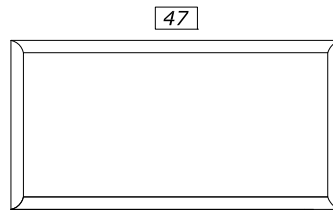

SP 345
 L 185 H 95

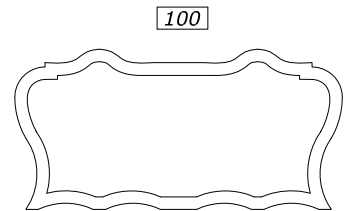

SP 263
 L 180 H 90

ACCESSORIES

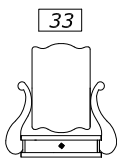

CD 94
 L 68 P 20 H 60
PETTINEUSE
one drawer



CD 72
 L 43 P 43 H 46
pouf seat
ecoleather smooth



CD 73
 L 43 P 43 H 46
pouf seat
ecoleather capitonné

increase for swarovski 6

FINISH'S INCREASE CORE AND ACCESSORIES

NERO FUMO ROSSO MODENA NOCE DORATO PATINATO 21 colors	PATINATO 4 metals	BRILLANTE PATINATO NERO FUMO-NOCE DORATO ROSSO MODENA PATINATO 21 colors	BRILLANTE PATINATO 4 metals	
DECORI core & accessories ROSE-STELLE-LETTERE PATINATO 21 colors	PRICE LIST	10%	15%	25%
DECORO core & accessories DAMASCO PATINATO 21 colors	5%	15%	20%	30%
DECORI core & accessories ROSE-STELLE-LETTERE PATINATO 4 metals	10%	20%	25%	35%
DECORO core & accessories DAMASCO PATINATO 4 metals	15%	25%	30%	40%
INCREASE MIRRORS without decor				
PRICE LIST	10%	20%	30%	

MOBILI

Knob - handle B

PEREMPORY 1°COLOR INTERNAL AND EXTERNAL OF DOORS, DRAWERS, BIG DRAWERS AND MIRROR
BICOLORE 2°COLOR INTERNAL AND EXTERNAL OF FURNITURE STRUCTURE, CABINET

ON DEMAND BICOLOR WITH THE SAME FINISH
 PRICE LIST WITH INCREASE FOR THE CHOICE FINISH
ON DEMAND BICOLOR WITH TWO DIFFERENT FINISHES
 PRICE LIST WITH INCREASE CALCULATED ON THE HIGHER INCREASE CHOOSEN FINISH

UNDERTOP WASHBASIN 8 LA 63 WHITE 13 LA 64 BLACK <small>internal 36,5x51,5 external 41x56</small>		OVERTOP WASHBASIN 27 FOGLIA Similgold LA 50 27 FOGLIA Similsilver LA 51 LA 52 <small>internal 38 external 40</small>	
--	--	--	--

PEREMPORY WITH MARBLE TOP LA 63 - LA 64
 INSTALL SIPHON WITH OVERALL LESS THAN CM. 9

CORE

for one or two undertop - overtop washbasin

130	200	269	243	363	335
MO 2585 L 130/110 P 64 H 83 one big drawer	MO 2541 L 132/119 P 56 H 83 one big drawer	MO 2540 L 132/119 P 56 H 83 one big drawer four drawers	MO 2539 L 132/119 P 56 H 83 two big drawers	MO 2267 one washbasin L 185/172 P 63 H 83 one big drawer four drawers	MO 2268 two washbasins L 185/172 P 63 H 83 one big drawer two drawers

CRYSTAL TOP

with washbasin INCREASE +10% WAVE MANUFACTURE - OPTIONAL linear riser h 4 cm linear meter 10 or shaped riser h 10 cm linear meter 15

80	76	97	123
POCRI93 L 133/113 P 66 H 1,5	POCRI90 L 121/89 P 57 H 1,5	POCRI91 L 174/146 P 65 H 1,5	POCRI92 L 174/146 P 65 H 1,5

MARBLE TOP

for one or two undertop - overtop washbasin INCREASE +25% THICKNESS CM.3

POMA175 undertop POMA275 overtop L 135/115 P 67 H 2 C1 39 C2 48 C3 59 C4 65 C5 73	POMA160 undertop POMA260 overtop L 123/91 P 58 H 2 C1 35 C2 44 C3 54 C4 59 C5 66	POMA161 for 1 undertop POMA261 for 1 overtop POMA162 for 2 undertop POMA262 for 2 overtop L 177/148 P 65 H 2	POMA184 for 1 undertop POMA284 for 1 overtop POMA186 for 2 undertop POMA286 for 2 overtop L 177/148 P 65 H 2	C1 52 C2 64 C3 79 C4 87 C5 97
--	---	--	--	---

MIRRORS

50	83
SP 250 L 93/82 H 90	SP 267 L 150/140 H 90

ACCESSORIES

198 VT 2540 Sx-Dx L 70/65 P 38 H 180 one door one drawer one big drawer	370 VT 2542 L 132/119 P 38 H 180 two doors two big drawers	245 VT 2543 L 132/119 P 38 H 85 two big drawers	115 VT 2541 L 70/53 P 38 H 85 one big drawer
---	--	---	--

INTERNAL BOTTOM DRAWER - BIG DRAWER AND DOOR 'S COATING
STANDARD LACE AND ECO-LEATHER CORD SAME AS HANDLES **OR/CO/BR**
ON DEMAND CHOOSE COLOR LACE OR ECOLEATHER AND CORD ECOLEATHER **A PRICE LIST**

LINDEN WOOD

MAKEUP CORE central

MAKEUP CORE
 match it with cores or
 makeup core central

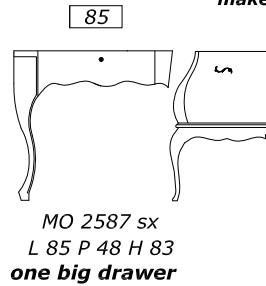
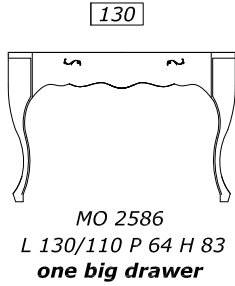

- MO 2585
- MO 2541
- MO 2540
- MO 2539
- MO 2542
- MO 2543
- MO 2586

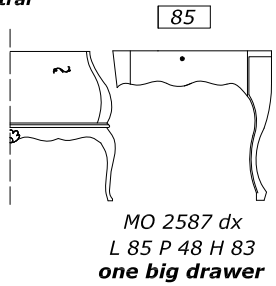

WOOD TOP

CRYSTAL TOP

increase +10% WAVE MANUFACTURE -
 OPTIONAL linear riser h4 cm l.m. 10 or raised shaped h 10 cm l.m. 15 MAX LENGTH 2,25ml

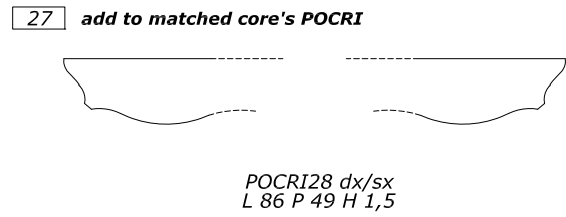
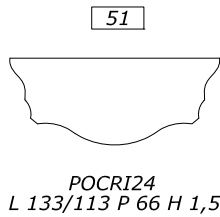
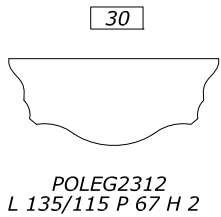

MARBLE TOP

INCREASE +25% THICKNESS CM.3 MAX LENGTH L 2,25 ml

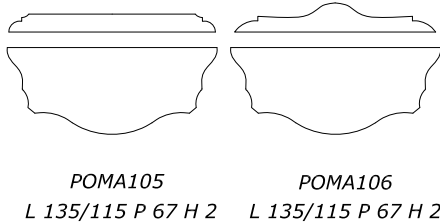

- C1 35
- C2 45
- C3 56
- C4 62
- C5 69

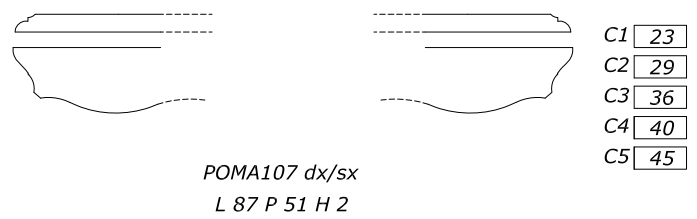

- C1 23
- C2 29
- C3 36
- C4 40
- C5 45

MIRRORS

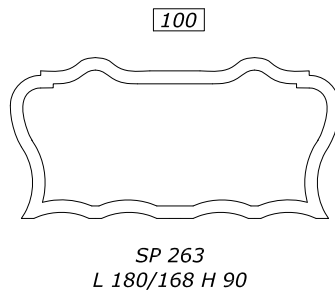

ACCESSORIES

FINISH'S INCREASE
ONECOLOR-BICOLOR

NERO F.-ROSSO M.-NOCE D.	PRICE LIST
ANTICATO 21 colors	PRICE LIST
PATINATO 21 colors	PRICE LIST
ANTICATO 4 metals	10%
PATINATO 4 metals	10%
LACCATO 21 colors	10%
BRILLANTE 21 colors	20%
MADREPERLA 21 colors	20%
FOGLIA oro/argento	10%
FOGLIA PATINATA oro/arg	10%

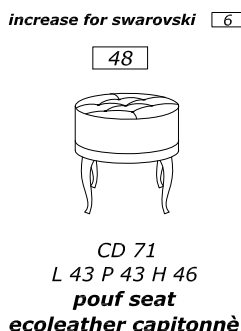
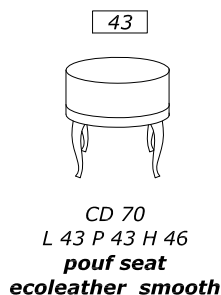
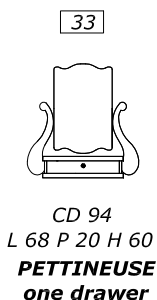

Knob - handle B

IMPORTANT
COMPATIBLE WITH
WASHBASIN OF MAX SIZE
LA 63 - LA 64

PEREMPTORY 1°COLOR INTERNAL AND EXTERNAL OF DOORS , DRAWERS , BIG DRAWERS UPPER CORE AND MIRROR.
BICOLOR 2°COLOR INTERNAL AND EXTERNAL OF FURNITURE STRUCTURE - CABINET.

ON DEMAND BICOLOR WITH THE SAME FINISH

PRICE LIST WITH INCREASE FOR THE CHOICE FINISH

ON DEMAND BICOLOR WITH TWO DIFFERENT FINISHES

PRICE LIST WITH INCREASE CALCULATED ON THE HIGHER INCREASE CHOSEN FINISH

UNDERTOP WASHBASIN		OVERTOP WASHBASIN	
8		13	
LA 63	WHITE	LA 64	BLACK
internal 36,5x51,5 external 41x56		internal 38 external 40	
27		27	
FOGLIA	Similgold	FOGLIA	Similsilver
LA 50		LA 51	
		LA 52	

PEREMPTORY WITH MARBLE TOP LA 63 - LA 64

INSTALL SIPHON WITH OVERALL LESS THAN CM. 9

CORE

for one or two undertop - overtop washbasin

130

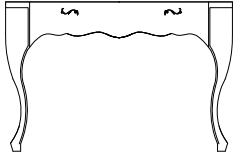

MO 2585
L 130/110 P 64 H 83
one big drawer

218

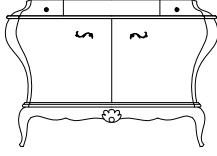

MO 250
L 132/110 P 60 H 82
two doors
two drawers

261

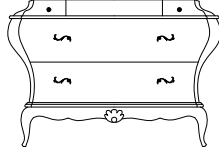

MO 252
L 132/110 P 60 H 82
two big drawers
two drawers

297

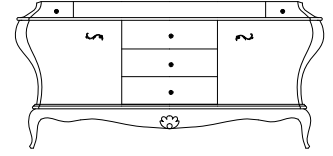

MO 251
L 176/152 P 60 H 82
two doors
three drawers

CRYSTAL TOP

with washbasin INCREASE +10% WAVE MANUFACTURE - OPTIONAL linear riser h 4 cm linear meter 10 or shaped riser h 10 cm linear meter 15

80

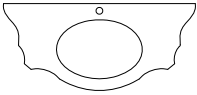

POCRI93
L 133/115 P 66 H 1,5

76

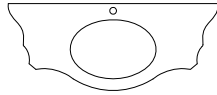

POCRI40
L 123/104 P 59 H 1,5

92

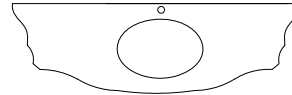

POCRI41
L 166/148 P 59 H 1,5

123

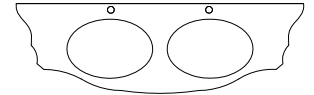

POCRI42
L 166/148 P 59 H 1,5

MARBLE TOP

for one or two undertop - overtop washbasin INCREASE +25% THICKNESS CM.3

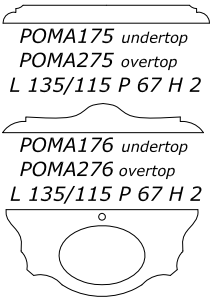

POMA175 undertop
POMA275 overtop
L 135/115 P 67 H 2

- C1 39
- C2 48
- C3 59
- C4 65
- C5 73

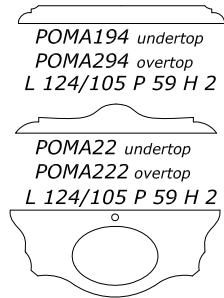

POMA194 undertop
POMA294 overtop
L 124/105 P 59 H 2

- C1 36
- C2 45
- C3 56
- C4 61
- C5 68

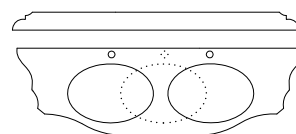

POMA195 for 1 undertop
POMA295 for 1 overtop
POMA196 for 2 undertops
POMA296 for 2 overtops
L 167/149 P 59 H 2

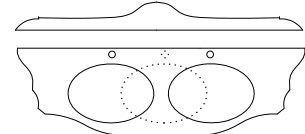

POMA12 for 1 undertop
POMA212 for 1 overtop
POMA63 for 2 undertops
POMA263 for 2 overtops
L 167/149 P 59 H 2

- C1 50
- C2 62
- C3 76
- C4 83
- C5 93

MIRRORS

50

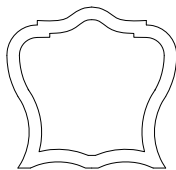

SP 250
L 93/82 H 90

83

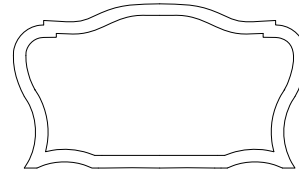

SP 267
L 150/140 H 90

ACCESSORIES

198

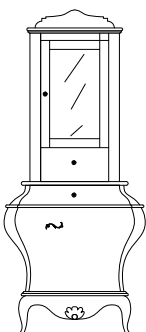

VT 250 Sx-Dx
L 71/53 P 38 H 180
two doors
two drawers

388

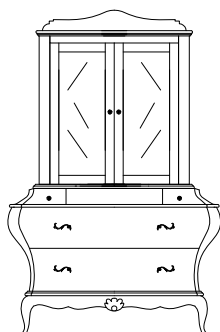

VT 253
L 132/110 P 38 H 180
two doors
two drawers
two big drawers

263

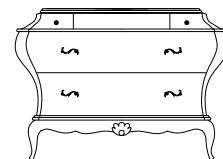

VT 254
L 132/110 P 38 H 85
two big drawers
two drawers

115

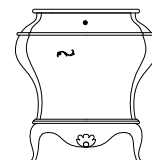

VT 251 Sx-Dx
L 71/53 P 38 H 85
one door
one drawer

INTERNAL BOTTOM DRAWER - BIG DRAWER AND DOOR 'S COATING
STANDARD LACE AND ECO-LEATHER CORD SAME AS HANDLES **OR/CO/BR**
ON DEMAND CHOOSE COLOR LACE OR ECOLEATHER AND CORD ECOLEATHER **A PRICE LIST**

LINDEN WOOD

MAKEUP CORE central

MAKEUP CORE
 match it with cores or
 makeup core central

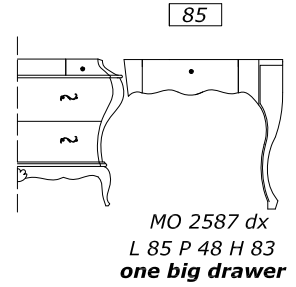
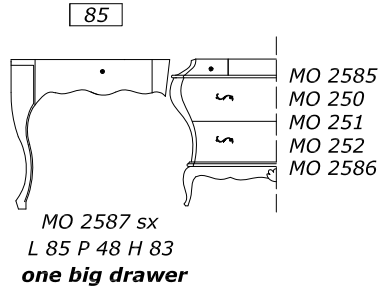
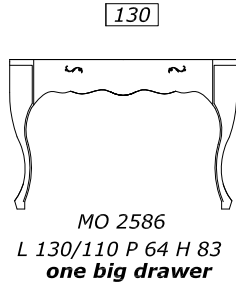

WOOD TOP

CRYSTAL TOP

INCREASE +10% WAVE MANUFACTURE -
 OPTIONAL linear riser h 4 cm linear meter 10 or shaped rider h 10 cm linear meter 15 MAX LENGTH 2,25ml

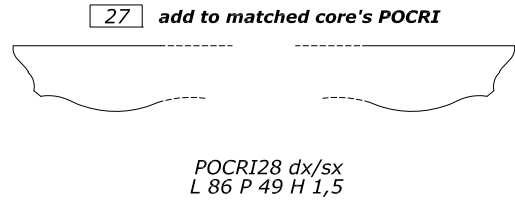
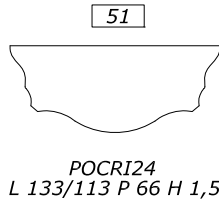
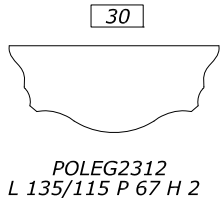

MARBLE TOP

INCREASE +25% THICKNESS CM.3 MAX LENGTH L 2,25 ml

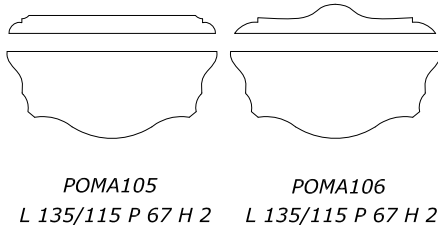

- C1 35
- C2 45
- C3 56
- C4 62
- C5 69

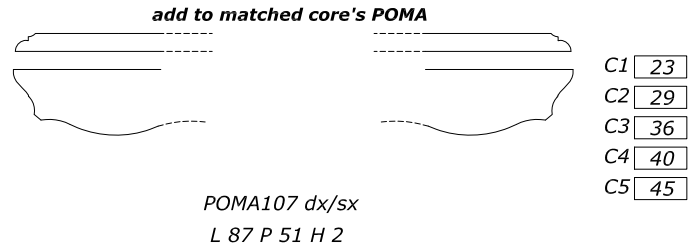

MIRRORS

100

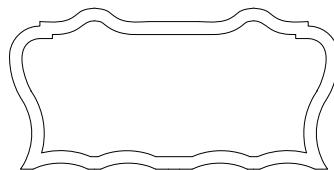

SP 263
 L 180/168 H 90

ACCESSORIES

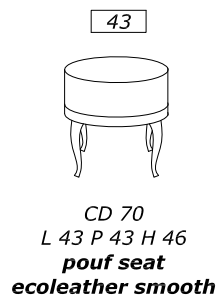
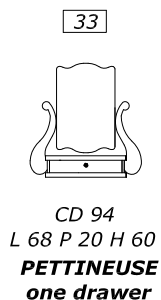

increase for swarovski 6

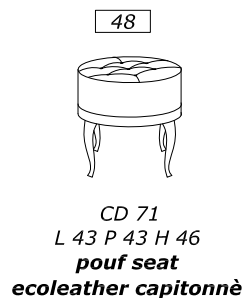

FINISH'S INCREASE
ONECOLOR-BICOLOR

NERO F.-ROSSO M.-NOCE D.	PRICE LIST
ANTICATO 21 colors	PRICE LIST
PATINATO 21 colors	PRICE LIST
ANTICATO 4 metals	10%
PATINATO 4 metals	10%
LACCATO 21 colors	10%
BRILLANTE 21 colors	20%
MADREPERLA 21 colors	20%
FOGLIA oro/argento	10%
FOGLIA PATINATA oro/arg	10%

Knob - handle D

IMPORTANT
COMPATIBLE WITH
WASHBASIN OF MAX SIZE
LA 63 - LA 64

PEREMPTORY 1°COLOR INTERNAL AND EXTERNAL OF DOORS , DRAWERS , BIG DRAWERS AND MIRROR
BICOLORE 2°COLOR INTERNAL AND EXTERNAL OF FURNITURE STRUCTURE , CABINET
ON DEMAND BICOLOR WITH THE SAME FINISH
PRICE LIST WITH INCREASE FOR THE CHOICE FINISH
ON DEMAND BICOLOR WITH TWO DIFFERENT FINISHES
PRICE LIST WITH INCREASE CALCULATED ON THE HIGHER INCREASE CHOSEN FINISH

UNDERTOP WASHBASIN [8] LA 63 WHITE internal 36,5x51,5		OVERTOP WASHBASIN [13] LA 64 BLACK internal 41x56		[27] FOGLIA Similgold LA 50 internal 38		[27] FOGLIA Similsilver LA 51 LA 52 external 40	
--	--	--	--	---	--	--	--

PEREMPTORY WITH MARBLE TOP LA 63 - LA 64
INSTALL SIPHON WITH OVERALL LESS THAN CM. 9

CORE

for one undertop - overtop washbasin

[162]

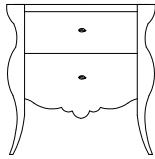

MO 276
L 90/72 P 58 H 83
two big drawers

[115]

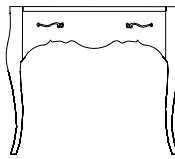

MO 277
L 115/95 P 58 H 83
one big drawer

[171]

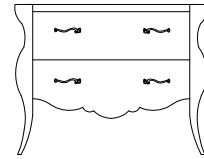

MO 261
L 115/95 P 58 H 83
two drawers

CRYSTAL TOP

with washbasin INCREASE +10% WAVE MANUFACTURE - OPTIONAL linear riser h 4 cm linear meter [10] or shaped riser h 10 cm linear meter [15]

[57]

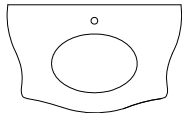

POCRI15
L 89/75 P 58 H 1,5

[74]

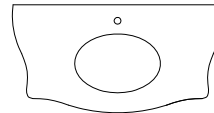

POCRI43
L 113/99 P 58 H 1,5

MARBLE TOP

for one undertop - overtop washbasin INCREASE +25% THICKNESS CM.3

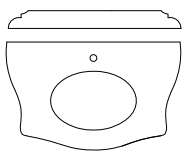

POMA118 undertop
POMA218 overtop
L 91/77 P 59 H 2

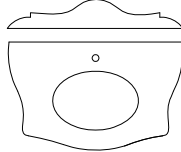

POMA119 undertop
POMA219 overtop
L 91/77 P 59 H 2

- C1 [27]
- C2 [33]
- C3 [41]
- C4 [45]
- C5 [50]

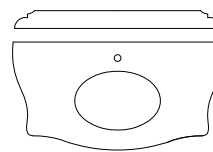

POMA139 undertop
POMA239 overtop
L 116/100 P 59 H 2

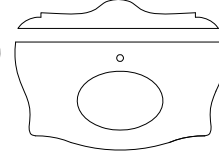

POMA24 undertop
POMA224 overtop
L 116/100 P 59 H 2

- C1 [35]
- C2 [44]
- C3 [53]
- C4 [59]
- C5 [66]

MIRRORS

[46]

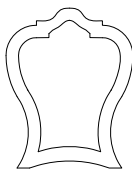

SP 252
L 71/60 H 90

[50]

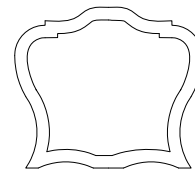

SP 250
L 93/82 H 90

ACCESSORIES

[183]

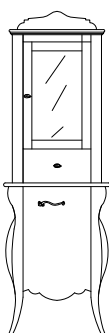

VT 260 Sx-Dx
L 65/53 P 38 H 180
**two doors
one drawer**

[300]

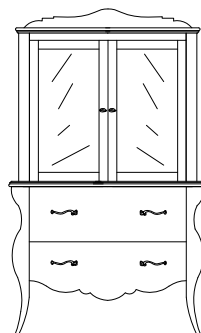

VT 263
L 106/100 P 41 H 180
**two doors
two big drawers**

[175]

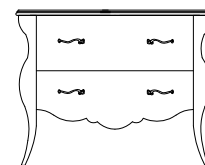

VT 264
L 106/100 P 41 H 85
two big drawers

[100]

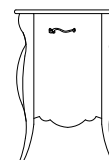

VT 261 Sx-Dx
L 65/53 P 38 H 85
one door

INTERNAL BOTTOM DRAWER - BIG DRAWER AND DOOR 'S COATING
STANDARD LACE AND ECO-LEATHER CORD SAME AS HANDLES **OR/CO/BR**
ON DEMAND CHOOSE COLOR LACE OR ECOLEATHER AND CORD ECOLEATHER **A PRICE LIST**

LINDEN WOOD

MAKEUP CORE central

MAKEUP CORE

match it with cores or
makeup core central

115

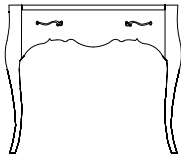

MO 278
L 115/95 P 58 H 83
one big drawer

80

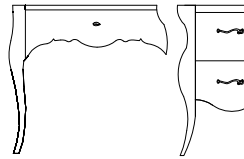

MO 219 sx
L 87 P 48 H 83
one big drawer

80

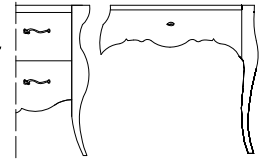

MO 219 dx
L 87 P 48 H 83
one big drawer

MO 276
MO 277
MO 261
MO 278

WOOD TOP

CRYSTAL TOP

INCREASE +10% WAVE MANUFACTURE -
 OPTIONAL linear riser h 4 cm linear meter 10 or shaped rider h 10 cm linear meter 15 MAX LENGTH 2,25ml

30

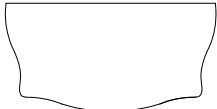

POLEG2399
L 116/100 P 59 H 2

45



POCRI73
L 113/99 P 58 H 1,5

30

add to matched core's POCRI



POCRI74 dx/sx
L 88 P 48 H 1,5

MARBLE TOP

INCREASE +25% THICKNESS CM.3 MAX LENGTH L 2,25 ml

add to matched core's POMA

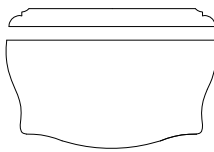

POMA102
L 116/100 P 59 H 2

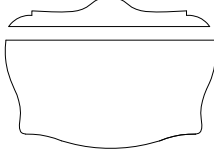

POMA103
L 116/100 P 59 H 2

- C1 31
- C2 40
- C3 49
- C4 55
- C5 62

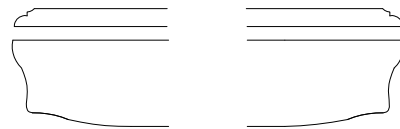

POMA104 dx/sx
L 89 P 49 H 2

- C1 23
- C2 29
- C3 37
- C4 40
- C5 46

MIRRORS

83

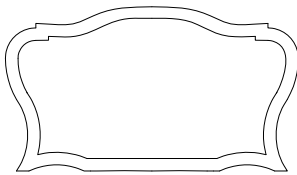

SP 267
L 150/140 H 90

100

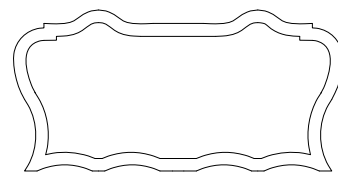

SP 263
L 180/168 H 90

ACCESSORIES

increase for swarovski 6

33

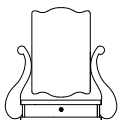

CD 94
L 68 P 20 H 60
PETTINEUSE
one drawer

43



CD 95
L 43 P 43 H 46
pouf seat
ecoleather smooth

48



CD 96
L 43 P 43 H 46
pouf seat
ecoleather capitonné

FINISH'S INCREASE
ONECOLOR-BICOLOR



NERO F.-ROSSO M.-NOCE D.	PRICE LIST
ANTICATO 21 colors	PRICE LIST
PATINATO 21 colors	PRICE LIST
ANTICATO 4 metals	10%
PATINATO 4 metals	10%
LACCATO 21 colors	10%
BRILLANTE 21 colors	15%
MADREPERLA 21 colors	15%
FOGLIA oro/argento	15%
FOGLIA PATINATA oro/arg	15%

Knob - handle D

IMPORTANT
COMPATIBLE WITH
WASHBASIN OF MAX SIZE
LA 63 - LA 64

PEREMPTORY 1°COLOR INTERNAL AND EXTERNAL OF DOORS , DRAWERS , BIG DRAWERS AND MIRROR
BICOLORE 2°COLOR INTERNAL AND EXTERNAL OF FURNITURE STRUCTURE , CABINET

ON DEMAND BICOLOR WITH THE SAME FINISH
PRICE LIST WITH INCREASE FOR THE CHOICE FINISH
ON DEMAND BICOLOR WITH TWO DIFFERENT FINISHES
PRICE LIST WITH INCREASE CALCULATED ON THE HIGHER INCREASE CHOSEN FINISH

UNDERTOP WASHBASIN		OVERTOP WASHBASIN	
8 LA 63 WHITE		13 LA 64 BLACK	
internal 36,5x51,5 external 41x56		internal 38 external 40	

PEREMPTORY WITH MARBLE TOP LA 63 - LA 64

INSTALL SIPHON WITH OVERALL LESS THAN CM. 9

CORE
for one or two undertop - overtop washbasin

230

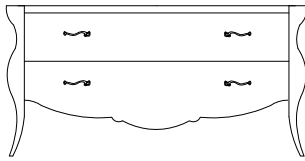

MO 266
L 173/153 P 58 H 83
two big drawers

281

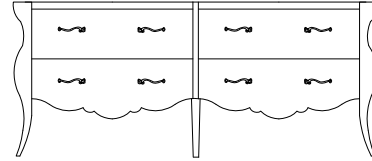

MO 263
L 203/182 P 58 H 83
four big drawers

CRYSTAL TOP

with washbasin INCREASE +10% WAVE MANUFACTURE - OPTIONAL linear riser h 4 cm linear meter 10 or shaped riser h 10 cm linear meter 15

92

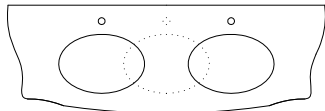

POCRI44 for 1 washbasin
L 172/156 P 58 H 1,5

123



POCRI45 for 2 washbasins
L 172/156 P 58 H 1,5

137

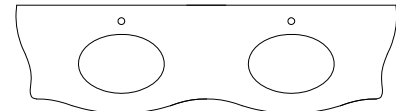

POCRI46
L 200/185 P 58 H 1,5

MARBLE TOP

for one or two undertop - overtop washbasin INCREASE +25% THICKNESS CM.3

POMA116 one undertop POMA115 two undertops
POMA216 one overtop POMA215 two overtops
L 173/157 P 59 H 2

- C1 51
- C2 63
- C3 79
- C4 86
- C5 97

POMA04 one undertop POMA02 two undertops
POMA204 one overtop POMA202 two overtops
L 173/157 P 59 H 2

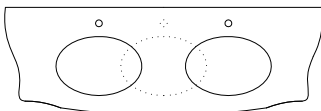

POMA117 undertop
POMA217 overtop
L 202/186 P 59 H 2

- C1 62
- C2 76
- C3 94
- C4 103
- C5 115

POMA43 undertop
POMA243 overtop
L 202/186 P 59 H 2

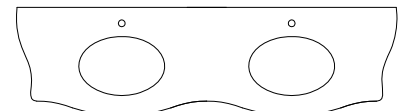

MIRRORS

83

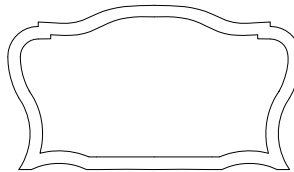

SP 267
L 150/140 H 90

ACCESSORIES

183

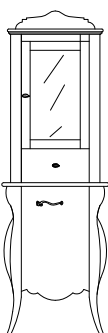

VT 260 Sx-Dx
L 65/53 P 38 H 180
two doors
one drawer

300

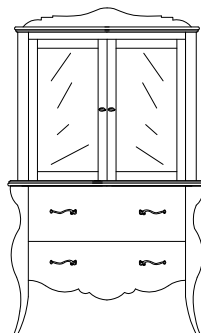

VT 263
L 106/100 P 41 H 180
two doors
two big drawers

175

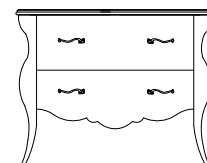

VT 264
L 106/100 P 41 H 85
two big drawers

100

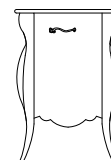

VT 261 Sx-Dx
L 65/53 P 38 H 85
one door

INTERNAL BOTTOM DRAWER - BIG DRAWER AND DOOR 'S COATING
STANDARD LACE AND ECO-LEATHER CORD SAME AS HANDLES **OR/CO/BR**
ON DEMAND CHOOSE COLOR LACE OR ECOLEATHER AND CORD ECOLEATHER **A PRICE LIST**

LINDEN WOOD

MAKEUP CORE central

115

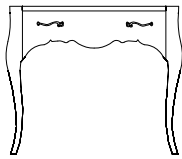

MO 278
 L 115/95 P 58 H 83
one big drawer

MAKEUP CORE

match it with cores or
 makeup core central

80

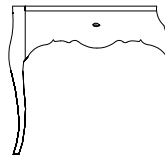

MO 219 sx
 L 87 P 48 H 83
one big drawer

80

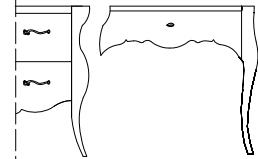

MO 219 dx
 L 87 P 48 H 83
one big drawer

MO 266
 MO 263
 MO 278

WOOD TOP

30



POLEG2399
 L 116/100 P 59 H 2

45



POCRI73
 L 113/99 P 58 H 1,5

CRYSTAL TOP

INCREASE +10% WAVE MANUFACTURE -
OPTIONAL linear riser h 4 cm linear meter 10 or shaped rider h 10 cm linear meter 15 MAX LENGTH 2,25ml

30



POCRI74 dx/sx
 L 88 P 48 H 1,5

add to matched core's POCRI

MARBLE TOP

INCREASE +25% THICKNESS CM.3 MAX LENGTH L 2,25 ml

add to matched core's POMA

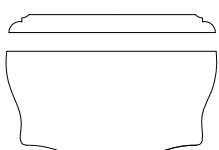

POMA102
 L 116/100 P 59 H 2

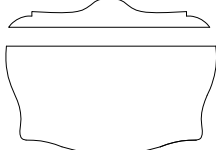

POMA103
 L 116/100 P 59 H 2

- C1 31
- C2 40
- C3 49
- C4 55
- C5 62

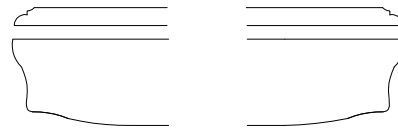

POMA104 dx/sx
 L 89 P 49 H 2

- C1 23
- C2 29
- C3 37
- C4 40
- C5 46

MIRRORS

100

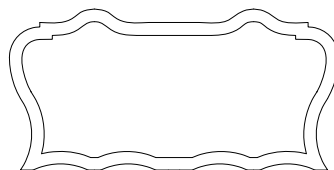

SP 263
 L 180/168 H 90

ACCESSORIES

33

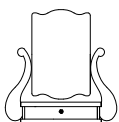

CD 94
 L 68 P 20 H 60
PETTINEUSE
one drawer

43



CD 95
 L 43 P 43 H 46
pouf seat
ecoleather smooth

48



CD 96
 L 43 P 43 H 46
pouf seat
ecoleather capitonné

increase for swarovski 6

FINISH'S INCREASE
ONECOLOR-BICOLOR

NERO F.-ROSSO M.-NOCE D.	PRICE LIST
ANTICATO 21 colors	PRICE LIST
PATINATO 21 colors	PRICE LIST
ANTICATO 4 metals	10%
PATINATO 4 metals	10%
LACCATO 21 colors	10%
BRILLANTE 21 colors	15%
MADREPERLA 21 colors	15%
FOGLIA oro/argento	15%
FOGLIA PATINATA oro/arg	15%

Pendant M

PEREMPTORY 1°COLOR INTERNAL AND EXTERNAL OF DOORS , DRAWERS , BIG DRAWERS AND MIRROR.
BICOLOR 2°COLOR INTERNAL AND EXTERNAL OF FURNITURE STRUCTURE - CABINET.

ON DEMAND BICOLOR WITH THE SAME FINISH
 PRICE LIST WITH INCREASE FOR THE CHOICE FINISH
ON DEMAND BICOLOR WITH TWO DIFFERENT FINISHES
 PRICE LIST WITH INCREASE CALCULATED ON THE HIGHER INCREASE CHOSEN FINISH

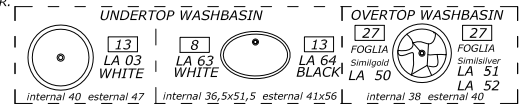

PEREMPTORY WITH MARBLE TOP LA 63 - LA 64
 INSTALL SIPHON WITH OVERALL LESS THAN CM. 9

IMPORTANT
 COMPATIBLE WITH
 WASHBASIN OF MAX SIZE
 LA 63 - LA 64 - LA 03

CORE
 for one or two undertop - overtop washbasin

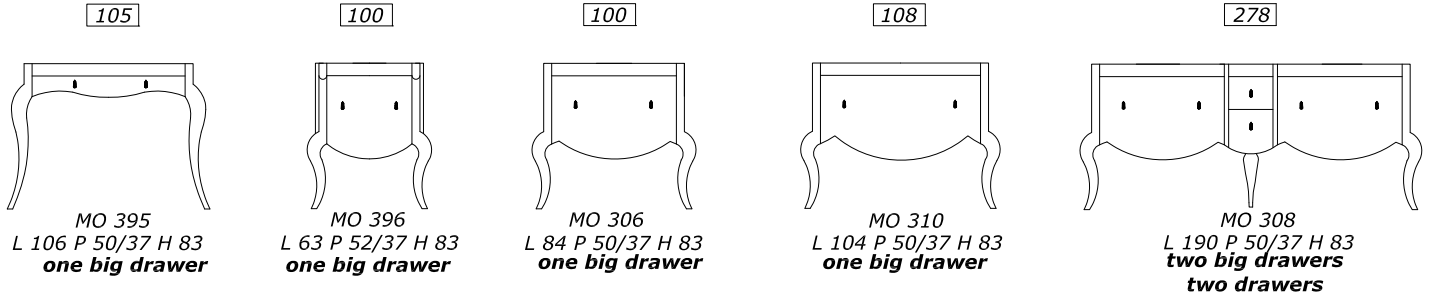

CERAMIC TOP

except of CORE MO 395

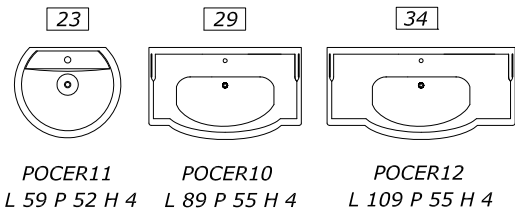

CRYSTAL TOP

with washbasin INCREASE +10% WAVE MANUFACTURE -
 OPTIONAL linear riser h 4 cm linear meter 10 or shaped riser h 10 cm linear meter 15

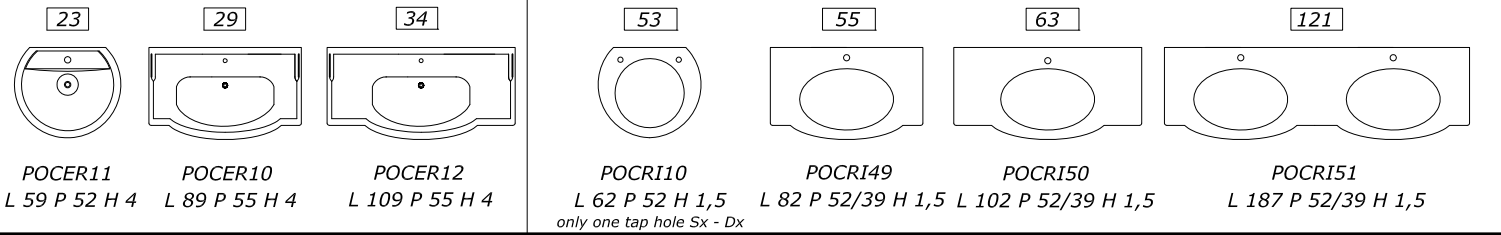

MARBLE TOP

for one or two undertop - overtop washbasin INCREASE +25% THICKNESS CM.3

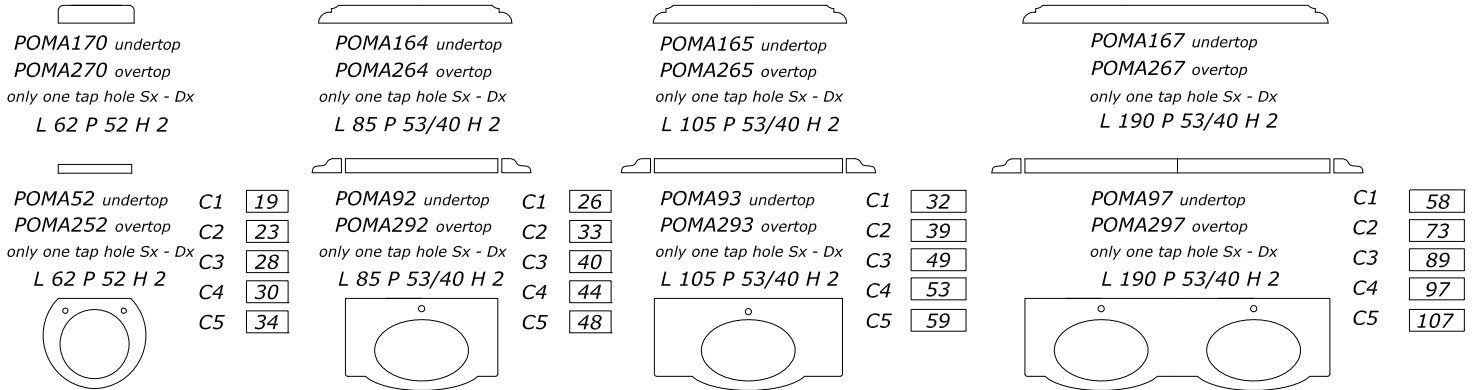

MIRRORS

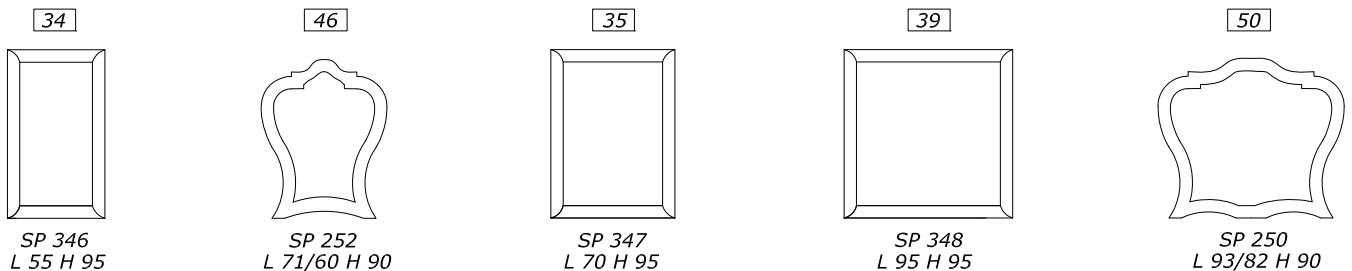

ACCESSORIES

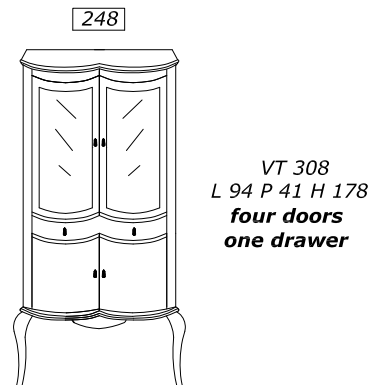
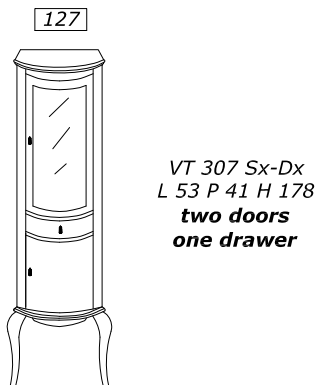

INTERNAL BOTTOM DRAWER - BIG DRAWER AND DOOR 'S COATING
STANDARD LACE AND ECO-LEATHER CORD SAME AS HANDLES **OR/CO/BR**
ON DEMAND CHOOSE COLOR LACE OR ECOLEATHER AND CORD ECOLEATHER **A PRICE LIST**

LINDEN WOOD

MAKEUP CORE central

MAKEUP CORE

match it with cores or
makeup core central

105

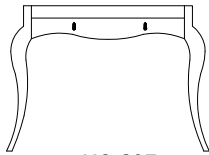

MO 397
L 106 P 50/37 H 83
one big drawer

68

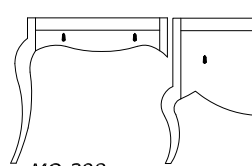

MO 398 sx
L 74 P 34/31 H 83
one big drawer

68

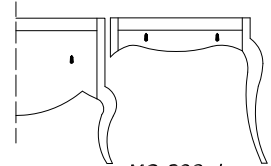

MO 398 dx
L 74 P 34/31 H 83
one big drawer

MO 395
MO 396
MO 306
MO 310
MO 308
MO 397

WOOD TOP

CRYSTAL TOP

INCREASE +10% WAVE MANUFACTURE -
OPTIONAL linear riser h 4 cm linear meter 10 or shaped rider h 10 cm linear meter 15 MAX LENGTH 2,25ml

30

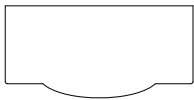

POLEG2329
L 105 P 53/40 H 2

34

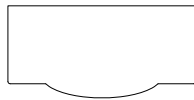

POCRI63
L 102 P 52/39 H 1,5

14



POCRI164 dx/sx
L 73 P 36 H 1,5

add to matched core's POCRI

MARBLE TOP

INCREASE +25% THICKNESS CM.3 MAX LENGTH L 2,25 ml

add to matched core's POMA

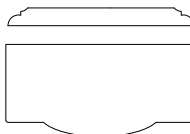

POMA143
L 105 P 53/40 H 2

C1 28
C2 35
C3 45
C4 49
C5 55



POMA144 dx/sx
L 74 P 36 H 2

C1 19
C2 24
C3 31
C4 34
C5 38

MIRRORS

44

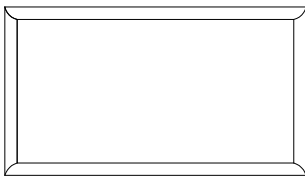

SP 349
L 170 H 95

83

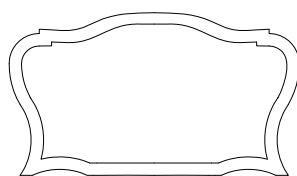

SP 267
L 150/140 H 90

47

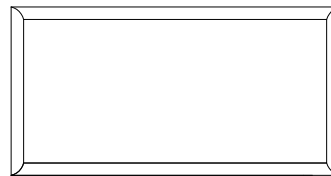

SP 345
L 185 H 95

100

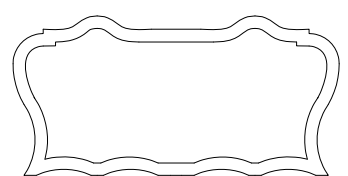

SP 263
L 180/168 H 90

ACCESSORIES

33

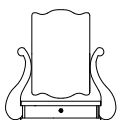

CD 94
L 68 P 20 H 60
PETTINEUSE
one drawer

43

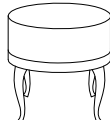

CD 72
L 43 P 43 H 46
pouf seat
ecoleather smooth

48



CD 73
L 43 P 43 H 46
pouf seat
ecoleather capitonné

FINISH'S INCREASE
ONECOLOR-BICOLOR

NERO F.-ROSSO M.-NOCE D.	PRICE LIST
ANTICATO 21 colors	PRICE LIST
PATINATO 21 colors	PRICE LIST
ANTICATO 4 metals	10%
PATINATO 4 metals	10%
LACCATO 21 colors	10%
BRILLANTE 21 colors	20%
MADREPERLA 21 colors	20%
FOGLIA oro/argento	10%
FOGLIA PATINATA oro/arg	10%

Pendant M

IMPORTANT
COMPATIBLE WITH
WASHBASIN OF MAX SIZE
LA 63 - LA 64

PEREMPTORY 1°COLOR INTERNAL AND EXTERNAL OF DOORS, DRAWERS, BIG DRAWERS UPPER CORE AND MIRROR
BICOLOR 2°COLOR INTERNAL AND EXTERNAL OF FURNITURE STRUCTURE - CABINET.

ON DEMAND BICOLOR WITH THE SAME FINISH

PRICE LIST WITH INCREASE FOR THE CHOICE FINISH

ON DEMAND BICOLOR WITH TWO DIFFERENT FINISHES

PRICE LIST WITH INCREASE CALCULATED ON THE HIGHER INCREASE CHOOSEN FINISH

UNDERTOP WASHBASIN		OVERTOP WASHBASIN	
8 LA 63 WHITE		13 LA 64 BLACK	
internal 36,5x51,5 external 41x56		internal 38 external 40	

PEREMPTORY WITH MARBLE TOP LA 63 - LA 64

INSTALL SIPHON WITH OVERALL LESS THAN CM. 9

CORE

for one or two undertop - overtop washbasin

105

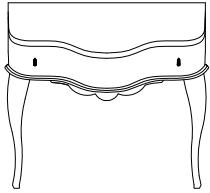

MO 385
L 106 P 58/41 H 82
one big drawer

130

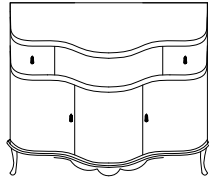

MO 300
L 106 P 58/41 H 82
**three doors
two drawers**

142

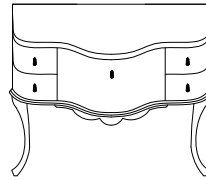

MO 386
L 106 P 58/41 H 82
**one big drawer
six drawers**

160

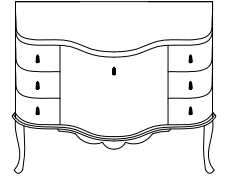

MO 301
L 106 P 58/41 H 82
**one big drawer
six drawers**

290

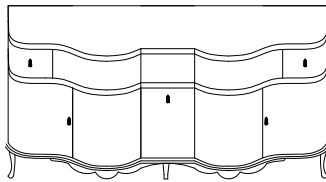

MO 303
L 174 P 58/41 H 82
**four doors
one basket
two drawers**

305

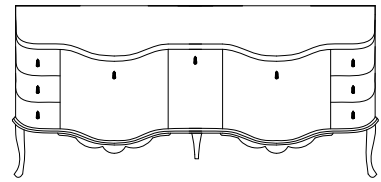

MO 304
L 189 P 58/41 H 82
**two big drawers
one basket
six drawers**

CERAMIC TOP

except of CORE MO 385

54

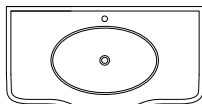

POCER59
L 110 P 61 H 4

CRYSTAL TOP

with washbasin INCREASE +10% WAVE MANUFACTURE -

OPTIONAL linear riser h 4 cm linear meter 10 or shaped riser h 10 cm linear meter 15

71

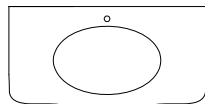

POCRI60
L 105 P 59/42 H 1,5

123

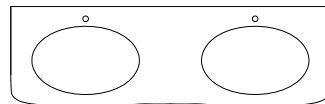

POCRI61
L 173 P 59/42 H 1,5

129

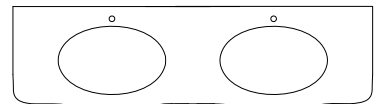

POCRI62
L 189 P 59/41 H 1,5

MARBLE TOP

for one or two undertop - overtop washbasin INCREASE +25% THICKNESS CM.3



POMA109 undertop
POMA209 overtop
L 107 P 60/43 H 2

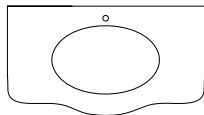

- C1 33
- C2 41
- C3 51
- C4 56
- C5 62



POMA100 undertop
POMA200 overtop
L 175 P 60/43 H 2

POMA101 undertop
POMA201 overtop
L 192 P 60/43 H 2

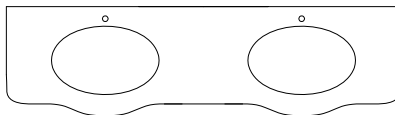

- C1 54
- C2 67
- C3 82
- C4 89
- C5 100

- C1 58
- C2 72
- C3 88
- C4 96
- C5 108

MIRRORS

35

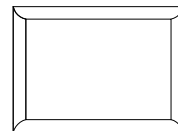

SP 347
L 95 H 70

39

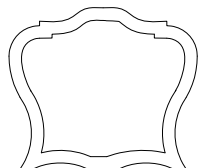

SP 348
L 95 H 95

50

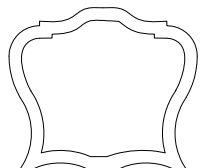

SP 250
L 93/82 H 90

ACCESSORIES

127

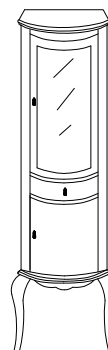

VT 345 Sx-Dx
L 53 P 41 H 178
**two doors
one drawer**

INTERNAL BOTTOM DRAWER - BIG DRAWER AND DOOR 'S COATING
STANDARD LACE AND ECO-LEATHER CORD SAME AS HANDLES **OR/CO/BR**
ON DEMAND CHOOSE COLOR LACE OR ECOLEATHER AND CORD ECOLEATHER **A PRICE LIST**

LINDEN WOOD

MAKEUP CORE central

MAKEUP CORE

match it with cores or
makeup core central

105

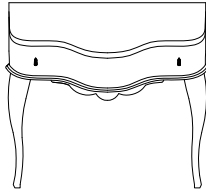

MO 387
L 106 P 58/41 H 82
one big drawer

68

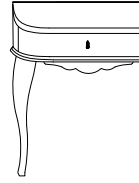

MO 388 sx
L 76 P 35 H 83
one big drawer

MO 385
MO 300
MO 386
MO 301
MO 303
MO 304
MO 387

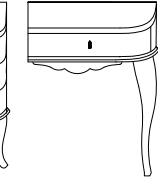

MO 388 dx
L 76 P 35 H 83
one big drawer

68

WOOD TOP

CRYSTAL TOP

INCREASE +10% WAVE MANUFACTURE -
 OPTIONAL linear riser h 4 cm linear meter 10 or shaped rider h 10 cm linear meter 15 MAX LENGTH 2,25ml

30



POLEG2315
L 107 P 60/43 H 2

42



POCRI65
L 106 P 59/42 H 1,5

23



POCRI66 dx/sx
L 77 P 37 H 1,5

add to matched core's POCRI

MARBLE TOP

INCREASE +25% THICKNESS CM.3 MAX LENGTH L 2,25 ml

add to matched core's POMA

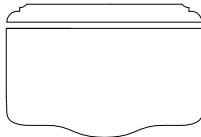

POMA108
L 107 P 60/43 H 2

C1 29
C2 37
C3 47
C4 52
C5 58



POMA113 dx/sx
L 77 P 37 H 2

C1 20
C2 25
C3 32
C4 35
C5 40

MIRRORS

44

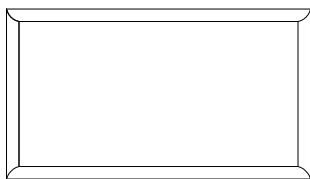

SP 349
L 170 H 95

83

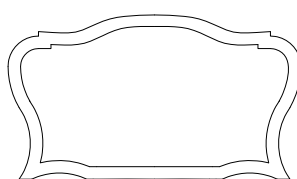

SP 267
L 150/140 H 90

47

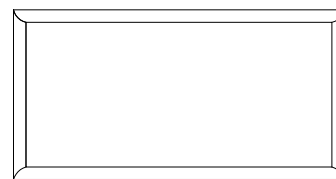

SP 345
L 185 H 95

100

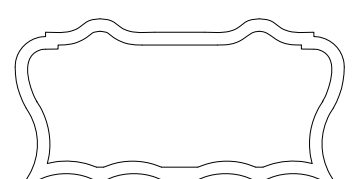

SP 263
L 180/168 H 90

ACCESSORIES

248

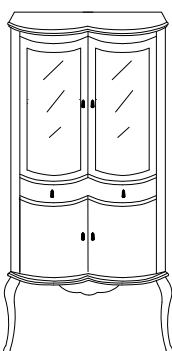

VT 346
L 94 P 42 H 178
**four doors
one drawer**

33

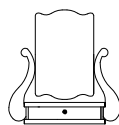

CD 94
L 68 P 20 H 60
**PETTINEUSE
one drawer**

43



CD 74
L 43 P 43 H 46
**pouf seat
ecoleather smooth**

48



CD 75
L 43 P 43 H 46
**pouf seat
ecoleather capitonné**

Aumento per swarovski 6

**FINISH'S INCREASE
ONECOLOR-BICOLOR**

NERO F.-ROSSO M.-NOCE D.	PRICE LIST
ANTICATO 21 colors	PRICE LIST
PATINATO 21 colors	PRICE LIST
ANTICATO 4 metals	10%
PATINATO 4 metals	10%
LACCATO 21 colors	10%
BRILLANTE 21 colors	20%
MADREPERLA 21 colors	20%
FOGLIA oro/argento	10%
FOGLIA PATINATA oro/arg	10%

FREGI



Knob - handle D

IMPORTANT
COMPATIBLE WITH
WASHBASIN OF MAX SIZE
LA 63 - LA 64

PEREMPORY 1°COLOR INTERNAL AND EXTERNAL OF DOORS, DRAWERS, BIG DRAWERS AND MIRROR
BICOLORE 2°COLOR INTERNAL AND EXTERNAL OF FURNITURE STRUCTURE, CABINET

ON DEMAND BICOLOR WITH THE SAME FINISH
PRICE LIST WITH INCREASE FOR THE CHOICE FINISH





ON DEMAND BICOLOR WITH TWO DIFFERENT FINISHES
PRICE LIST WITH INCREASE CALCULATED ON THE HIGHER INCREASE CHOOSEN FINISH

UNDERTOP WASHBASIN		OVERTOP WASHBASIN	
8 LA 63 WHITE		13 LA 64 BLACK	
internal 36,5x51,5 external 41x56		internal 38 external 40	

PEREMPORY WITH MARBLE TOP LA 63 - LA 64
INSTALL SIPHON WITH OVERALL LESS THAN CM. 9

CORE

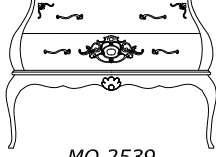
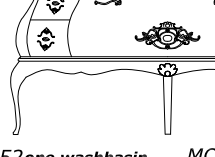
for one or two undertop - overtop washbasin

<p>135</p> <p>Increase friezes foglia OR/AE 8</p>  <p>MO 2507 L 130/110 P 64 H 83 one big drawer</p>	<p>205</p> <p>Increase friezes foglia OR/AE 8</p>  <p>MO 2550 L 132/119 P 56 H 83 one big drawer</p>	<p>279</p> <p>Increase friezes foglia OR/AE 15</p>  <p>MO 2551 L 132/119 P 56 H 83 one big drawer four drawers</p>	<p>248</p> <p>Increase friezes foglia OR/AE 8</p>  <p>MO 2539 L 132/119 P 56 H 83 two big drawers</p>	<p>373</p> <p>Increase friezes foglia OR/AE 15</p>  <p>MO 2552one washbasin L 185/172 P 63 H 83 one big drawer four drawers</p>	<p>345</p> <p>Increase friezes foglia OR/AE 15</p>  <p>MO 2553 two washbasins L 185/172 P 63 H 83 one big drawer two drawers</p>
--	---	---	---	--	---

CRYSTAL TOP

with washbasin INCREASE +10% WAVE MANUFACTURE - OPTIONAL linear riser h 4 cm linear meter 10 or shaped riser h 10 cm linear meter 15

<p>80</p>  <p>POCRI93 L 133/113 P 66 H 1,5</p>	<p>76</p>  <p>POCRI90 L 121/89 P 57 H 1,5</p>	<p>97</p>  <p>POCRI91 L 174/146 P 65 H 1,5</p>	<p>123</p>  <p>POCRI92 L 174/146 P 65 H 1,5</p>
--	--	--	--

MARBLE TOP

for one or two undertop - overtop washbasin INCREASE +25% THICKNESS CM.3

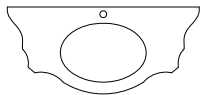
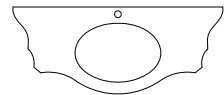
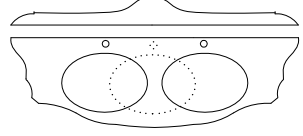
<p>POMA175 undertop POMA275 overtop L 135/115 P 67 H 2</p> <p>C1 39 C2 48 C3 59 C4 65 C5 73</p> 	<p>POMA160 undertop POMA260 overtop L 123/91 P 58 H 2</p> <p>C1 35 C2 44 C3 54 C4 59 C5 66</p> 	<p>POMA161 for 1 undertop POMA261 for 1 overtop POMA162 for 2 undertop POMA262 for 2 overtop L 177/148 P 65 H 2</p>	<p>POMA184 for 1 undertop POMA284 for 1 overtop POMA186 for 2 undertop POMA286 for 2 overtop L 177/148 P 65 H 2</p> <p>C1 52 C2 64 C3 79 C4 87 C5 97</p> 
--	--	---	--

MIRRORS

Increase friezes foglia OR/AE 4

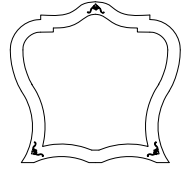
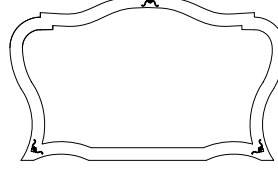
<p>60</p>  <p>SP 2550 L 93/82 H 90</p>	<p>85</p>  <p>SP 2552 L 150/140 H 90</p>
---	---

ACCESSORIES

Increase friezes foglia OR/AE 8

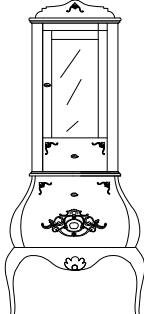
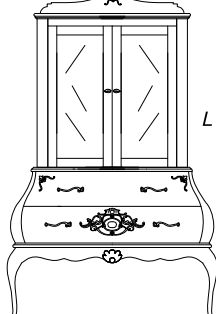
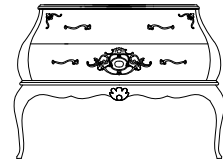
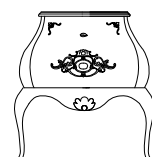
<p>206</p>  <p>VT 2550 Sx-Dx L 70/53 P 38 H 180 one door one drawer one big drawer</p>	<p>378</p>  <p>VT 2553 L 132/119 P 38 H 180 two doors two big drawers</p>	<p>250</p>  <p>VT 2549 L 132/119 P 38 H 85 two big drawers</p>	<p>120</p>  <p>VT 2551 L 70/53 P 38 H 85 one big drawer</p>
--	--	---	--

STANDARD FRIEZES SAME COLOR AND FINISH OF FURNITURE - MIRROR-CABINET
EXCLUDE NOCE DORATO - ROSSO MODENA - NERO FUMO -FOGLIA E FOGLIA PATINATA **A PRICE LIST**

ON DEMAND FRIEZE FOGLIA AVAILABLE FOR ALL FINISHES **WITH INCREASE**

FREGI

MY

INTERNAL BOTTOM DRAWER - BIG DRAWER AND DOOR 'S COATING

STANDARD LACE AND ECO-LEATHER CORD SAME AS HANDLES **OR/CO/BR**

ON DEMAND CHOOSE COLOR LACE OR ECOLEATHER AND CORD ECOLEATHER **A PRICE LIST**

LINEED WOOD

MAKEUP CORE central

MAKEUP CORE
match it with cores or
makeup core central

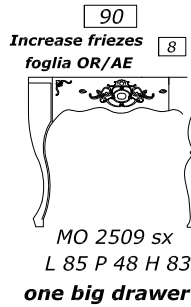
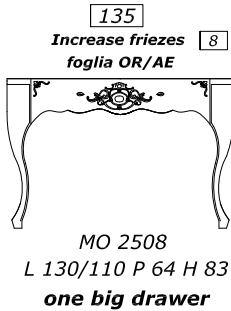

- MO 2507
- MO 2550
- MO 2551
- MO 2539
- MO 2552
- MO 2553
- MO 2508

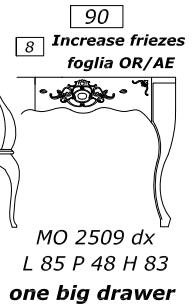

WOOD TOP

CRYSTAL TOP

increase +10% WAVE MANUFACTURE -

OPTIONAL linear riser h4 cm l.m. 10 or raised shaped h 10 cm l.m. 15 **MAX LENGTH 2,25ml**

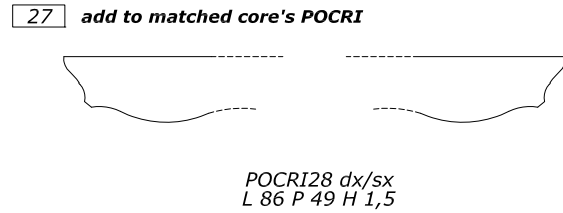
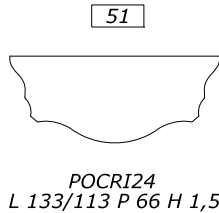
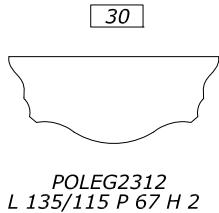

MARBLE TOP

INCREASE +25% THICKNESS CM.3 MAX LENGTH L 2,25 ml

add to matched core's POMA

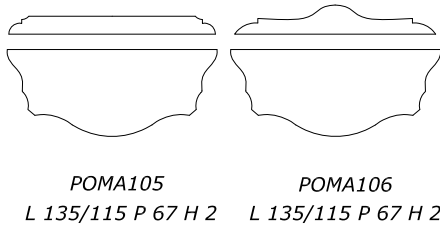

- C1 35
- C2 45
- C3 56
- C4 62
- C5 69

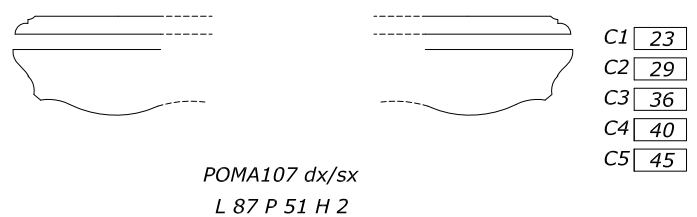

- C1 23
- C2 29
- C3 36
- C4 40
- C5 45

MIRRORS

Increase friezes foglia OR/AE 5

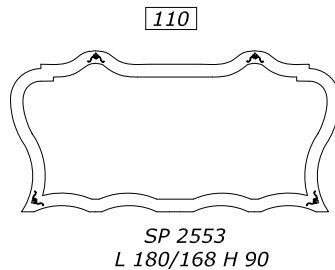

ACCESSORIES

FINISH'S INCREASE
ONECOLOR-BICOLOR

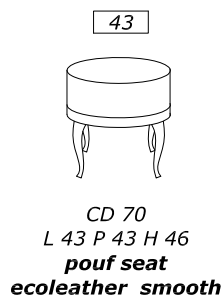
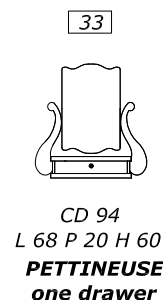

increase for swarovski 6

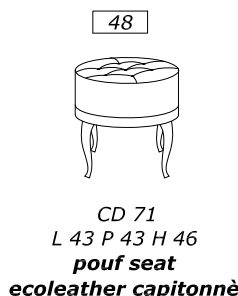



NERO F.-ROSSO M.-NOCE D.	PRICE LIST
ANTICATO 21 colors	PRICE LIST
PATINATO 21 colors	PRICE LIST
ANTICATO 4 metals	10%
PATINATO 4 metals	10%
LACCATO 21 colors	10%
BRILLANTE 21 colors	20%
MADREPERLA 21 colors	20%
FOGLIA oro/argento	10%
FOGLIA PATINATA oro/arg	10%

Knob - handle D

PEREMPTORY 1°COLOR INTERNAL AND EXTERNAL OF DOORS , DRAWERS , BIG DRAWERS UPPER CORE AND MIRROR.
BICOLOR 2°COLOR INTERNAL AND EXTERNAL OF FURNITURE STRUCTURE - CABINET.

ON DEMAND BICOLOR WITH THE SAME FINISH
 PRICE LIST WITH INCREASE FOR THE CHOICE FINISH
ON DEMAND BICOLOR WITH TWO DIFFERENT FINISHES
 PRICE LIST WITH INCREASE CALCULATED ON THE HIGHER INCREASE CHOOSEN FINISH

UNDERTOP WASHBASIN		OVERTOP WASHBASIN	
8 LA 63 WHITE		13 LA 64 BLACK	
internal 36,5x51,5 esternal 41x56		internal 38 esternal 40	

PEREMPTORY WITH MARBLE TOP LA 63 - LA 64
 INSTALL SIPHON WITH OVERALL LESS THAN CM. 9

IMPORTANT
 COMPATIBLE WITH
 WASHBASIN OF MAX SIZE
 LA 63 - LA 64

CORE
 for one or two undertop - overtop washbasin

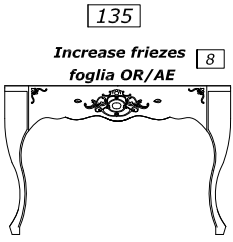

MO 2507
 L 130/110 P 64 H 82
 one big drawer

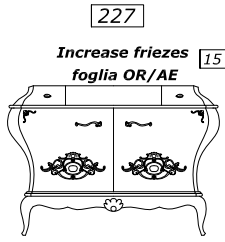

MO 2555
 L 132/110 P 60 H 82
 two doors
 two drawers

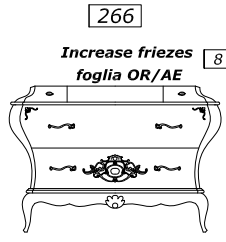

MO 2537
 L 132/110 P 60 H 82
 two big drawers
 two drawers

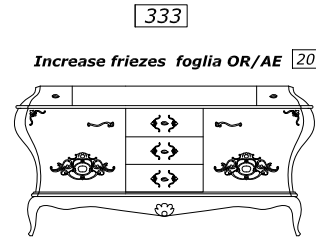

MO 2556
 L 176/152 P 60 H 82
 two doors
 three drawers

CRYSTAL TOP

with washbasin INCREASE +10% WAVE MANUFACTURE - OPTIONAL linear riser h 4 cm linear meter 10 or shaped riser h 10 cm linear meter 15

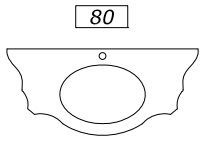

POCRI93
 L 133/115 P 66 H 1,5

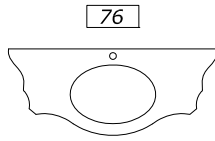

POCRI40
 L 123/104 P 59 H 1,5

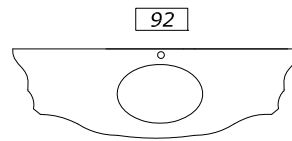

POCRI41
 L 166/148 P 59 H 1,5

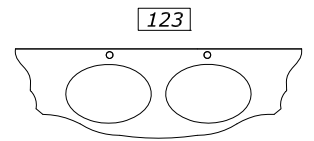

POCRI42
 L 166/148 P 59 H 1,5

MARBLE TOP

for one or two undertop - overtop washbasin INCREASE +25% THICKNESS CM.3

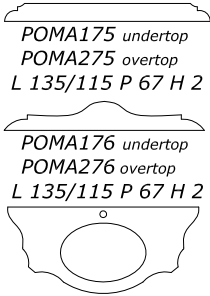

POMA175 undertop
 POMA275 overtop
 L 135/115 P 67 H 2

- C1 39
- C2 48
- C3 59
- C4 65
- C5 73

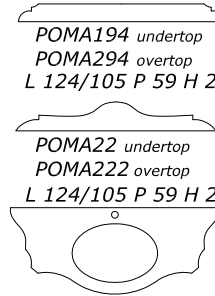

POMA194 undertop
 POMA294 overtop
 L 124/105 P 59 H 2

- C1 36
- C2 45
- C3 56
- C4 61
- C5 68

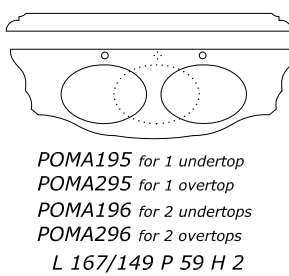

POMA195 for 1 undertop
 POMA295 for 1 overtop
 POMA196 for 2 undertops
 POMA296 for 2 overtops
 L 167/149 P 59 H 2

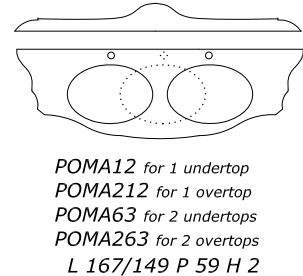

POMA12 for 1 undertop
 POMA212 for 1 overtop
 POMA63 for 2 undertops
 POMA263 for 2 overtops
 L 167/149 P 59 H 2

- C1 50
- C2 62
- C3 76
- C4 83
- C5 93

MIRRORS

Increase friezes foglia OR/AE 4

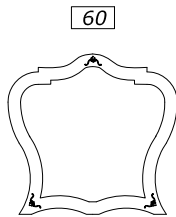

SP 2550
 L 93/82 H 90

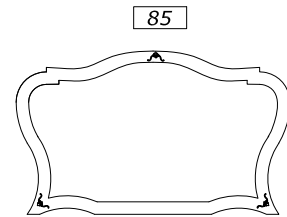

SP 2552
 L 150/140 H 90

ACCESSORIES

Increase friezes foglia OR/AE 8

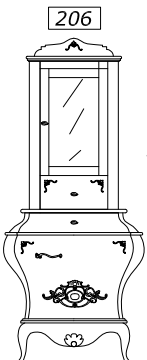

VT 2555 Sx-Dx
 L 71/53 P 38 H 180
 two doors
 two drawers

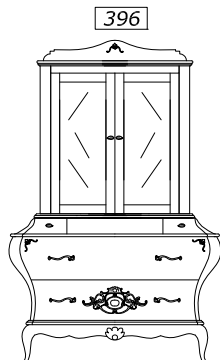

VT 2557
 L 132/110 P 38 H 180
 two doors
 two drawers
 two big drawers

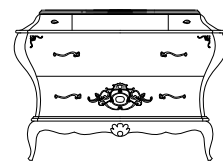

VT 2554
 L 132/110 P 38 H 85
 two big drawers
 two drawers

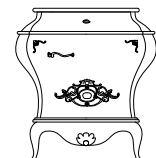

VT 2556 Sx-Dx
 L 71/53 P 38 H 85
 one door
 one drawer

STANDARD FRIEZES SAME COLOR AND FINISH OF FURNITURE - MIRROR-CABINET
EXCLUDE NOCE DORATO - ROSSO MODENA - NERO FUMO -FOGLIA E FOGLIA PATINATA **A PRICE LIST**

FREGI

MY

ON DEMAND FRIEZE FOGLIA AVAILABLE FOR ALL FINISHES **WITH INCREASE**

INTERNAL BOTTOM DRAWER - BIG DRAWER AND DOOR 'S COATING

STANDARD LACE AND ECO-LEATHER CORD SAME AS HANDLES **OR/CO/BR**

ON DEMAND CHOOSE COLOR LACE OR ECOLEATHER AND CORD ECOLEATHER **A PRICE LIST**

LINDEN WOOD

MAKEUP CORE central

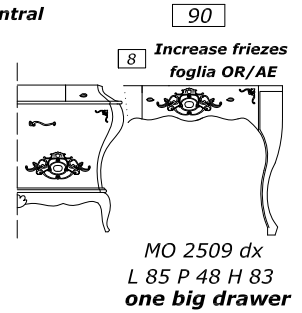
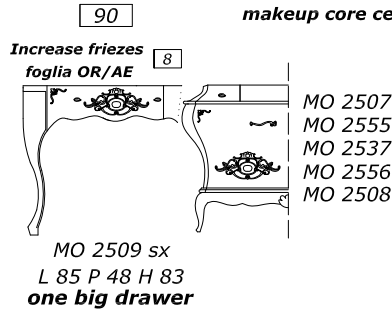
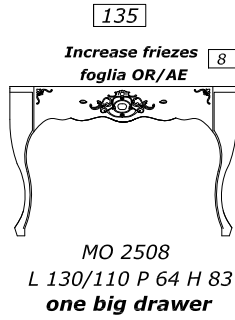

MAKEUP CORE

match it with cores or makeup core central

WOOD TOP

CRYSTAL TOP

INCREASE +10% WAVE MANUFACTURE -

OPTIONAL linear riser h 4 cm linear meter 10 or shaped rider h 10 cm linear meter 15 MAX LENGTH 2,25ml

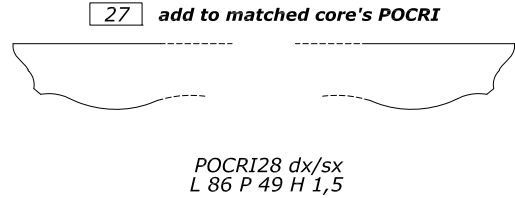
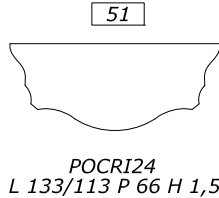
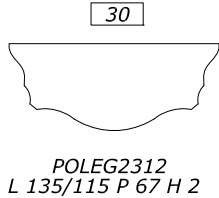

MARBLE TOP

INCREASE +25% THICKNESS CM.3 MAX LENGTH L 2,25 ml

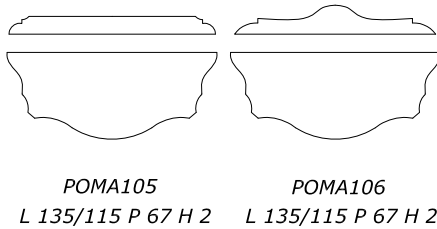

- C1 35
- C2 45
- C3 56
- C4 62
- C5 69

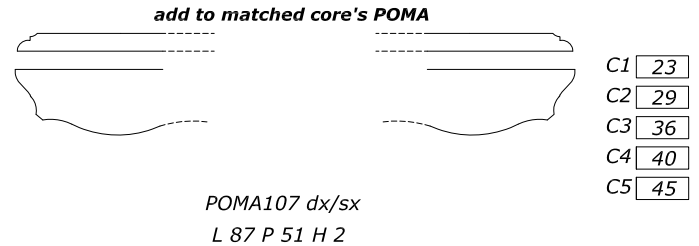

MIRRORS

Increase friezes foglia OR/AE 5

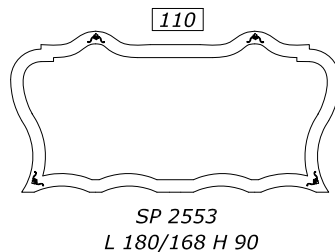

ACCESSORIES

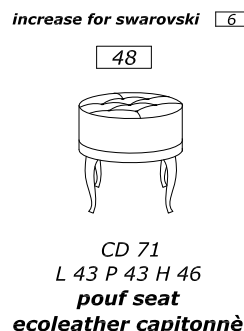
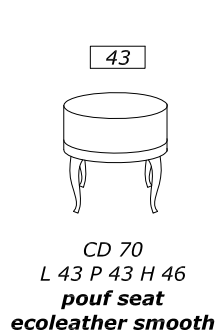
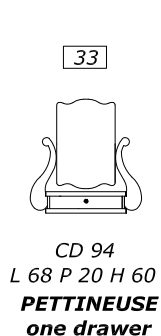

**FINISH'S INCREASE
ONECOLOR-BICOLOR**

NERO F.-ROSSO M.-NOCE D.	PRICE LIST
ANTICATO 21 colors	PRICE LIST
PATINATO 21 colors	PRICE LIST
ANTICATO 4 metals	10%
PATINATO 4 metals	10%
LACCATO 21 colors	10%
BRILLANTE 21 colors	20%
MADREPERLA 21 colors	20%
FOGLIA oro/argento	10%
FOGLIA PATINATA oro/arg	10%

Knob - handle B

IMPORTANT
COMPATIBLE WITH
WASHBASIN OF MAX SIZE
LA 63 - LA 64

PEREMPTORY 1°COLOR INTERNAL AND EXTERNAL OF DOORS , DRAWERS , BIG DRAWERS AND MIRROR
BICOLORE 2°COLOR INTERNAL AND EXTERNAL OF FURNITURE STRUCTURE , CABINET

ON DEMAND BICOLOR WITH THE SAME FINISH
PRICE LIST WITH INCREASE FOR THE CHOICE FINISH
ON DEMAND BICOLOR WITH TWO DIFFERENT FINISHES
PRICE LIST WITH INCREASE CALCULATED ON THE HIGHER INCREASE CHOSEN FINISH

UNDERTOP WASHBASIN		OVERTOP WASHBASIN	
8		13	
LA 63	WHITE	LA 64	BLACK
internal 36,5x51,5 external 41x56		internal 38 external 40	

PEREMPTORY WITH MARBLE TOP LA 63 - LA 64
INSTALL SIPHON WITH OVERALL LESS THAN CM. 9

CORE

for one undertop - overtop washbasin

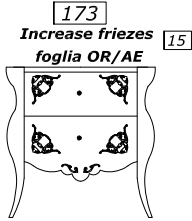

MO 253
L 90/72 P 58 H 83
two big drawers

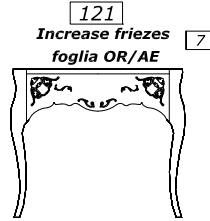

MO 254
L 115/95 P 58 H 83
one big drawer

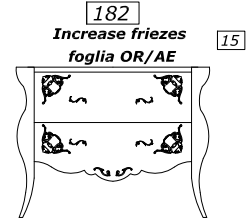

MO 246
L 115/95 P 58 H 83
two big drawers

CRYSTAL TOP

with washbasin INCREASE +10% WAVE MANUFACTURE - OPTIONAL linear riser h 4 cm linear meter 10 or shaped riser h 10 cm linear meter 15

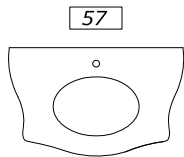

POCRI15
L 89/75 P 58 H 1,5

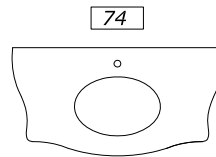

POCRI43
L 113/99 P 58 H 1,5

MARBLE TOP

for one undertop - overtop washbasin INCREASE +25% THICKNESS CM.3

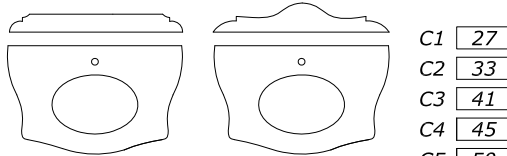

POMA118 undertop POMA119 undertop
POMA218 overtop POMA219 overtop
L 91/77 P 59 H 2 L 91/77 P 59 H 2

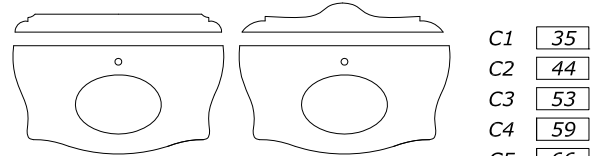

POMA139 undertop POMA24 undertop
POMA239 overtop POMA224 overtop
L 116/100 P 59 H 2 L 116/100 P 59 H 2

MIRRORS

Increase friezes foglia OR/AE 5



SP 244
L 71/60 H 90

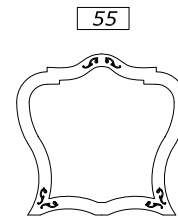

SP 245
L 93/82 H 90

ACCESSORIES

7

Increase friezes foglia OR/AE

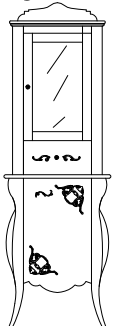

190
VT 245 Sx-Dx
L 65/53 P 38 H 180
two doors
one drawer

15

Increase friezes foglia OR/AE

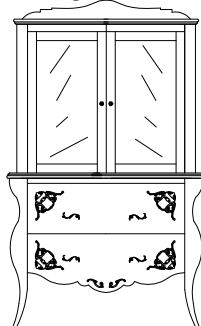

231
VT 248
L 106/100 P 41 H 180
two doors
two big drawers

Increase friezes foglia OR/AE 15

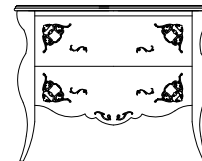

186
VT 249
L 106/100 P 41 H 85
two big drawers

Increase friezes foglia OR/AE 7



105
VT 246 Sx-Dx
L 65/53 P 38 H 85
one door

STANDARD FRIEZES SAME COLOR AND FINISH OF FURNITURE - MIRROR-CABINET
EXCLUDE NOCE DORATO - ROSSO MODENA - NERO FUMO -FOGLIA E FOGLIA PATINATA **A PRICE LIST**

FREGI

MY

ON DEMAND FRIEZE FOGLIA AVAILABLE FOR ALL FINISHES **WITH INCREASE**

INTERNAL BOTTOM DRAWER - BIG DRAWER AND DOOR 'S COATING

STANDARD LACE AND ECO-LEATHER CORD SAME AS HANDLES **OR/CO/BR**

ON DEMAND CHOOSE COLOR LACE OR ECOLEATHER AND CORD ECOLEATHER **A PRICE LIST**

LINDEN WOOD

MAKEUP CORE central

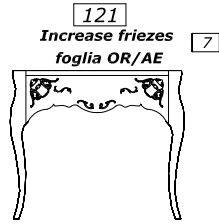

MO 229
L 115/95 P 58 H 83
one big drawer

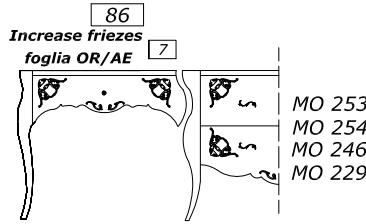

MO 224 sx
L 87 P 48 H 83
one big drawer

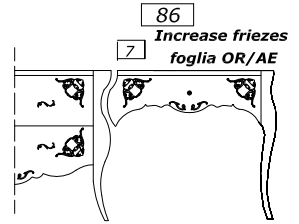

MO 224 dx
L 87 P 48 H 83
one big drawer

MAKEUP CORE

match it with cores or
makeup core central

WOOD TOP

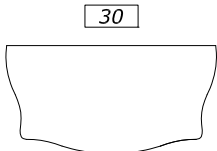

POLEG2399
L 116/100 P 59 H 2

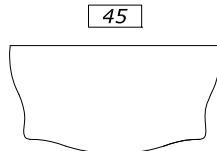

POCRI73
L 113/99 P 58 H 1,5

CRYSTAL TOP

INCREASE +10% WAVE MANUFACTURE -
OPTIONAL linear riser h 4 cm linear meter 10 or shaped rider h 10 cm linear meter 15 MAX LENGTH 2,25ml

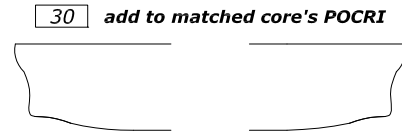

POCRI174 dx/sx
L 88 P 48 H 1,5

MARBLE TOP

INCREASE +25% THICKNESS CM.3 MAX LENGTH L 2,25 ml

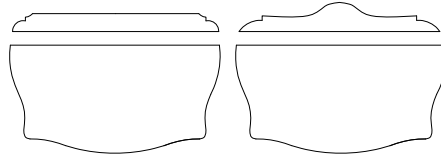

POMA102 L 116/100 P 59 H 2
POMA103 L 116/100 P 59 H 2

- C1 31
- C2 40
- C3 49
- C4 55
- C5 62

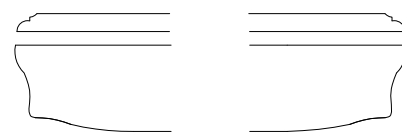

POMA104 dx/sx
L 89 P 49 H 2

- C1 23
- C2 29
- C3 37
- C4 40
- C5 46

MIRRORS

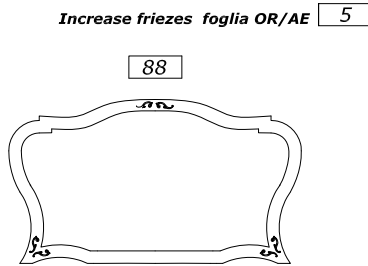

SP 247
L 150/140 H 90

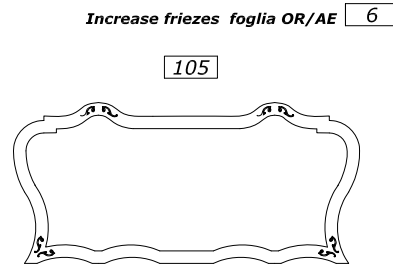

SP 248
L 180/168 H 90

ACCESSORIES

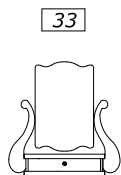

CD 94
L 68 P 20 H 60
PETTINEUSE
one drawer



CD 95
L 43 P 43 H 46
pouf seat
ecoleather smooth



CD 96
L 43 P 43 H 46
pouf seat
ecoleather capitonné

increase for swarovski 6

**FINISH'S INCREASE
ONECOLOR-BICOLOR**

NERO F.-ROSSO M.-NOCE D.	PRICE LIST
ANTICATO 21 colors	PRICE LIST
PATINATO 21 colors	PRICE LIST
ANTICATO 4 metals	10%
PATINATO 4 metals	10%
LACCATO 21 colors	10%
BRILLANTE 21 colors	20%
MADREPERLA 21 colors	20%
FOGLIA oro/argento	10%
FOGLIA PATINATA oro/arg	10%

Knob - handle B

IMPORTANT
COMPATIBLE WITH
WASHBASIN OF MAX SIZE
LA 63 - LA 64

PEREMPTORY 1°COLOR BICOLORE 2°COLOR INTERNAL AND EXTERNAL OF DOORS, DRAWERS, BIG DRAWERS AND MIRROR
INTERNAL AND EXTERNAL OF FURNITURE STRUCTURE, CABINET

ON DEMAND BICOLOR WITH THE SAME FINISH
PRICE LIST WITH INCREASE FOR THE CHOICE FINISH
ON DEMAND BICOLOR WITH TWO DIFFERENT FINISHES
PRICE LIST WITH INCREASE CALCULATED ON THE HIGHER INCREASE CHOSEN FINISH

UNDERTOP WASHBASIN		OVERTOP WASHBASIN	
8 LA 63 WHITE		13 LA 64 BLACK	
internal 36,5x51,5 esternal 41x56		internal 38 esternal 40	

PEREMPTORY WITH MARBLE TOP LA 63 - LA 64
INSTALL SIPHON WITH OVERALL LESS THAN CM. 9

CORE

for one or two undertop - overtop washbasin

240

Increase friezes foglia OR/AE 15

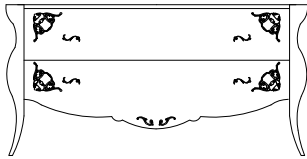

MO 234
L 173/153 P 58 H 83
two big drawers

300

Increase friezes foglia OR/AE 30

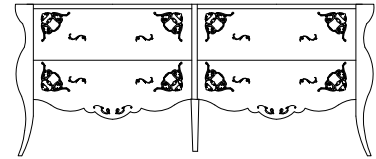

MO 248
L 203/182 P 58 H 83
four big drawers

CRYSTAL TOP

with washbasin INCREASE +10% WAVE MANUFACTURE - OPTIONAL linear riser h 4 cm linear meter 10 or shaped riser h 10 cm linear meter 15

92

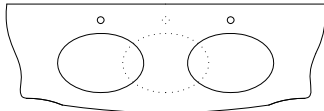

POCRI44 for 1 washbasin
L 172/156 P 58 H 1,5

123



POCRI45 for 2 washbasins
L 172/156 P 58 H 1,5

137

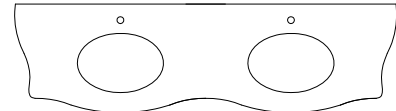

POCRI46
L 200/185 P 58 H 1,5

MARBLE TOP

for one or two undertop - overtop washbasin INCREASE +25% THICKNESS CM.3

POMA116 one undertop POMA115 two undertops
POMA216 one overtop POMA215 two overtops
L 173/157 P 59 H 2

- C1 51
- C2 63
- C3 79
- C4 86
- C5 97

POMA04 one undertop POMA02 two undertops
POMA204 one overtop POMA202 two overtops
L 173/157 P 59 H 2

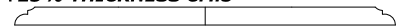
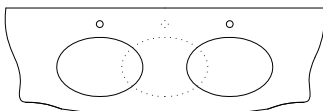

POMA117 undertop
POMA217 overtop
L 202/186 P 59 H 2

- C1 62
- C2 76
- C3 94
- C4 103
- C5 115



POMA43 undertop
POMA243 overtop
L 202/186 P 59 H 2

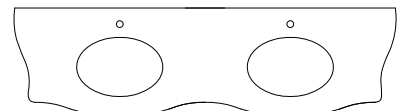

MIRRORS

Increase friezes foglia OR/AE 5

88

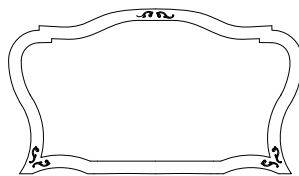

SP 247
L 150/140 H 90

ACCESSORIES

7

Increase friezes foglia OR/AE

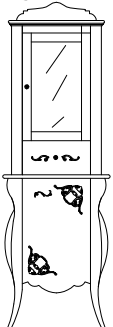

190
VT 245 Sx-Dx
L 65/53 P 38 H 180
two doors
one drawer

15

Increase friezes foglia OR/AE

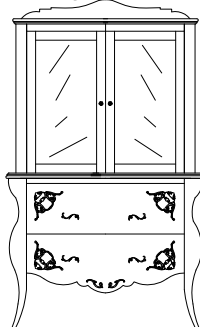

231
VT 248
L 106/100 P 41 H 180
two doors
two big drawers

Increase friezes foglia OR/AE 15

186

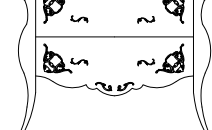

VT 249
L 106/100 P 41 H 85
two big drawers

Increase friezes foglia OR/AE 7

105



VT 246 Sx-Dx
L 65/53 P 38 H 85
one door

STANDARD FRIEZES SAME COLOR AND FINISH OF FURNITURE - MIRROR-CABINET
EXCLUDE NOCE DORATO - ROSSO MODENA - NERO FUMO -FOGLIA E FOGLIA PATINATA **A PRICE LIST**

ON DEMAND FRIEZE FOGLIA AVAILABLE FOR ALL FINISHES **WITH INCREASE**

FREGI

MY

INTERNAL BOTTOM DRAWER - BIG DRAWER AND DOOR 'S COATING

STANDARD LACE AND ECO-LEATHER CORD SAME AS HANDLES **OR/CO/BR**

ON DEMAND CHOOSE COLOR LACE OR ECOLEATHER AND CORD ECOLEATHER **A PRICE LIST**

LINDEN WOOD

MAKEUP CORE central

MAKEUP CORE

match it with cores or
makeup core central

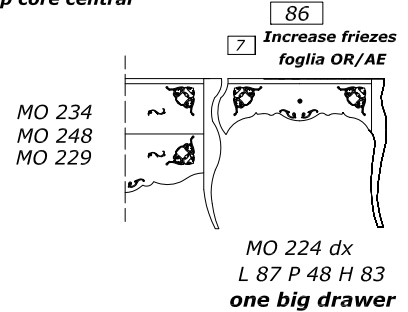
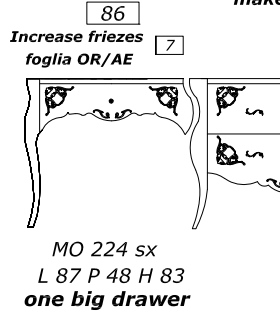
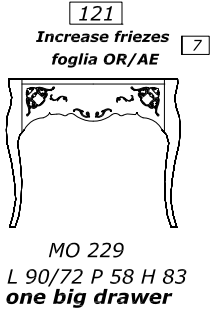

WOOD TOP

CRYSTAL TOP

INCREASE +10% WAVE MANUFACTURE -
OPTIONAL linear riser h 4 cm linear meter 10 or shaped rider h 10 cm linear meter 15 MAX LENGTH 2,25ml

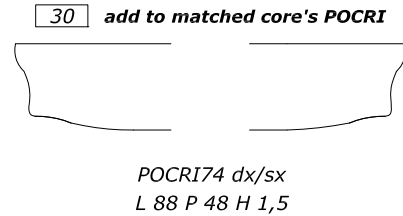
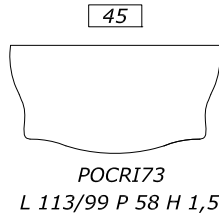
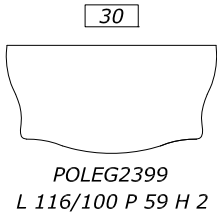

MARBLE TOP

INCREASE +25% THICKNESS CM.3 MAX LENGTH L 2,25 ml

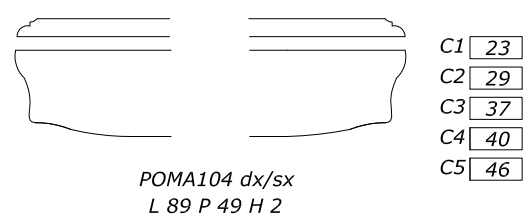
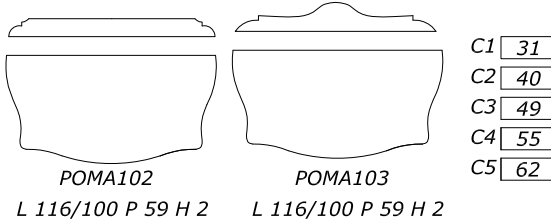

MIRRORS

Increase friezes foglia OR/AE 6

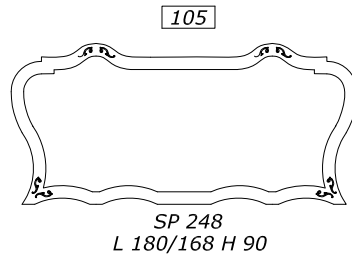

ACCESSORIES

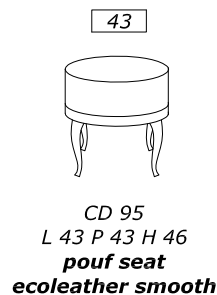
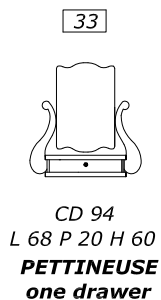

increase for swarovski 6

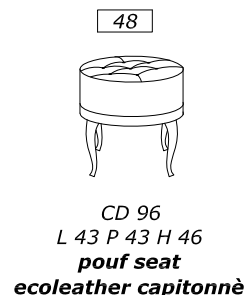

FINISH'S INCREASE
ONECOLOR-BICOLOR

NERO F.-ROSSO M.-NOCE D.	PRICE LIST
ANTICATO 21 colors	PRICE LIST
PATINATO 21 colors	PRICE LIST
ANTICATO 4 metals	10%
PATINATO 4 metals	10%
LACCATO 21 colors	10%
BRILLANTE 21 colors	20%
MADREPERLA 21 colors	20%
FOGLIA oro/argento	10%
FOGLIA PATINATA oro/arg	10%

Knob Q

PEREMPTORY 1°COLOR INTERNAL AND EXTERNAL OF DOORS , DRAWERS , BIG DRAWERS AND MIRROR.
BICOLOR 2°COLOR INTERNAL AND EXTERNAL OF FURNITURE STRUCTURE - CABINET.

ON DEMAND BICOLOR WITH THE SAME FINISH
 PRICE LIST WITH INCREASE FOR THE CHOICE FINISH
ON DEMAND BICOLOR WITH TWO DIFFERENT FINISHES
 PRICE LIST WITH INCREASE CALCULATED ON THE HIGHER INCREASE CHOSEN FINISH

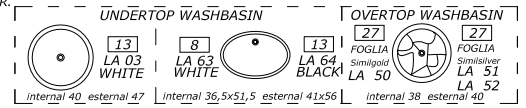

PEREMPTORY WITH MARBLE TOP LA 63 - LA 64
 INSTALL SIPHON WITH OVERALL LESS THAN CM. 9

IMPORTANT
 COMPATIBLE WITH
 WASHBASIN OF MAX SIZE
 LA 63 - LA 64 - LA 03

CORE
 for one or two undertop - overtop washbasin

108
 Increase friezes foglia OR/AE 7

 MO 235
 L 106 P 50/37 H 83
one big drawer

104
 Increase friezes foglia OR/AE 10

 MO 239
 L 63 P 52/37 H 83
one big drawer

104
 Increase friezes foglia OR/AE 10

 MO 241
 L 84 P 50/37 H 83
one big drawer

112
 Increase friezes foglia OR/AE 10

 MO 244
 L 104 P 50/37 H 83
one big drawer

287
 Increase friezes foglia OR/AE 20

 MO 294
 L 190 P 50/37 H 83
two big drawers

CERAMIC TOP
 except of CORE MO 235

23

 POCER11
 L 59 P 52 H 4

29

 POCER10
 L 89 P 55 H 4

34

 POCER12
 L 109 P 55 H 4

CRYSTAL TOP
 with washbasin INCREASE +10% WAVE MANUFACTURE -
 OPTIONAL linear riser h 4 cm linear meter 10 or shaped riser h 10 cm linear meter 15

53

 POCRI10
 L 62 P 52 H 1,5
 only one tap hole Sx - Dx

55

 POCRI49
 L 82 P 52/39 H 1,5

63

 POCRI50
 L 102 P 52/39 H 1,5

121

 POCRI51
 L 187 P 52/39 H 1,5

MARBLE TOP

for one undertop - overtop washbasin INCREASE +25% THICKNESS CM.3

POMA170 undertop
 POMA270 overtop
 only one tap hole Sx - Dx
 L 62 P 52 H 2

POMA164 undertop
 POMA264 overtop
 only one tap hole Sx - Dx
 L 85 P 53/40 H 2

POMA165 undertop
 POMA265 overtop
 only one tap hole Sx - Dx
 L 105 P 53/40 H 2

POMA167 undertop
 POMA267 overtop
 only one tap hole Sx - Dx
 L 190 P 53/40 H 2

POMA52 undertop C1 19
 POMA252 overtop C2 23
 only one tap hole Sx - Dx C3 28
 L 62 P 52 H 2 C4 30
 C5 34

POMA92 undertop C1 26
 POMA292 overtop C2 33
 only one tap hole Sx - Dx C3 40
 L 85 P 53/40 H 2 C4 44
 C5 48

POMA93 undertop C1 32
 POMA293 overtop C2 39
 only one tap hole Sx - Dx C3 49
 L 105 P 53/40 H 2 C4 53
 C5 59

POMA97 undertop C1 58
 POMA297 overtop C2 73
 only one tap hole Sx - Dx C3 89
 L 190 P 53/40 H 2 C4 97
 C5 107

MIRRORS

Increase friezes foglia OR/AE 4
 36

 SP 290
 L 55 H 95

Increase friezes foglia OR/AE 5
 51

 SP 244
 L 71/60 H 90

Increase friezes foglia OR/AE 4
 37

 SP 291
 L 95 H 70

Increase friezes foglia OR/AE 4
 40

 SP 292
 L 95 H 95

Increase friezes foglia OR/AE 4
 60

 SP 2550
 L 93/82 H 90

ACCESSORIES

Increase friezes foglia OR/AE 7
 130

 VT 241 Sx-Dx
 L 53 P 41 H 178
two doors
one drawer

Increase friezes foglia OR/AE 14
 254

 VT 242
 L 94 P 41 H 178
four doors
one drawer

STANDARD FRIEZES SAME COLOR AND FINISH OF FURNITURE - MIRROR-CABINET
EXCLUDE NOCE DORATO - ROSSO MODENA - NERO FUMO -FOGLIA E FOGLIA PATINATA **A PRICE LIST**

ON DEMAND FRIEZE FOGLIA AVAILABLE FOR ALL FINISHES **WITH INCREASE**

FREGI

MY

INTERNAL BOTTOM DRAWER - BIG DRAWER AND DOOR 'S COATING

STANDARD LACE AND ECO-LEATHER CORD SAME AS HANDLES **OR/CO/BR**

ON DEMAND CHOOSE COLOR LACE OR ECOLEATHER AND CORD ECOLEATHER **A PRICE LIST**

LINDEN WOOD

MAKEUP CORE central

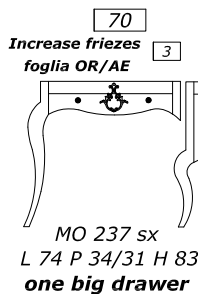
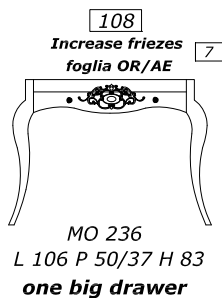

MAKEUP CORE

match it with cores or
makeup core central

MO 235
MO 239
MO 241
MO 244
MO 294
MO 236

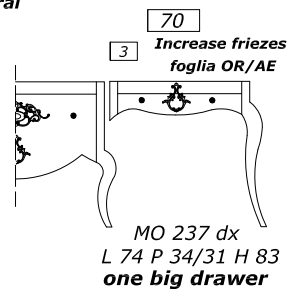

WOOD TOP

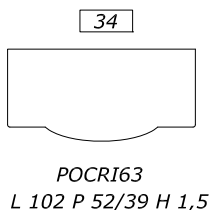
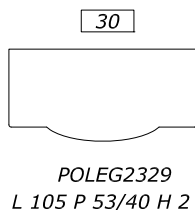

CRYSTAL TOP

INCREASE +10% WAVE MANUFACTURE -
OPTIONAL linear riser h 4 cm linear meter **10** or shaped rider h 10 cm linear meter **15** MAX LENGTH 2,25ml

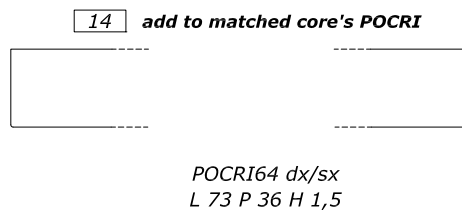

MARBLE TOP

INCREASE +25% THICKNESS CM.3 MAX LENGTH L 2,25 ml

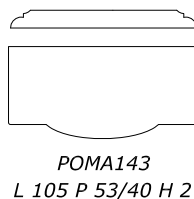

C1 **28**
C2 **35**
C3 **45**
C4 **49**
C5 **55**

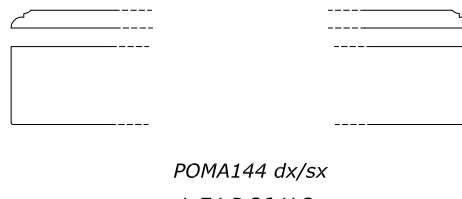

C1 **19**
C2 **24**
C3 **31**
C4 **34**
C5 **38**

MIRRORS

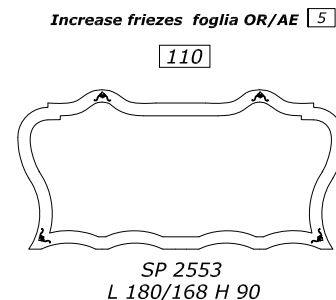
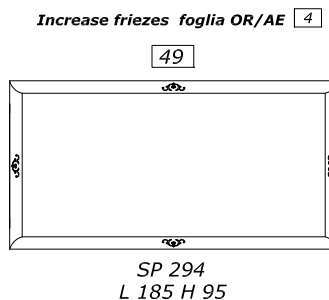
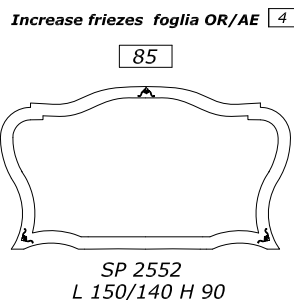
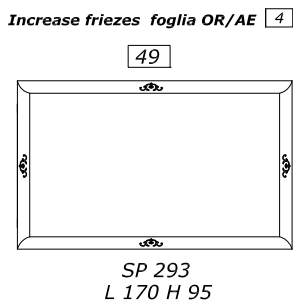

ACCESSORIES

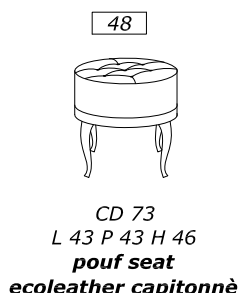
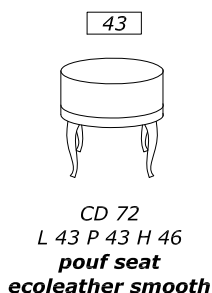
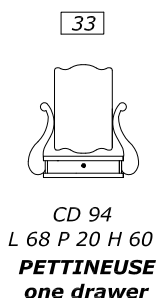

FINISH'S INCREASE
ONECOLOR-BICOLOR

NERO F.-ROSSO M.-NOCE D.	PRICE LIST
ANTICATO 21 colors	PRICE LIST
PATINATO 21 colors	PRICE LIST
ANTICATO 4 metals	10%
PATINATO 4 metals	10%
LACCATO 21 colors	10%
BRILLANTE 21 colors	20%
MADREPERLA 21 colors	20%
FOGLIA oro/argento	10%
FOGLIA PATINATA oro/arg	10%

Knob Q

**IMPORTANT
COMPATIBLE WITH
WASHBASIN OF MAX SIZE
LA 63 - LA 64**

PEREMPORY 1°COLOR INTERNAL AND EXTERNAL OF DOORS , DRAWERS , BIG DRAWERS UPPER CORE AND MIRROR.
BICOLOR 2°COLOR INTERNAL AND EXTERNAL OF FURNITURE STRUCTURE - CABINET.

ON DEMAND BICOLOR WITH THE SAME FINISH
PRICE LIST WITH INCREASE FOR THE CHOICE FINISH

ON DEMAND BICOLOR WITH TWO DIFFERENT FINISHES
PRICE LIST WITH INCREASE CALCULATED ON THE HIGHER INCREASE CHOSEN FINISH

UNDERTOP WASHBASIN		OVERTOP WASHBASIN	
8 LA 63 WHITE		13 LA 64 BLACK	27 FOGLIA Similgold LA 50
internal 36,5x51,5 external 41x56		internal 38 external 40	

PEREMPORY WITH MARBLE TOP LA 63 - LA 64
INSTALL SIPHON WITH OVERALL LESS THAN CM. 9

CORE

for one or two undertop - overtop washbasin

<p>108</p> <p>Increase friezes foglia OR/AE 5</p> <p>MO 272 L 106 P 58/41 H 82 one big drawer</p>	<p>135</p> <p>Increase friezes foglia OR/AE 7</p> <p>MO 295 L 106 P 58/41 H 82 three doors two drawers</p>	<p>165</p> <p>Increase friezes foglia OR/AE 9</p> <p>MO 296 L 106 P 58/41 H 82 one big drawer six drawers</p>	<p>146</p> <p>Increase friezes foglia OR/AE 8</p> <p>MO 289 L 106 P 58/41 H 82 one big drawer four draws</p>
<p>295</p> <p>Increase friezes foglia OR/AE 11</p> <p>MO 298 L 174 P 58/41 H 82 four doors one basket two drawers</p>		<p>310</p> <p>Increase friezes foglia OR/AE 12</p> <p>MO 299 L 189 P 58/41 H 82 two big drawers one basket six drawers</p>	

CERAMIC TOP

except of CORE MO 272

54

POCER59
L 110 P 61 H 4

CRYSTAL TOP

with washbasin INCREASE +10% WAVE MANUFACTURE -
OPTIONAL linear riser h 4 cm linear meter 10 or shaped riser h 10 cm linear meter 15

71

POCRI60
L 105 P 59/42 H 1,5

123

POCRI61
L 173 P 59/42 H 1,5

129

POCRI62
L 189 P 59/41 H 1,5

MARBLE TOP

for one or two undertop - overtop washbasin INCREASE +25% THICKNESS CM.3

POMA109 undertop
POMA209 overtop
L 107 P 60/43 H 2

- | | |
|----|----|
| C1 | 33 |
| C2 | 41 |
| C3 | 51 |
| C4 | 56 |
| C5 | 62 |

POMA100 undertop
POMA200 overtop
L 175 P 60/43 H 2

- | | |
|----|-----|
| C1 | 54 |
| C2 | 67 |
| C3 | 82 |
| C4 | 89 |
| C5 | 100 |

POMA101 undertop
POMA201 overtop
L 192 P 60/43 H 2

- | | |
|----|-----|
| C1 | 58 |
| C2 | 72 |
| C3 | 88 |
| C4 | 96 |
| C5 | 108 |

MIRRORS

Increase friezes foglia OR/AE 4

37

SP 291
L 95 H 70

40

SP 292
L 95 H 95

60

SP 2550
L 93/82 H 90

ACCESSORIES

Increase friezes foglia OR/AE 5

130
VT 299 Sx-Dx
L 53 P 41 H 178
**two doors
one drawer**

STANDARD FRIEZES SAME COLOR AND FINISH OF FURNITURE - MIRROR-CABINET
EXCLUDE NOCE DORATO - ROSSO MODENA - NERO FUMO -FOGLIA E FOGLIA PATINATA **A PRICE LIST**

ON DEMAND FRIEZE FOGLIA AVAILABLE FOR ALL FINISHES **WITH INCREASE**

FREGI

MY

LINDEN WOOD

INTERNAL BOTTOM DRAWER - BIG DRAWER AND DOOR 'S' COATING

STANDARD LACE AND ECO-LEATHER CORD SAME AS HANDLES **OR/CO/BR**

ON DEMAND CHOOSE COLOR LACE OR ECOLEATHER AND CORD ECOLEATHER **A PRICE LIST**

MAKEUP CORE central

108

Increase friezes foglia OR/AE 5

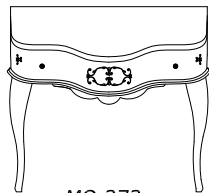

MO 273
L 106 P 58/41 H 82
one big drawer

70

Increase friezes foglia OR/AE 2

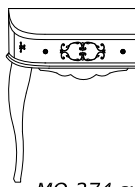

MO 274 sx
L 76 P 35 H 83
one big drawer

MAKEUP CORE

match it with cores or
makeup core central

70

Increase friezes foglia OR/AE 2

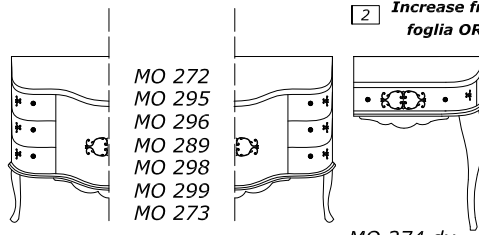

MO 274 dx
L 76 P 35 H 83
one big drawer

MO 272
MO 295
MO 296
MO 289
MO 298
MO 299
MO 273

WOOD TOP

30



POLEG2315
L 107 P 60/43 H 2

42



POCRI65
L 106 P 59/42 H 1,5

CRYSTAL TOP

INCREASE +10% WAVE MANUFACTURE -
OPTIONAL linear riser h 4 cm linear meter 10 or shaped rider h 10 cm linear meter 15 MAX LENGTH 2,25ml

23

add to matched core's POCRI



POCRI66 dx/sx
L 77 P 37 H 1,5

MARBLE TOP

INCREASE +25% THICKNESS CM.3 MAX LENGTH L 2,25 ml

add to matched core's POMA

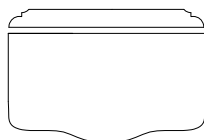

POMA108
L 107 P 60/43 H 2

C1 29
C2 37
C3 47
C4 52
C5 58



POMA113 dx/sx
L 77 P 37 H 2

C1 20
C2 25
C3 32
C4 35
C5 40

MIRRORS

Increase friezes foglia OR/AE 4

Increase friezes foglia OR/AE 4

Increase friezes foglia OR/AE 4

Increase friezes foglia OR/AE 5

49

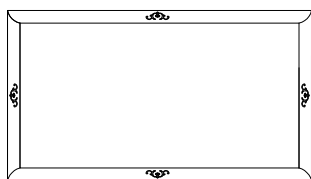

SP 293
L 170 H 95

85

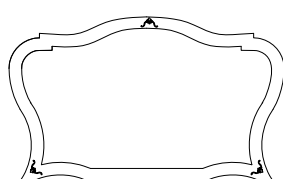

SP 2552
L 150/140 H 90

49

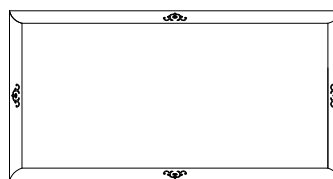

SP 294
L 185 H 95

110

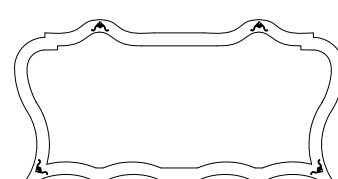

SP 2553
L 180/168 H 90

ACCESSORIES

Increase friezes foglia OR/AE 10

254

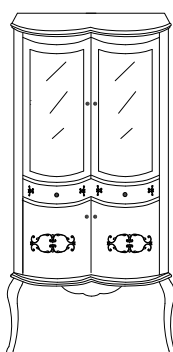

VT 298
L 94 P 42 H 178
**four doors
one drawer**

33

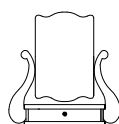

CD 94
L 68 P 20 H 60
**PETTINEUSE
one drawer**

43



CD 74
L 43 P 43 H 46
**pouf seat
ecoleather smooth**

48

Aumento per swarovski 6



CD 75
L 43 P 43 H 46
**pouf seat
ecoleather capitonné**

**FINISH'S INCREASE
ONECOLOR-BICOLOR**

NERO F.-ROSSO M.-NOCE D.	PRICE LIST
ANTICATO 21 colors	PRICE LIST
PATINATO 21 colors	PRICE LIST
ANTICATO 4 metals	10%
PATINATO 4 metals	10%
LACCATO 21 colors	10%
BRILLANTE 21 colors	20%
MADREPERLA 21 colors	20%
FOGLIA oro/argento	10%
FOGLIA PATINATA oro/arg	10%

INTARSIO FREGI

Knob Q

IMPORTANT
COMPATIBLE WITH
WASHBASIN OF MAX SIZE
LA 63 - LA 64

STANDARD FRIEZES IN FOGLIA GOLD/SILVER A PRICE LIST

UNDERTOP WASHBASIN		OVERTOP WASHBASIN	
8 LA 63 WHITE		13 LA 64 BLACK	
internal 36,5x51,5 external 41x56		internal 38 external 40	

PEREMPTORY WITH MARBLE TOP LA 63 - LA 64
INSTALL SIPHON WITH OVERALL LESS THAN CM. 9

CORE

for one or two undertop - overtop washbasin

146



MO 2430
L 130/110 P 64 H 83
one big drawer

229

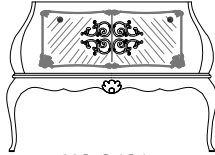

MO 2431
L 132/119 P 56 H 83
one big drawer

302

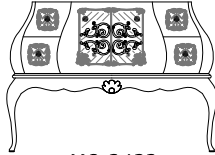

MO 2432
L 132/119 P 56 H 83
one big drawer
four drawers

275

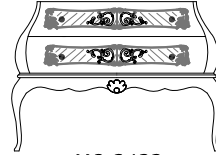

MO 2433
L 132/119 P 56 H 83
two big drawers

403

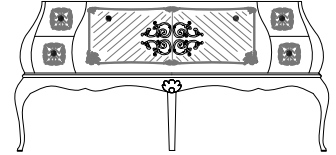

MO 2434 one washbasin
L 185/172 P 63 H 83
one big drawer
four drawers

375

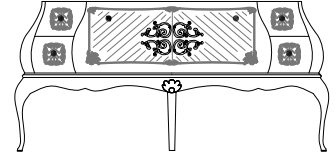

MO 2435 two washbasins
L 185/172 P 63 H 83
one big drawer
two drawers

CRYSTAL TOP

with washbasin INCREASE +10% WAVE MANUFACTURE - OPTIONAL linear riser h 4 cm linear meter 10 or shaped riser h 10 cm linear meter 15

80

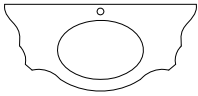

POCRI93
L 133/113 P 66 H 1,5

76

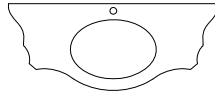

POCRI90
L 121/89 P 57 H 1,5

97

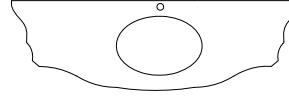

POCRI91
L 174/146 P 65 H 1,5

123

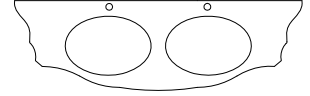

POCRI92
L 174/146 P 65 H 1,5

MARBLE TOP

for one or two undertop - overtop washbasin INCREASE +25% THICKNESS CM.3

POMA175 undertop
POMA275 overtop
L 135/115 P 67 H 2

- C1 39
- C2 48
- C3 59
- C4 65
- C5 73

POMA176 undertop
POMA276 overtop
L 135/115 P 67 H 2

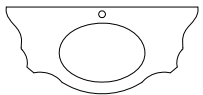

POMA160 undertop
POMA260 overtop
L 123/91 P 58 H 2

- C1 35
- C2 44
- C3 54
- C4 59
- C5 66

POMA120 undertop
POMA220 overtop
L 123/91 P 58 H 2

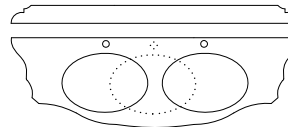
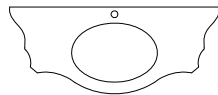

POMA161 for 1 undertop
POMA261 for 1 overtop
POMA162 for 2 undertop
POMA262 for 2 overtop
L 177/148 P 65 H 2

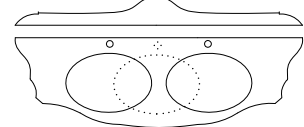

POMA184 for 1 undertop
POMA284 for 1 overtop
POMA186 for 2 undertop
POMA286 for 2 overtop
L 177/148 P 65 H 2

- C1 52
- C2 64
- C3 79
- C4 87
- C5 97

MIRRORS

56

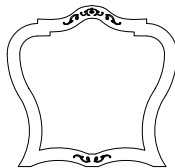

SP 2430
L 93/82 H 90

89

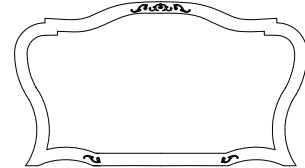

SP 2431
L 150/140 H 90

ACCESSORIES

219

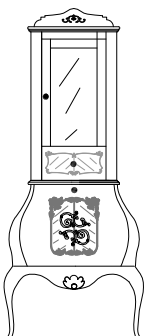

VT 2430 Sx-Dx
L 70/53 P 38 H 180
one door
one drawer
one big drawer

400

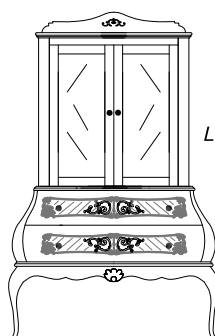

VT 2431
L 132/110 P 38 H 180
two doors
two big drawers

275

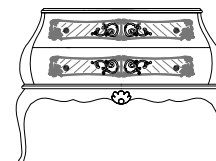

VT 2432
L 132/110 P 38 H 85
two big drawers

130

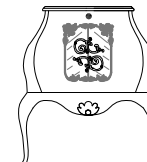

VT 2433
L 70/53 P 38 H 85
one big drawer

INTERNAL BOTTOM DRAWER - BIG DRAWER AND DOOR 'S COATING
STANDARD LACE AND ECO-LEATHER CORD SAME AS HANDLES OR/CO/BR
ON DEMAND CHOOSE COLOR LACE OR ECOLEATHER AND CORD ECOLEATHER A PRICE LIST

MAKEUP CORE central

MAKEUP CORE
match it with cores or
makeup core central

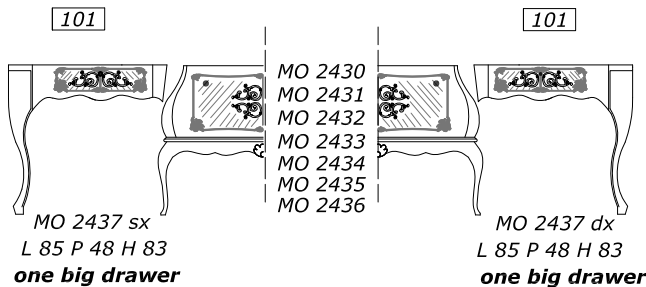
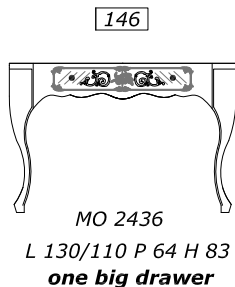

WOOD TOP

CRYSTAL TOP

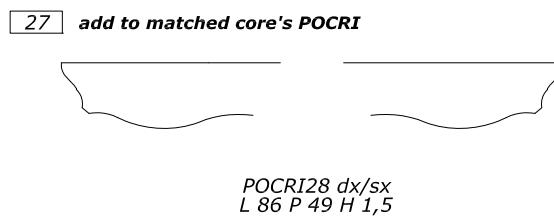
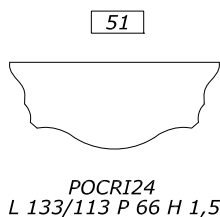
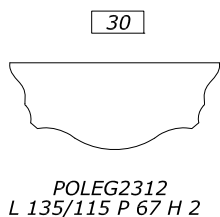

MARBLE TOP

INCREASE +25% THICKNESS CM.3 MAX LENGTH L 2,25 ml

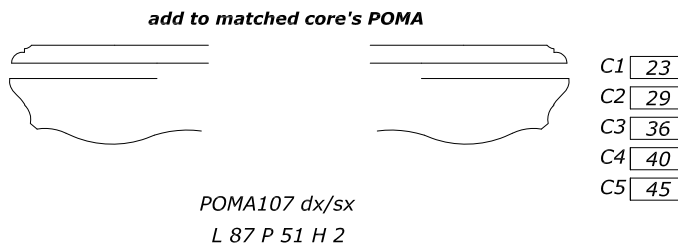
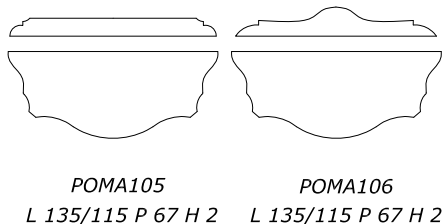

MIRRORS

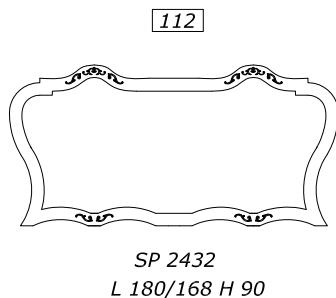

ACCESSORIES

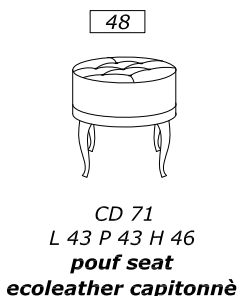
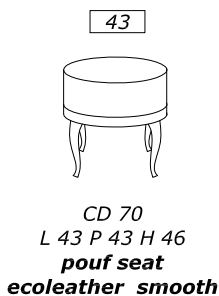
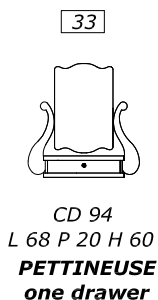

FINISH'S INCREASE

ROSSO M. - NOCE D. PRICE LIST

Knob Q

IMPORTANT
COMPATIBLE WITH
WASHBASIN OF MAX SIZE
LA 63 - LA 64

STANDARD FRIEZES IN FOGLIA GOLD/SILVER A PRICE LIST

UNDERTOP WASHBASIN [8] LA 63 WHITE [13] LA 64 BLACK internal 36,5x51,5 external 41x56		OVERTOP WASHBASIN [27] FOGLIA Simlgold LA 50 [27] FOGLIA Similsilver LA 51 LA 52 internal 38 external 40	
---	--	--	--

PEREMPORY WITH MARBLE TOP LA 63 - LA 64
INSTALL SIPHON WITH OVERALL LESS THAN CM. 9

CORE

for one or two undertop - overtop washbasin

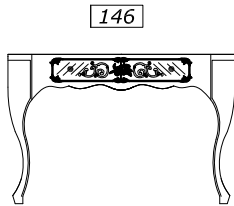

MO 2430
L 130/110 P 64 H 83
one big drawer

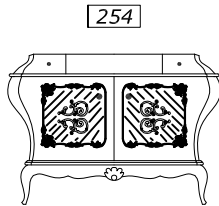

MO 2445
L 132/110 P 60 H 82
**two doors
two drawers**

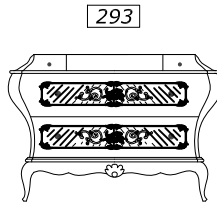

MO 2446
L 132/110 P 60 H 82
**two big drawers
two drawers**

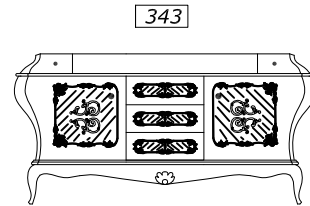

MO 2447
L 176/152 P 60 H 82
**two doors
three drawers**

CRYSTAL TOP

with washbasin INCREASE +10% WAVE MANUFACTURE - OPTIONAL linear riser h 4 cm linear meter [10] or shaped riser h 10 cm linear meter [15]

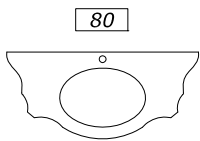

POCRI93
L 133/115 P 66 H 1,5

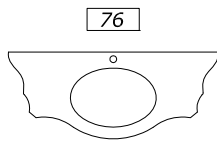

POCRI40
L 123/104 P 59 H 1,5

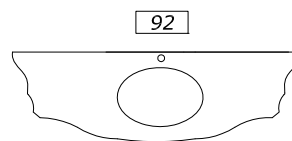

POCRI41
L 166/148 P 59 H 1,5

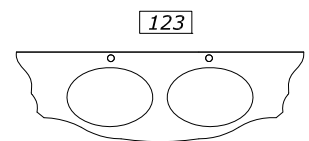

POCRI42
L 166/148 P 59 H 1,5

MARBLE TOP

for one or two undertop - overtop washbasin INCREASE +25% THICKNESS CM.3

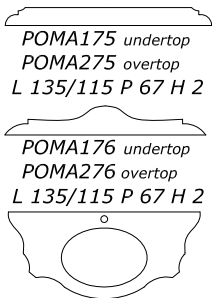

POMA175 undertop
POMA275 overtop
L 135/115 P 67 H 2

- C1 [39]
- C2 [48]
- C3 [59]
- C4 [65]
- C5 [73]

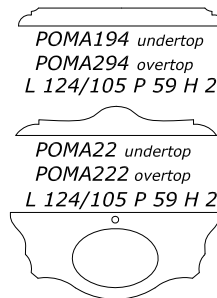

POMA194 undertop
POMA294 overtop
L 124/105 P 59 H 2

- C1 [36]
- C2 [45]
- C3 [56]
- C4 [61]
- C5 [68]

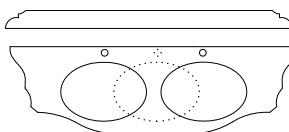

POMA195 for 1 undertop
POMA295 for 1 overtop
POMA196 for 2 undertops
POMA296 for 2 overtops
L 167/149 P 59 H 2

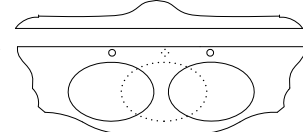

POMA12 for 1 undertop
POMA212 for 1 overtop
POMA63 for 2 undertops
POMA263 for 2 overtops
L 167/149 P 59 H 2

- C1 [50]
- C2 [62]
- C3 [76]
- C4 [83]
- C5 [93]

MIRRORS

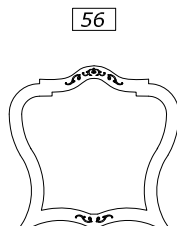

SP 2430
L 93/82 H 90

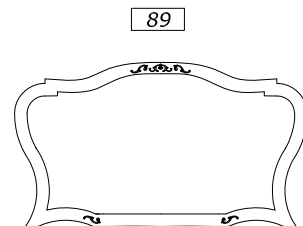

SP 2431
L 150/140 H 90

ACCESSORIES

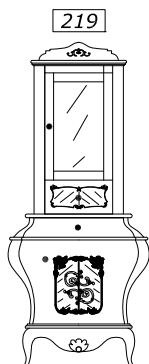

VT 2445 Sx-Dx
L 71/53 P 38 H 180
**two doors
two drawers**

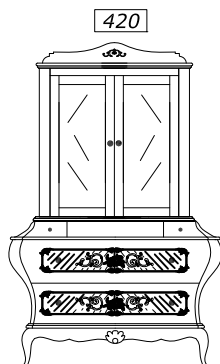

VT 2446
L 132/110 P 38 H 180
**two doors
two drawers
two big drawers**

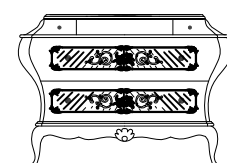

VT 2447
L 132/110 P 38 H 85
**two big drawers
two drawers**



VT 2448 Sx-Dx
L 71/53 P 38 H 85
**one door
one drawer**

INTERNAL BOTTOM DRAWER - BIG DRAWER AND DOOR 'S COATING

STANDARD LACE AND ECO-LEATHER CORD SAME AS HANDLES OR/CO/BR

ON DEMAND CHOOSE COLOR LACE OR ECOLEATHER AND CORD ECOLEATHER A PRICE LIST

MAKEUP CORE central

MAKEUP CORE
match it with cores or
makeup core central

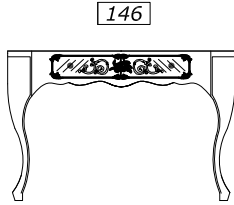

MO 2436
L 130/110 P 64 H 83
one big drawer

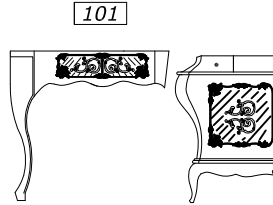

MO 2437 sx
L 85 P 48 H 83
one big drawer

MO 2430
MO 2445
MO 2446
MO 2447
MO 2436

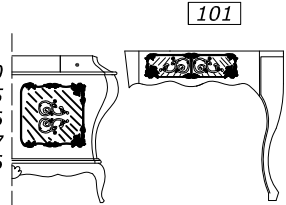

MO 2437 dx
L 85 P 48 H 83
one big drawer

WOOD TOP

CRYSTAL TOP

INCREASE +10% WAVE MANUFACTURE -

OPTIONAL linear riser h 4 cm linear meter 10 or shaped rider h 10 cm linear meter 15 MAX LENGTH 2,25ml

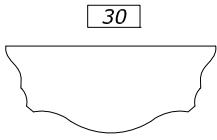

POLEG2312
L 135/115 P 67 H 2

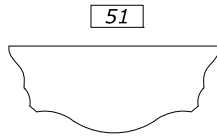

POCRI24
L 133/113 P 66 H 1,5



POCRI28 dx/sx
L 86 P 49 H 1,5

add to matched core's POCRI

MARBLE TOP

INCREASE +25% THICKNESS CM.3 MAX LENGTH L 2,25 ml

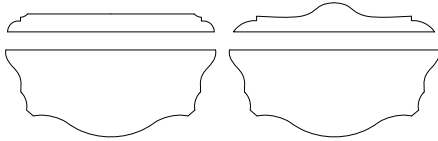

POMA105 L 135/115 P 67 H 2
POMA106 L 135/115 P 67 H 2

- C1 35
- C2 45
- C3 56
- C4 62
- C5 69

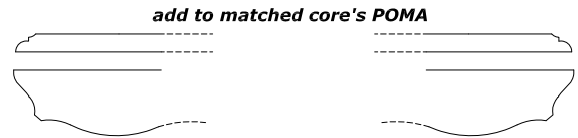

POMA107 dx/sx
L 87 P 51 H 2

add to matched core's POMA

- C1 23
- C2 29
- C3 36
- C4 40
- C5 45

MIRRORS

112

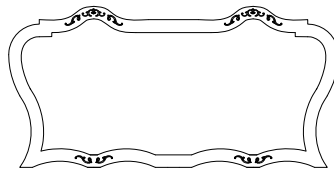

SP 2432
L 180/168 H 90

ACCESSORIES

FINISH'S INCREASE

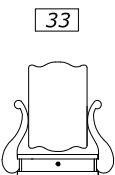

CD 94
L 68 P 20 H 60
PETTINEUSE
one drawer



CD 70
L 43 P 43 H 46
pouf seat
ecoleather smooth



CD 71
L 43 P 43 H 46
pouf seat
ecoleather capitonné

increase for swarovski 6

ROSSO M. - NOCE D. PRICE LIST

Knob Q

IMPORTANT
COMPATIBLE WITH
WASHBASIN OF MAX SIZE
LA 63 - LA 64

STANDARD FRIEZES IN FOGLIA GOLD/SILVER A PRICE LIST

UNDERTOP WASHBASIN [8] LA 63 WHITE internal 36,5x51,5		OVERTOP WASHBASIN [13] LA 64 BLACK internal 41x56	
[27] FOGLIA Simitgold LA 50		[27] FOGLIA Simitilver LA 51 LA 52 internal 38 external 40	

PEREMPORY WITH MARBLE TOP LA 63 - LA 64
INSTALL SIPHON WITH OVERALL LESS THAN CM. 9

CORE

for one undertop - overtop washbasin

[196]

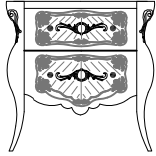

MO 2410
L 90/72 P 58 H 83
two big drawers

[141]

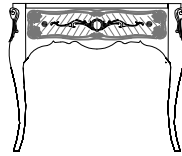

MO 2411
L 115/95 P 58 H 83
one big drawer

[205]

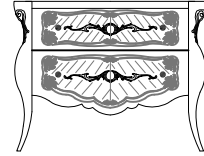

MO 2412
L 115/95 P 58 H 83
two big drawers

CRYSTAL TOP

with washbasin INCREASE +10% WAVE MANUFACTURE - OPTIONAL linear riser h 4 cm linear meter [10] or shaped riser h 10 cm linear meter [15]

[57]

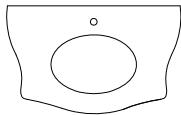

POCRI15
L 89/75 P 58 H 1,5

[74]

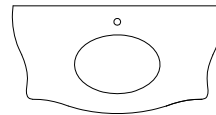

POCRI43
L 113/99 P 58 H 1,5

MARBLE TOP

for one undertop - overtop washbasin INCREASE +25% THICKNESS CM.3

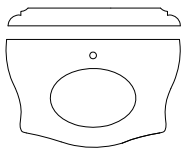

POMA118 undertop
POMA218 overtop
L 91/77 P 59 H 2

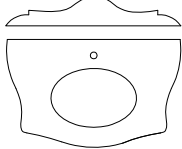

POMA119 undertop
POMA219 overtop
L 91/77 P 59 H 2

- C1 [27]
- C2 [33]
- C3 [41]
- C4 [45]
- C5 [50]

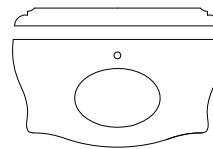

POMA139 undertop
POMA239 overtop
L 116/100 P 59 H 2

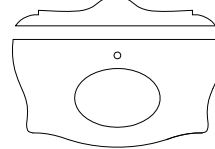

POMA24 undertop
POMA224 overtop
L 116/100 P 59 H 2

- C1 [35]
- C2 [44]
- C3 [53]
- C4 [59]
- C5 [66]

MIRRORS

[50]

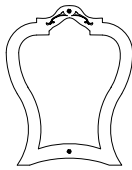

SP 2410
L 71/60 H 90

[54]

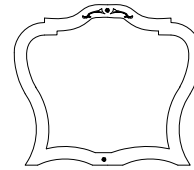

SP 2411
L 93/82 H 90

ACCESSORIES

[211]



VT 2410 Sx-Dx
L 65/53 P 38 H 180
**two doors
one drawer**

[334]

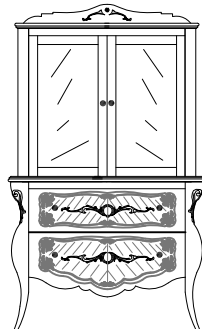

VT 2414
L 106/100 P 41 H 180
**two doors
two big drawers**

[209]

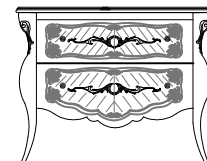

VT 2413
L 106/100 P 41 H 85
two big drawers

[128]

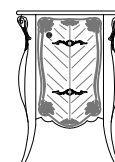

VT 2411 Sx-Dx
L 65/53 P 38 H 85
one door

INTERNAL BOTTOM DRAWER - BIG DRAWER AND DOOR 'S COATING
STANDARD LACE AND ECO-LEATHER CORD SAME AS HANDLES OR/CO/BR
ON DEMAND CHOOSE COLOR LACE OR ECOLEATHER AND CORD ECOLEATHER A PRICE LIST

MAKEUP CORE central

MAKEUP CORE
match it with cores or
makeup core central

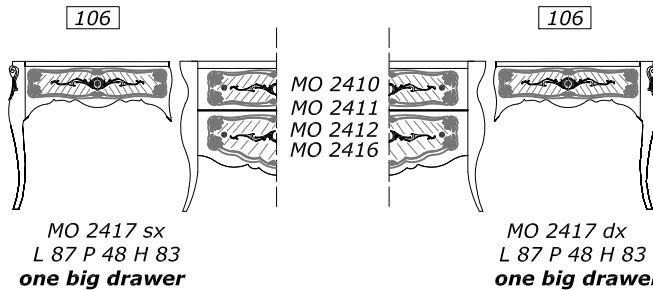
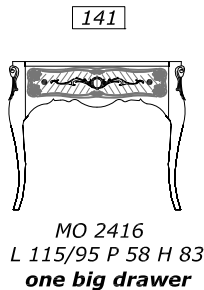

WOOD TOP

CRYSTAL TOP

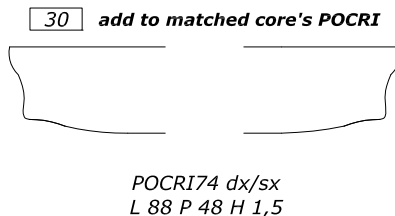
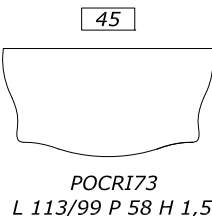
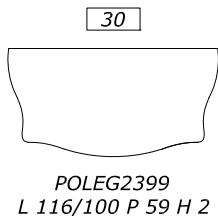

INCREASE +10% WAVE MANUFACTURE -
OPTIONAL linear riser h 4 cm linear meter 10 or shaped rider h 10 cm linear meter 15 MAX LENGTH 2,25ml

MARBLE TOP

INCREASE +25% THICKNESS CM.3 MAX LENGTH L 2,25 ml
add to matched core's POMA

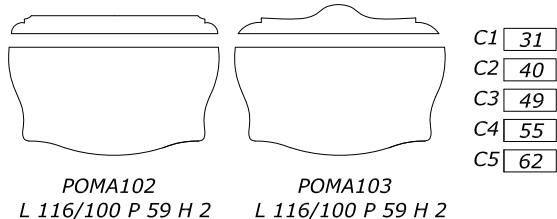

MIRRORS

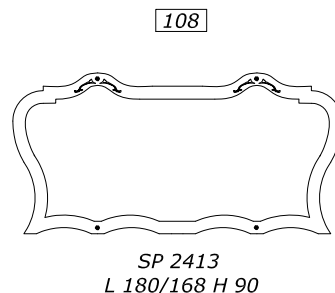
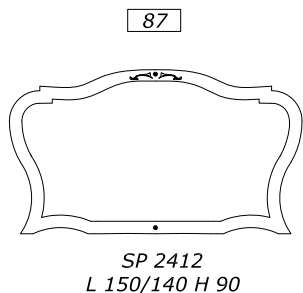

ACCESSORIES

FINISH'S INCREASE

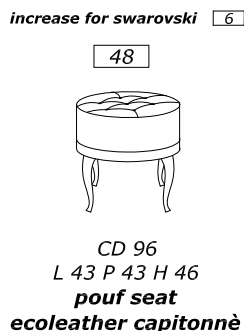
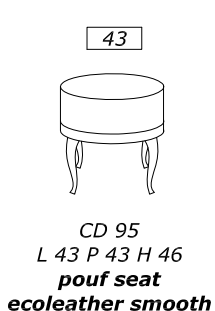
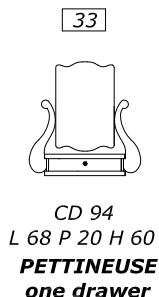

ROSSO M. - NOCE D. PRICE LIST

Knob Q

IMPORTANT
COMPATIBLE WITH
WASHBASIN OF MAX SIZE
LA 63 - LA 64

STANDARD FRIEZES IN FOGLIA GOLD/SILVER A PRICE LIST

UNDERTOP WASHBASIN 8 LA 63 WHITE 13 LA 64 BLACK internal 36,5x51,5 external 41x56		OVERTOP WASHBASIN 27 FOGLIA Similgold LA 50 27 FOGLIA Similsilver LA 51 LA 52 internal 38 external 40	
--	--	--	--

PEREMPORY WITH MARBLE TOP LA 63 - LA 64
INSTALL SIPHON WITH OVERALL LESS THAN CM. 9

CORE

for one or two undertop - overtop washbasin

264

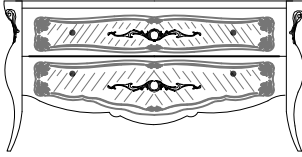

MO 2413
L 173/153 P 58 H 83
two big drawers

349

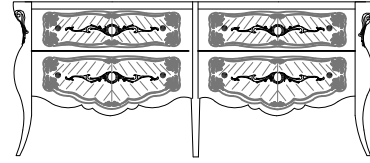

MO 2414
L 203/182 P 58 H 83
four big drawers

CRYSTAL TOP

with washbasin INCREASE +10% WAVE MANUFACTURE - OPTIONAL linear riser h 4 cm linear meter 10 or shaped riser h 10 cm linear meter 15

92

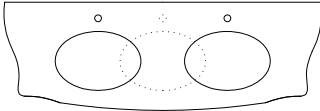

POCRI44 for 1 washbasin
L 172/156 P 58 H 1,5

123

POCRI45 for 2 washbasins
L 172/156 P 58 H 1,5

137

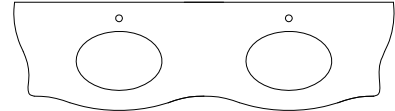

POCRI46
L 200/185 P 58 H 1,5

MARBLE TOP

for one or two undertop - overtop washbasin INCREASE +25% THICKNESS CM.3

POMA116 one undertop

POMA115 two undertops

POMA216 one overtop

POMA215 two overtops

L 173/157 P 59 H 2

- C1 51
- C2 63
- C3 79
- C4 86
- C5 97

POMA117 undertop

POMA217 overtop

L 202/186 P 59 H 2

- C1 62
- C2 76
- C3 94
- C4 103
- C5 115

POMA04 one undertop

POMA02 two undertops

POMA204 one overtop

POMA202 two overtops

L 173/157 P 59 H 2

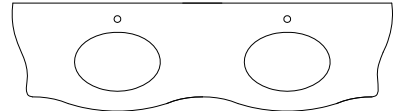
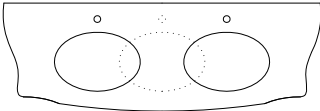

MIRRORS

87

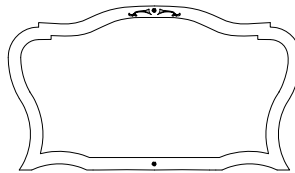

SP 2412
L 150/140 H 90

ACCESSORIES

211

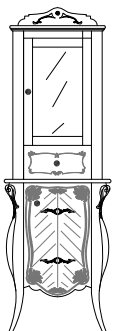

VT 2410 Sx-Dx
L 65/53 P 38 H 180
two doors
one drawer

334

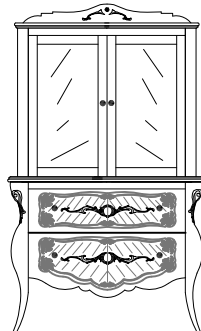

VT 2414
L 106/100 P 41 H 180
two doors
two big drawers

209

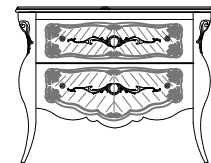

VT 2413
L 106/100 P 41 H 85
two big drawers

128

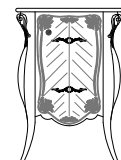

VT 2411 Sx-Dx
L 65/53 P 38 H 85
one door

INTERNAL BOTTOM DRAWER - BIG DRAWER AND DOOR 'S COATING
STANDARD LACE AND ECO-LEATHER CORD SAME AS HANDLES OR/CO/BR
ON DEMAND CHOOSE COLOR LACE OR ECOLEATHER AND CORD ECOLEATHER A PRICE LIST

MAKEUP CORE central

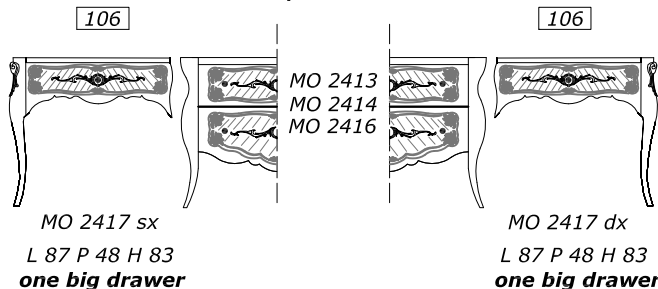

WOOD TOP

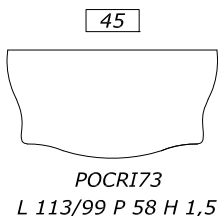
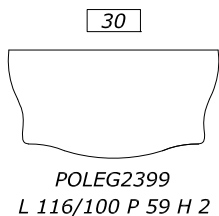

CRYSTAL TOP

INCREASE +10% WAVE MANUFACTURE -
OPTIONAL linear riser h 4 cm linear meter 10 or shaped rider h 10 cm linear meter 15 MAX LENGTH 2,25ml

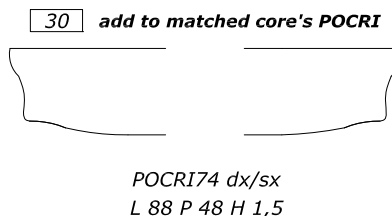

MARBLE TOP

INCREASE +25% THICKNESS CM.3 MAX LENGTH L 2,25 ml

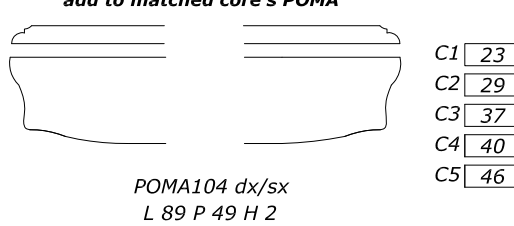
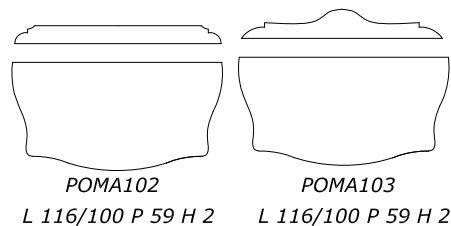

MIRRORS

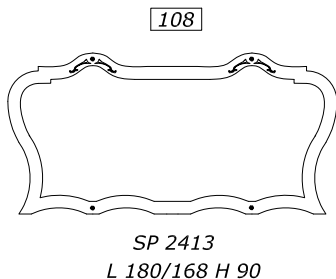

ACCESSORIES

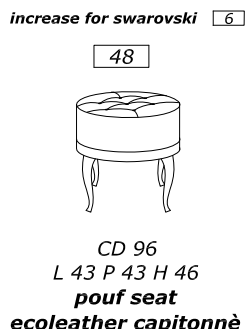
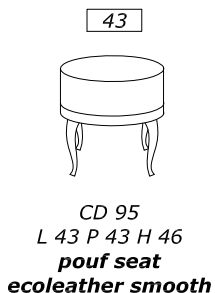
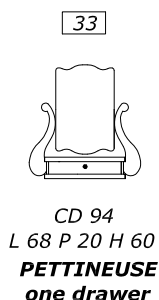

FINISH'S INCREASE

ROSSO M. - NOCE D.	PRICE LIST

Knob Q

IMPORTANT
COMPATIBLE WITH
WASHBASIN OF MAX SIZE
LA 63 - LA 64 - LA 03

STANDARD FRIEZES IN FOGLIA GOLD/SILVER **A PRICE LIST**

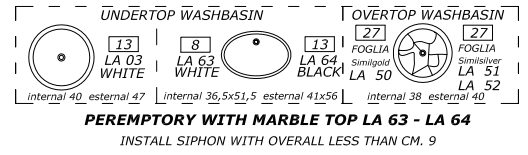

CORE

for one or two undertop - overtop washbasin

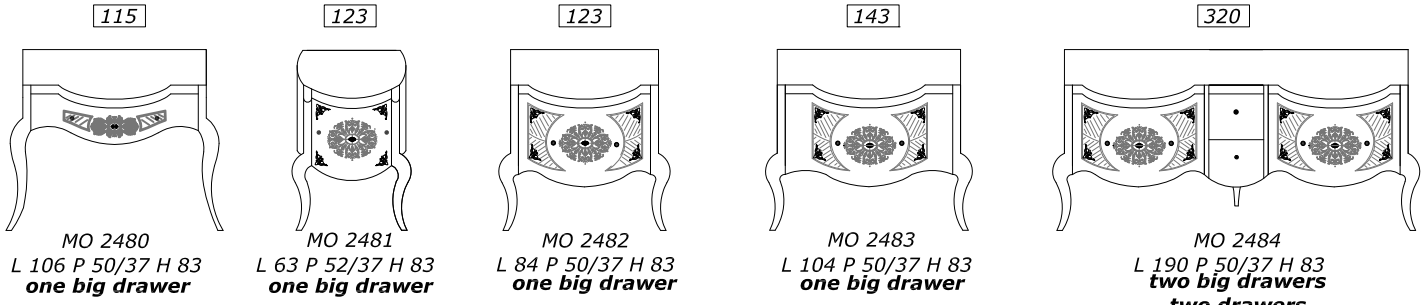

CERAMIC TOP

except of CORE MO 2480

CRYSTAL TOP

with washbasin INCREASE +10% WAVE MANUFACTURE -
OPTIONAL linear riser h 4 cm linear meter 10 or shaped riser h 10 cm linear meter 15

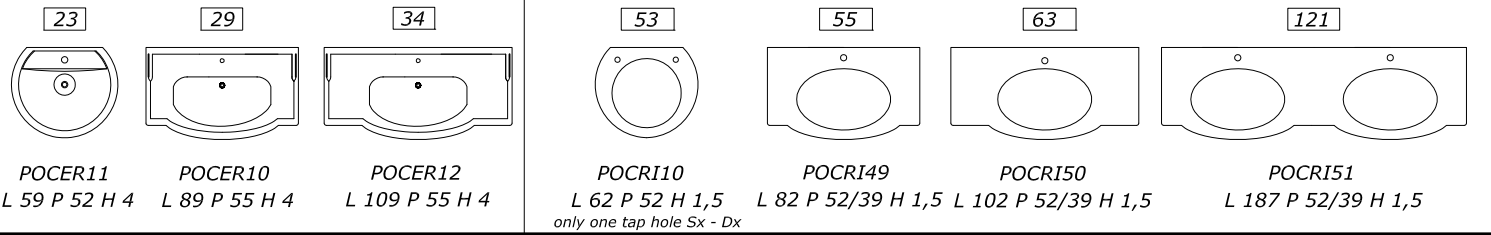

MARBLE TOP

for one or two undertop - overtop washbasin INCREASE +25% THICKNESS CM.3

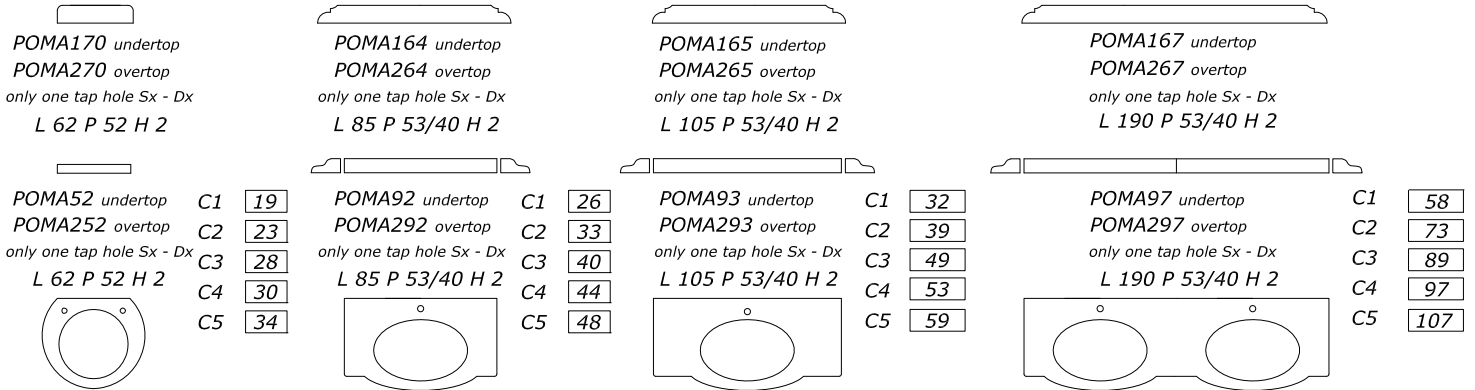

MIRRORS

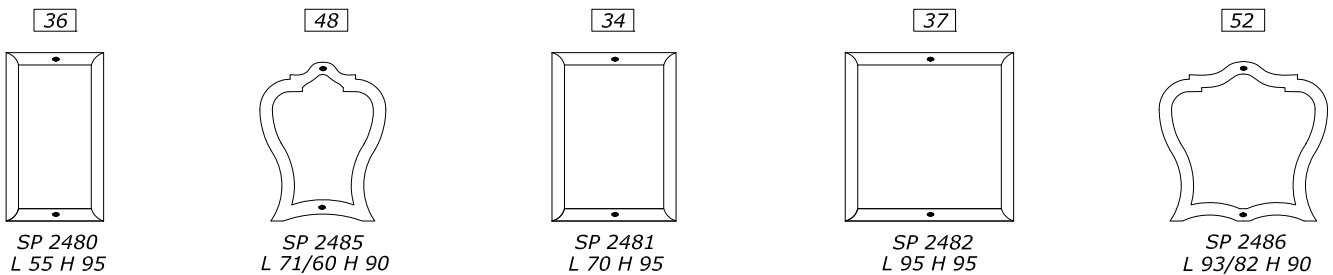

ACCESSORIES

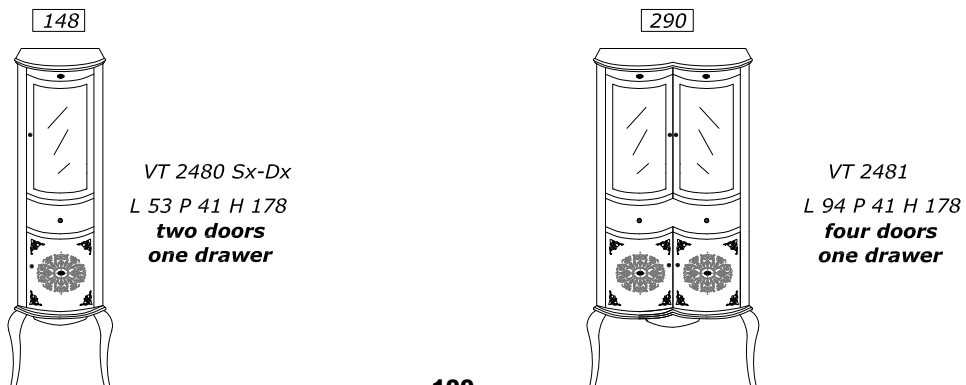

INTERNAL BOTTOM DRAWER - BIG DRAWER AND DOOR 'S COATING
STANDARD LACE AND ECO-LEATHER CORD SAME AS HANDLES OR/CO/BR
ON DEMAND CHOOSE COLOR LACE OR ECOLEATHER AND CORD ECOLEATHER A PRICE LIST

MAKEUP CORE central

MAKEUP CORE
match it with cores or
makeup core central

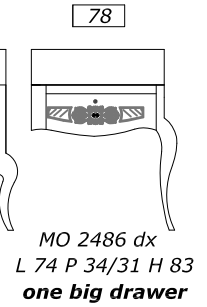
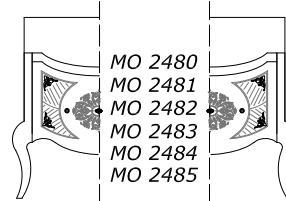
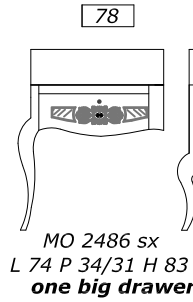
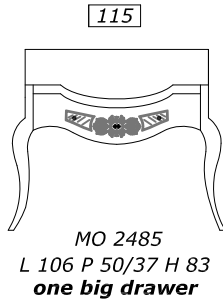

WOOD TOP

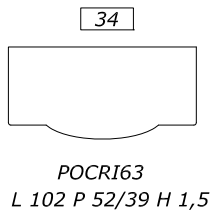
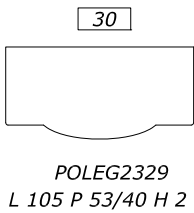

CRYSTAL TOP

INCREASE +10% WAVE MANUFACTURE -
OPTIONAL linear riser h 4 cm linear meter 10 or shaped rider h 10 cm linear meter 15 MAX LENGTH 2,25ml

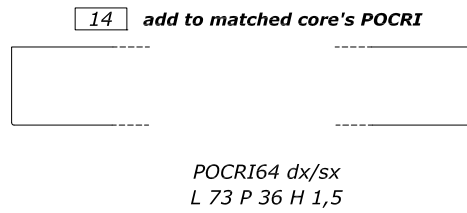

MARBLE TOP

INCREASE +25% THICKNESS CM.3 MAX LENGTH L 2,25 ml

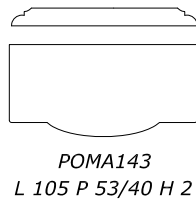

- C1 28
- C2 35
- C3 45
- C4 49
- C5 55

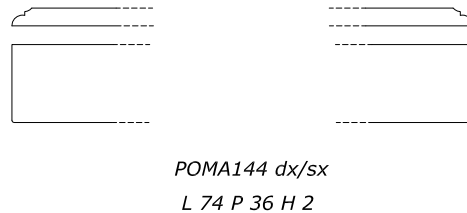

- C1 19
- C2 24
- C3 31
- C4 34
- C5 38

MIRRORS

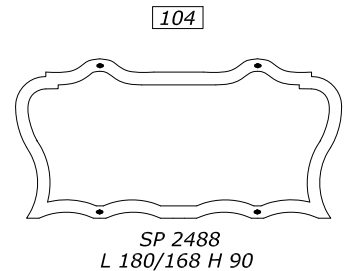
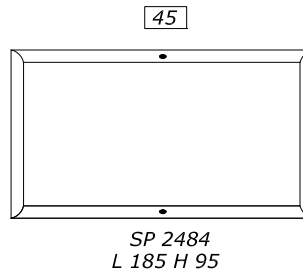
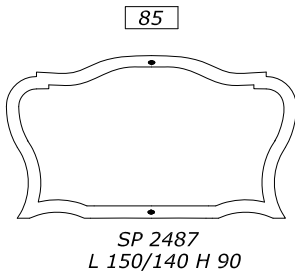
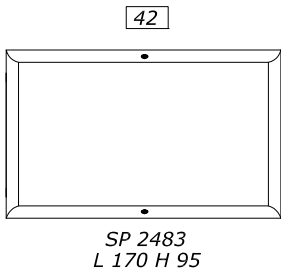

ACCESSORIES

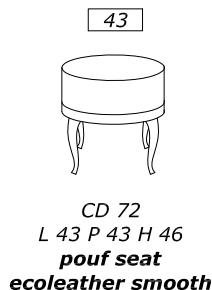
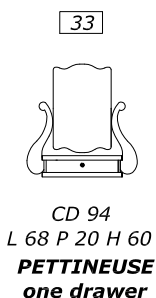

increase for swarovski 6

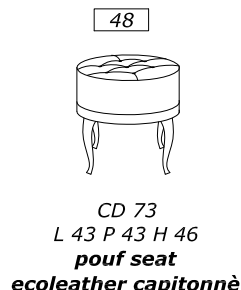

FINISH'S INCREASE

ROSSO M. - NOCE D. PRICE LIST

Knob Q

IMPORTANT
COMPATIBLE WITH
WASHBASIN OF MAX SIZE
LA 63 - LA 64

STANDARD FRIEZES IN FOGLIA GOLD/SILVER A PRICE LIST

UNDERTOP WASHBASIN		OVERTOP WASHBASIN	
8 LA 63 WHITE		13 LA 64 BLACK	
internal 36,5x51,5 external 41x56		internal 38 external 40	

PEREMPATORY WITH MARBLE TOP LA 63 - LA 64

INSTALL SIPHON WITH OVERALL LESS THAN CM. 9

CORE

for one or two undertop - overtop washbasin

121

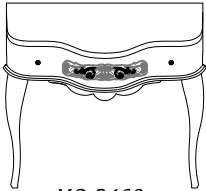

MO 2460
L 106 P 58/41 H 82
one big drawer

165

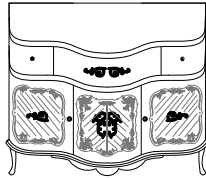

MO 2461
L 106 P 58/41 H 82
**three doors
two drawers**

171

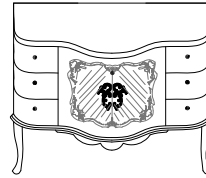

MO 2462
L 106 P 58/41 H 82
**one big drawer
six drawers**

153

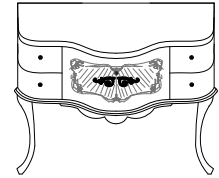

MO 2463
L 106 P 58/41 H 82
**one big drawer
four drawers**

335

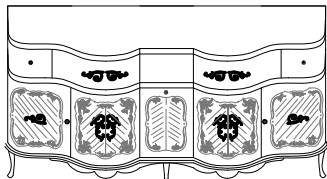

MO 2464
L 174 P 58/41 H 82
**four doors
one basket
two drawers**

318

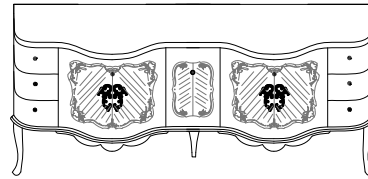

MO 2465
L 189 P 58/41 H 82
**two big drawers
one basket
six drawers**

CERAMIC TOP

except of CORE MO 2460

54

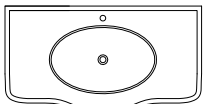

POCER59
L 110 P 61 H 4

71

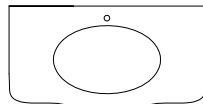

POCRI60
L 105 P 59/42 H 1,5

123

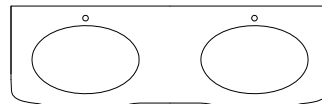

POCRI61
L 173 P 59/42 H 1,5

129

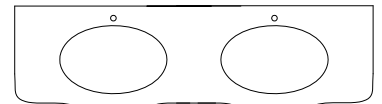

POCRI62
L 189 P 59/41 H 1,5

MARBLE TOP

for one or two undertop - overtop washbasin INCREASE +25% THICKNESS CM.3



POMA109 undertop
POMA209 overtop
L 107 P 60/43 H 2

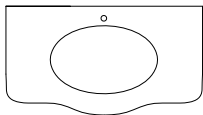

- C1 33
- C2 41
- C3 51
- C4 56
- C5 62



POMA100 undertop
POMA200 overtop
L 175 P 60/43 H 2

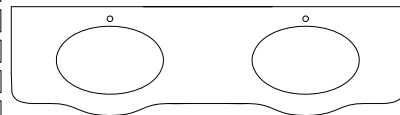

- C1 54
- C2 67
- C3 82
- C4 89
- C5 100



POMA101 undertop
POMA201 overtop
L 192 P 60/43 H 2

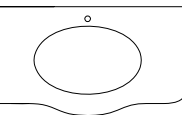

- C1 58
- C2 72
- C3 88
- C4 96
- C5 108

MIRRORS

42

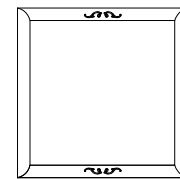

SP 2460
L 95 H 95

60

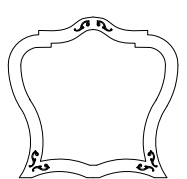

SP 2645
L 93/82 H 90

ACCESSORIES

140

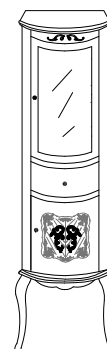

VT 2460 Sx-Dx
L 53 P 41 H 178
**two doors
one drawer**

INTERNAL BOTTOM DRAWER - BIG DRAWER AND DOOR 'S COATING
STANDARD LACE AND ECO-LEATHER CORD SAME AS HANDLES **OR/CO/BR**
ON DEMAND CHOOSE COLOR LACE OR ECOLEATHER AND CORD ECOLEATHER **A PRICE LIST**

MAKEUP CORE central

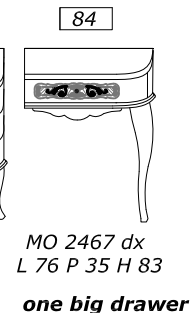
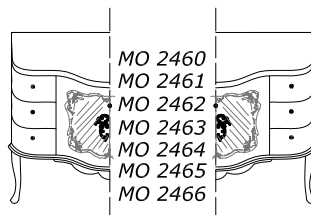
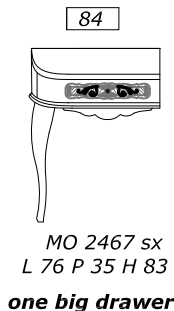
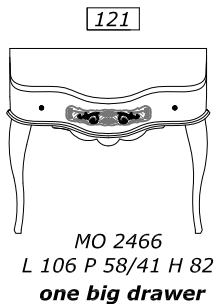

MAKEUP CORE

match it with cores or
makeup core central

WOOD TOP

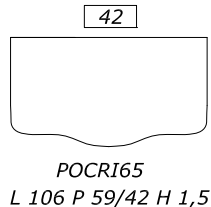
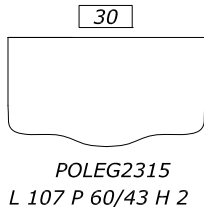

CRYSTAL TOP

INCREASE +10% WAVE MANUFACTURE -
OPTIONAL linear riser h 4 cm linear meter 10 or shaped rider h 10 cm linear meter 15 MAX LENGTH 2,25ml

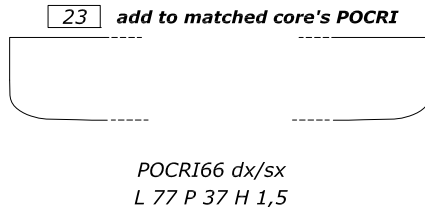

MARBLE TOP

INCREASE +25% THICKNESS CM.3 MAX LENGTH L 2,25 ml

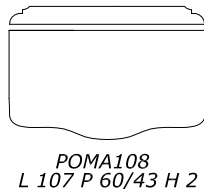

- C1 29
- C2 37
- C3 47
- C4 52
- C5 58

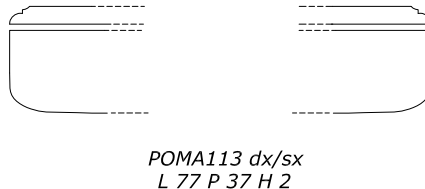

- C1 20
- C2 25
- C3 32
- C4 35
- C5 40

add to matched core's POMA

MIRRORS

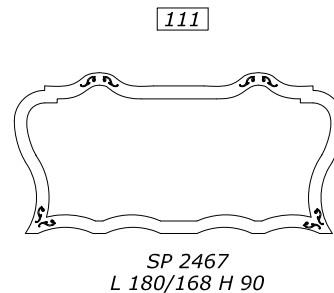
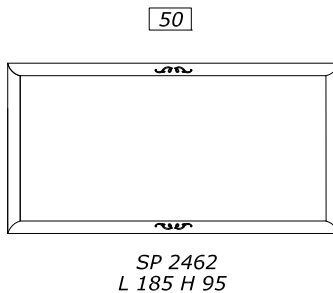
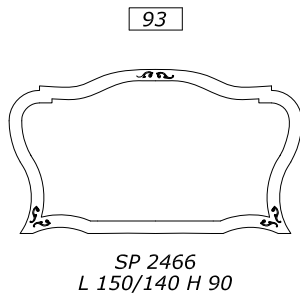
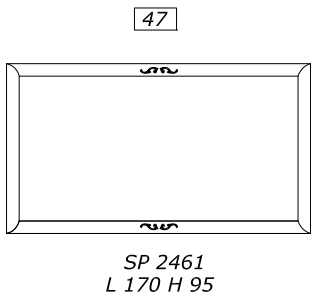

ACCESSORIES

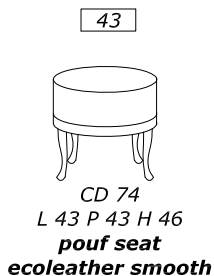
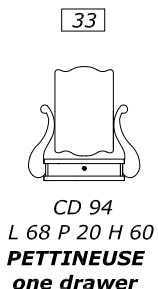
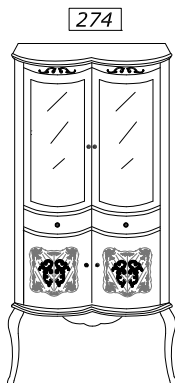

Aumento per swarovski 6

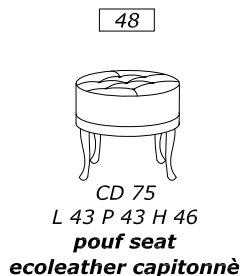

FINISH'S INCREASE

ROSSO M. - NOCE D. PRICE LIST

INTARSI O

Knob Q

IMPORTANT
COMPATIBLE WITH
WASHBASIN OF MAX SIZE
LA 63 - LA 64

INTARSIO FLOREALE ON THE FRONT OF CORES AND CABINETS

UNDERTOP WASHBASIN [8] LA 63 WHITE [13] LA 64 BLACK internal 36,5x51,5 external 41x56		OVERTOP WASHBASIN [27] FOGLIA Similgold LA 50 [27] FOGLIA Similsilver LA 51 LA 52 internal 38 external 40	
---	--	---	--

PEREMPORY WITH MARBLE TOP LA 63 - LA 64
INSTALL SIPHON WITH OVERALL LESS THAN CM. 9

CORE

for one or two undertop - overtop washbasin

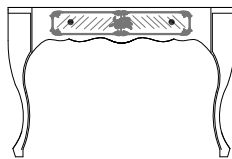
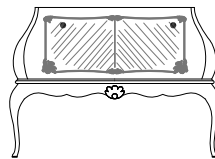
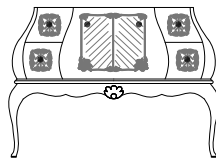
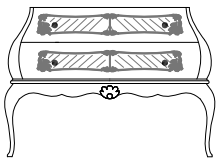
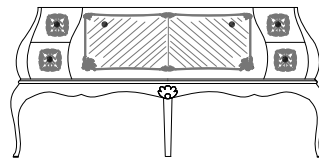
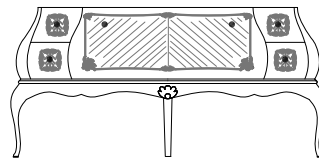
[137]  MO 2420 L 130/110 P 64 H 83 one big drawer	[211]  MO 2421 L 132/119 P 56 H 83 one big drawer	[284]  MO 2422 L 132/119 P 56 H 83 one big drawer four drawers	[257]  MO 2423 L 132/119 P 56 H 83 two big drawers	[385]  MO 2424 one washbasin L 185/172 P 63 H 83 one big drawer four drawers	[357]  MO 2425 two washbasins L 185/172 P 63 H 83 one big drawer two drawers
--	---	--	---	---	---

CRYSTAL TOP

with washbasin INCREASE +10% WAVE MANUFACTURE - OPTIONAL linear riser h 4 cm linear meter [10] or shaped riser h 10 cm linear meter [15]

[80]  POCRI93 L 133/113 P 66 H 1,5	[76]  POCRI90 L 121/89 P 57 H 1,5	[97]  POCRI91 L 174/146 P 65 H 1,5	[123]  POCRI92 L 174/146 P 65 H 1,5
---	---	---	---

MARBLE TOP

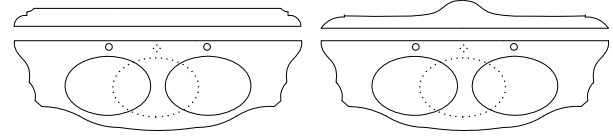
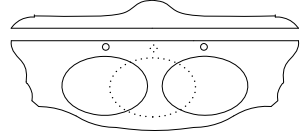

for one or two undertop - overtop washbasin INCREASE +25% THICKNESS CM.3

POMA175 undertop POMA275 overtop L 135/115 P 67 H 2 C1 [39] C2 [48] C3 [59] C4 [65] C5 [73]	POMA160 undertop POMA260 overtop L 123/91 P 58 H 2 C1 [35] C2 [44] C3 [54] C4 [59] C5 [66]	 POMA161 for 1 undertop POMA261 for 1 overtop POMA162 for 2 undertop POMA262 for 2 overtop L 177/148 P 65 H 2	 POMA184 for 1 undertop POMA284 for 1 overtop POMA186 for 2 undertop POMA286 for 2 overtop L 177/148 P 65 H 2 C1 [52] C2 [64] C3 [79] C4 [87] C5 [97]
--	---	---	---

MIRRORS

[50]  SP 250 L 93/82 H 90	[83]  SP 267 L 150/140 H 90
---	---

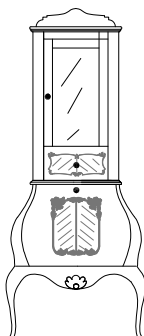
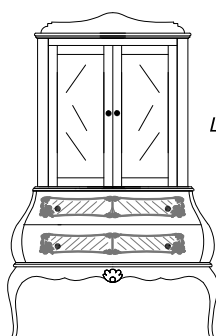
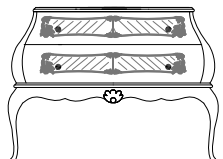
ACCESSORIES

[210]  VT 2420 Sx-Dx L 70/53 P 38 H 180 one door one drawer one big drawer	[382]  VT 2421 L 132/110 P 38 H 180 two doors two big drawers	[257]  VT 2422 L 132/110 P 38 H 85 two big drawers	[122]  VT 2423 L 70/53 P 38 H 85 one big drawer
---	---	--	---

INTERNAL BOTTOM DRAWER - BIG DRAWER AND DOOR 'S COATING
STANDARD LACE AND ECO-LEATHER CORD SAME AS HANDLES **OR/CO/BR**
ON DEMAND CHOOSE COLOR LACE OR ECOLEATHER AND CORD ECOLEATHER **A PRICE LIST**

MAKEUP CORE central

MAKEUP CORE
 match it with cores or
 makeup core central

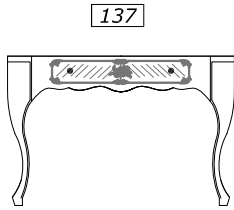

MO 2426
 L 130/110 P 64 H 83
 one big drawer

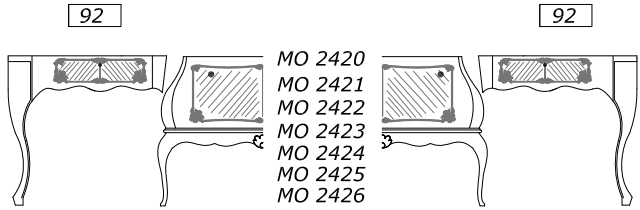

MO 2427 sx
 L 85 P 48 H 83
 one big drawer

- MO 2420
- MO 2421
- MO 2422
- MO 2423
- MO 2424
- MO 2425
- MO 2426

MO 2427 dx
 L 85 P 48 H 83
 one big drawer

WOOD TOP

CRYSTAL TOP

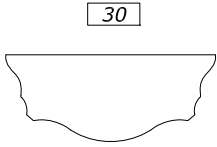

POLEG2312
 L 135/115 P 67 H 2

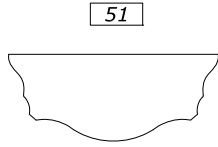

POCRI24
 L 133/113 P 66 H 1,5

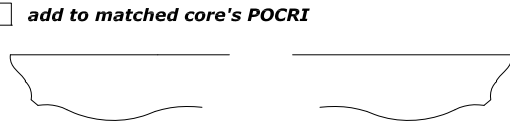

POCRI28 dx/sx
 L 86 P 49 H 1,5

increase +10% WAVE MANUFACTURE -
 OPTIONAL linear riser h4 cm l.m. 10 or raised shaped h 10 cm l.m. 15 MAX LENGTH 2,25ml

add to matched core's POCRI

MARBLE TOP

INCREASE +25% THICKNESS CM.3 MAX LENGTH L 2,25 ml

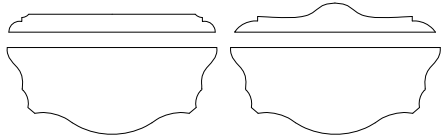

- C1 35
- C2 45
- C3 56
- C4 62
- C5 69

POMA105
 L 135/115 P 67 H 2

POMA106
 L 135/115 P 67 H 2



- C1 23
- C2 29
- C3 36
- C4 40
- C5 45

POMA107 dx/sx
 L 87 P 51 H 2

add to matched core's POMA

MIRRORS

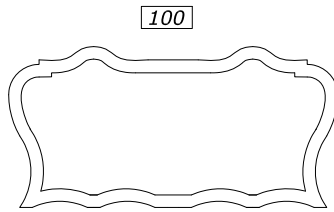

SP 263
 L 180/168 H 90

ACCESSORIES

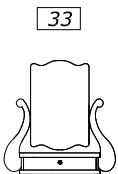

CD 94
 L 68 P 20 H 60
PETTINEUSE
 one drawer

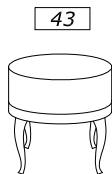

CD 70
 L 43 P 43 H 46
pouf seat
 ecoleather smooth



CD 71
 L 43 P 43 H 46
pouf seat
 ecoleather capitonnè

FINISH'S INCREASE

ROSSO M. - NOCE D. PRICE LIST

Knob Q

IMPORTANT
COMPATIBLE WITH
WASHBASIN OF MAX SIZE
LA 63 - LA 64

INTARSIO FLOREALE ON THE FRONT OF CORES AND CABINETS

UNDERTOP WASHBASIN [8] LA 63 WHITE internal 36,5x51,5		OVERTOP WASHBASIN [13] LA 64 BLACK external 41x56		[27] FOGLIA Similgold LA 50 internal 38		[27] FOGLIA Similsilver LA 51 LA 52 external 40	
--	--	--	--	---	--	--	--

PEREMPORY WITH MARBLE TOP LA 63 - LA 64
INSTALL SIPHON WITH OVERALL LESS THAN CM. 9

CORE

for one or two undertop - overtop washbasin

[137]



MO 2420
L 130/110 P 64 H 83
one big drawer

[236]

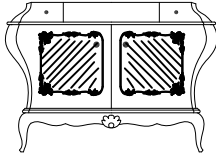

MO 2440
L 132/110 P 60 H 82
**two doors
two drawers**

[275]

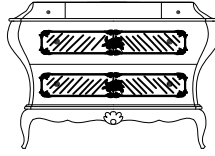

MO 2441
L 132/110 P 60 H 82
**two big drawers
two drawers**

[325]

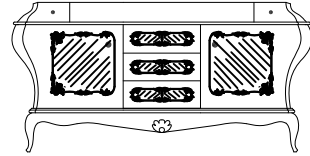

MO 2442
L 176/152 P 60 H 82
**two doors
three drawers**

CRYSTAL TOP

with washbasin **INCREASE +10% WAVE MANUFACTURE** - OPTIONAL linear riser h 4 cm linear meter [10] or shaped riser h 10 cm linear meter [15]

[80]

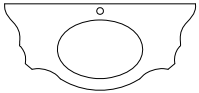

POCRI93
L 133/115 P 66 H 1,5

[76]

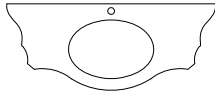

POCRI40
L 123/104 P 59 H 1,5

[92]

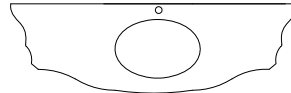

POCRI41
L 166/148 P 59 H 1,5

[123]

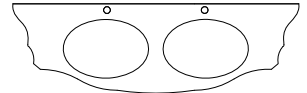

POCRI42
L 166/148 P 59 H 1,5

MARBLE TOP

for one or two undertop - overtop washbasin **INCREASE +25% THICKNESS CM.3**

POMA175 undertop
POMA275 overtop
L 135/115 P 67 H 2

C1	[39]
C2	[48]
C3	[59]
C4	[65]
C5	[73]

POMA194 undertop
POMA294 overtop
L 124/105 P 59 H 2

C1	[36]
C2	[45]
C3	[56]
C4	[61]
C5	[68]

POMA195 for 1 undertop
POMA295 for 1 overtop
POMA196 for 2 undertops
POMA296 for 2 overtops
L 167/149 P 59 H 2

POMA12 for 1 undertop
POMA212 for 1 overtop
POMA63 for 2 undertops
POMA263 for 2 overtops
L 167/149 P 59 H 2

- | | |
|----|--------|
| C1 | [50] |
| C2 | [62] |
| C3 | [76] |
| C4 | [83] |
| C5 | [93] |

MIRRORS

[50]

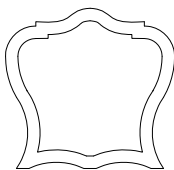

SP 250
L 93/82 H 90

[83]

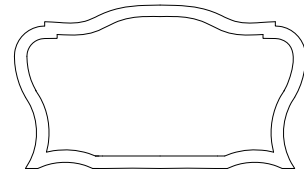

SP 267
L 150/140 H 90

ACCESSORIES

[210]

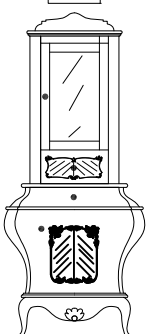

VT 2440 Sx-Dx
L 71/53 P 38 H 180
**two doors
two drawers**

[402]

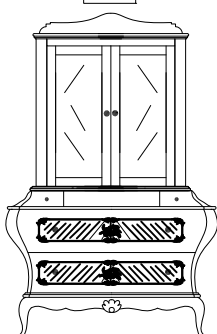

VT 2441
L 132/110 P 38 H 180
**two doors
two drawers
two big drawers**

[277]

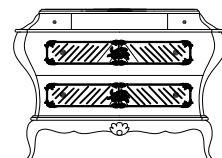

VT 2442
L 132/110 P 38 H 85
**two big drawers
two drawers**

[122]



VT 2443 Sx-Dx
L 71/53 P 38 H 85
**one door
one drawer**

INTERNAL BOTTOM DRAWER - BIG DRAWER AND DOOR 'S COATING
STANDARD LACE AND ECO-LEATHER CORD SAME AS HANDLES **OR/CO/BR**
ON DEMAND CHOOSE COLOR LACE OR ECOLEATHER AND CORD ECOLEATHER **A PRICE LIST**

MAKEUP CORE central

MAKEUP CORE
match it with cores or
makeup core central

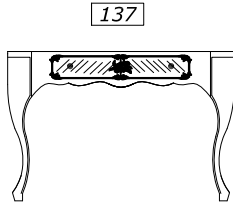

MO 2426
L 130/110 P 64 H 83
one big drawer

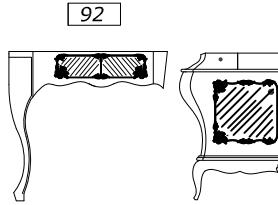

MO 2427 sx
L 85 P 48 H 83
one big drawer

- MO 2420
- MO 2440
- MO 2441
- MO 2442
- MO 2426

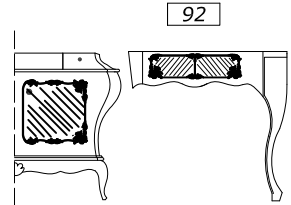

MO 2427 dx
L 85 P 48 H 83
one big drawer

WOOD TOP

CRYSTAL TOP

INCREASE +10% WAVE MANUFACTURE -
 OPTIONAL linear riser h 4 cm linear meter 10 or shaped rider h 10 cm linear meter 15 MAX LENGTH 2,25ml

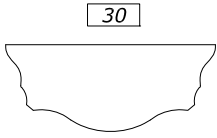

POLEG2312
L 135/115 P 67 H 2

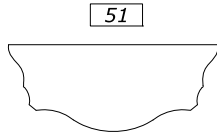

POCRI24
L 133/113 P 66 H 1,5

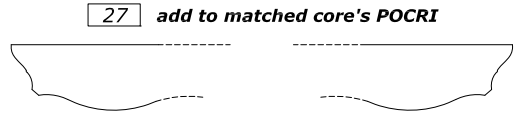

POCRI28 dx/sx
L 86 P 49 H 1,5

27 add to matched core's POCRI

MARBLE TOP

INCREASE +25% THICKNESS CM.3 MAX LENGTH L 2,25 ml

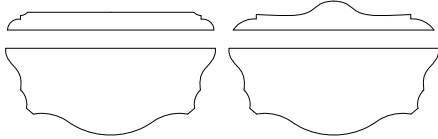

POMA105 L 135/115 P 67 H 2
 POMA106 L 135/115 P 67 H 2

- C1 35
- C2 45
- C3 56
- C4 62
- C5 69

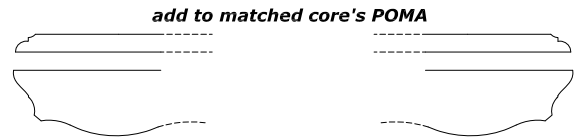

POMA107 dx/sx
L 87 P 51 H 2

add to matched core's POMA

- C1 23
- C2 29
- C3 36
- C4 40
- C5 45

MIRRORS

100

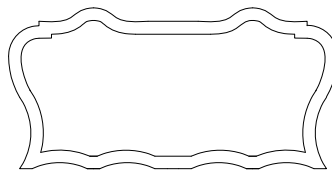

SP 263
L 180/168 H 90

ACCESSORIES

FINISH'S INCREASE

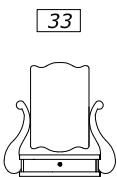

CD 94
L 68 P 20 H 60
PETTINEUSE
one drawer



CD 70
L 43 P 43 H 46
pouf seat
ecoleather smooth



CD 71
L 43 P 43 H 46
pouf seat
ecoleather capitonné

increase for swarovski 6

ROSSO M. - NOCE D. PRICE LIST

Knob Q

IMPORTANT
COMPATIBLE WITH
WASHBASIN OF MAX SIZE
LA 63 - LA 64

INTARSIO FLOREALE ON THE FRONT OF CORES AND CABINETS

UNDERTOP WASHBASIN [8] LA 63 WHITE [13] LA 64 BLACK internal 36,5x51,5 external 41x56		OVERTOP WASHBASIN [27] FOGLIA Similgold LA 50 [27] FOGLIA Similsilver LA 51 LA 52 internal 38 external 40	
PEREMPTORY WITH MARBLE TOP LA 63 - LA 64 INSTALL SIPHON WITH OVERALL LESS THAN CM. 9			

CORE

for one undertop - overtop washbasin

[176]

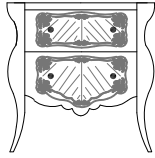

MO 2400
L 90/72 P 58 H 83
two big drawers

[123]

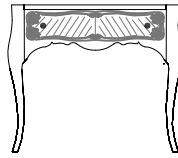

MO 2401
L 115/95 P 58 H 83
one big drawer

[186]

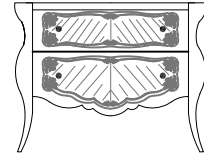

MO 2402
L 115/95 P 58 H 83
two big drawers

CRYSTAL TOP

with washbasin INCREASE +10% WAVE MANUFACTURE - OPTIONAL linear riser h 4 cm linear meter [10] or shaped riser h 10 cm linear meter [15]

[57]

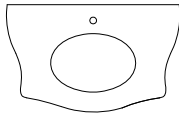

POCRI15
L 89/75 P 58 H 1,5

[74]

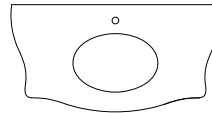

POCRI43
L 113/99 P 58 H 1,5

MARBLE TOP

for one undertop - overtop washbasin INCREASE +25% THICKNESS CM.3

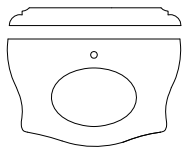

POMA118 undertop
POMA218 overtop
L 91/77 P 59 H 2

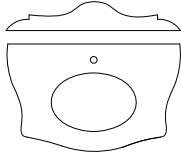

POMA119 undertop
POMA219 overtop
L 91/77 P 59 H 2

- C1 [27]
- C2 [33]
- C3 [41]
- C4 [45]
- C5 [50]

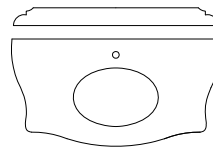

POMA139 undertop
POMA239 overtop
L 116/100 P 59 H 2

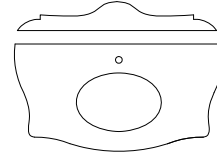

POMA24 undertop
POMA224 overtop
L 116/100 P 59 H 2

- C1 [35]
- C2 [44]
- C3 [53]
- C4 [59]
- C5 [66]

MIRRORS

[46]

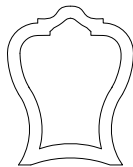

SP 252
L 71/60 H 90

[50]

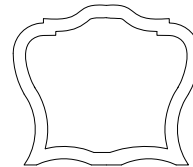

SP 250
L 93/82 H 90

ACCESSORIES

[191]

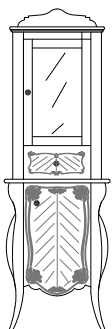

VT 2400 Sx-Dx
L 65/53 P 38 H 180
**two doors
one drawer**

[315]

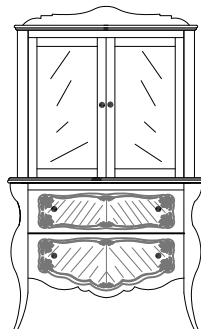

VT 2403
L 106/100 P 41 H 180
**two doors
two big drawers**

[190]

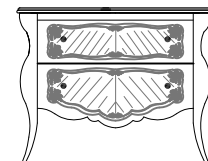

VT 2404
L 106/100 P 41 H 85
two big drawers

[108]

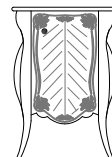

VT 2401 Sx-Dx
L 65/53 P 38 H 85
one door

INTERNAL BOTTOM DRAWER - BIG DRAWER AND DOOR 'S COATING
STANDARD LACE AND ECO-LEATHER CORD SAME AS HANDLES **OR/CO/BR**
ON DEMAND CHOOSE COLOR LACE OR ECOLEATHER AND CORD ECOLEATHER **A PRICE LIST**

LINED WOOD

MAKEUP CORE central

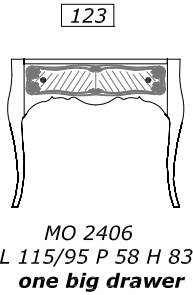

MAKEUP CORE
match it with cores or
makeup core central

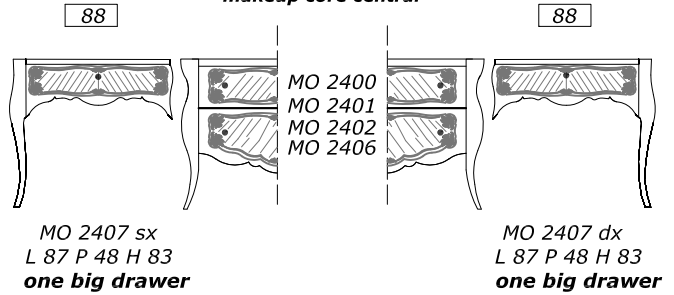

WOOD TOP

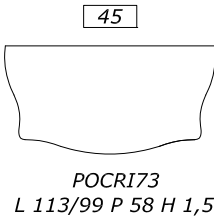
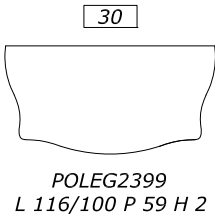

CRYSTAL TOP

INCREASE +10% WAVE MANUFACTURE -
 OPTIONAL linear riser h 4 cm linear meter 10 or shaped rider h 10 cm linear meter 15 MAX LENGTH 2,25ml

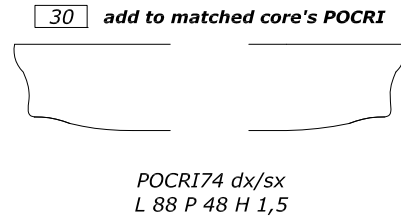

MARBLE TOP

INCREASE +25% THICKNESS CM.3 MAX LENGTH L 2,25 ml

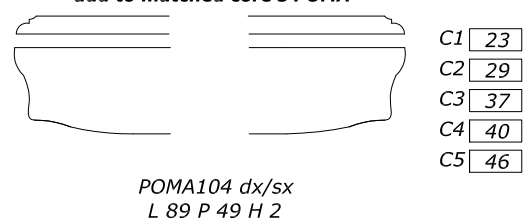
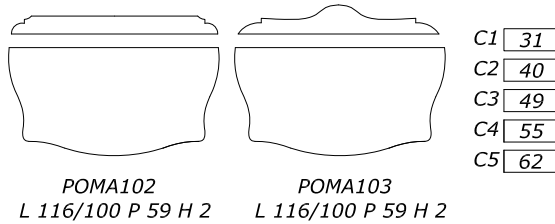

MIRRORS

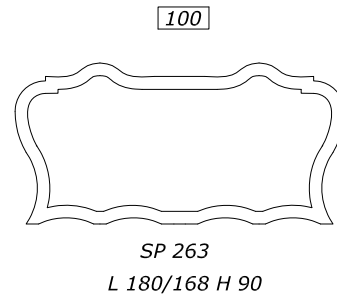
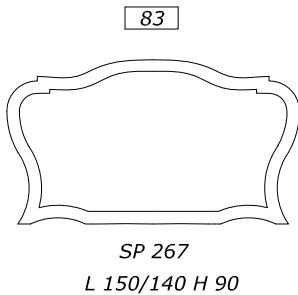

ACCESSORIES

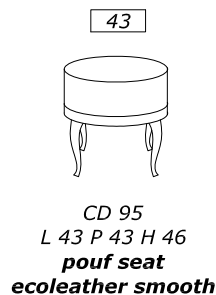
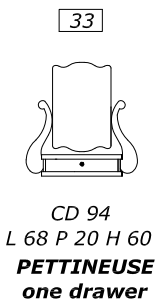

increase for swarovski 6

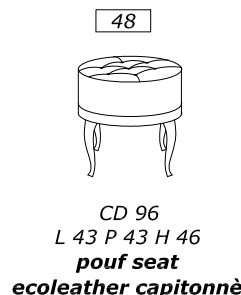

FINISH'S INCREASE

ROSSO M. - NOCE D. PRICE LIST

Knob Q

IMPORTANT
COMPATIBLE WITH
WASHBASIN OF MAX SIZE
LA 63 - LA 64

INTARSIO FLOREALE ON THE FRONT OF CORES AND CABINETS

UNDERTOP WASHBASIN 8 LA 63 WHITE 13 LA 64 BLACK internal 36,5x51,5 external 41x56		OVERTOP WASHBASIN 27 FOGLIA Similgold LA 50 27 FOGLIA Similsilver LA 51 LA 52 internal 38 external 40	
---	--	---	--

PEREMPATORY WITH MARBLE TOP LA 63 - LA 64
INSTALL SIPHON WITH OVERALL LESS THAN CM. 9

CORE

for one or two undertop - overtop washbasin

254

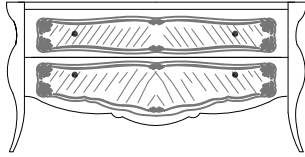

MO 2403
L 173/153 P 58 H 83
two big drawers

311

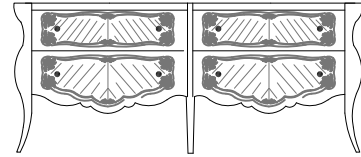

MO 2404
L 203/182 P 58 H 83
four big drawers

CRYSTAL TOP

with washbasin INCREASE +10% WAVE MANUFACTURE - OPTIONAL linear riser h 4 cm linear meter 10 or shaped riser h 10 cm linear meter 15

92

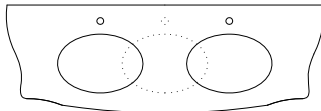

POCRI44 for 1 washbasin
L 172/156 P 58 H 1,5

123

POCRI45 for 2 washbasins
L 172/156 P 58 H 1,5

137

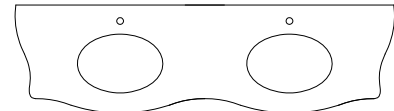

POCRI46
L 200/185 P 58 H 1,5

MARBLE TOP

for one or two undertop - overtop washbasin INCREASE +25% THICKNESS CM.3

POMA116 one undertop
POMA216 one overtop
L 173/157 P 59 H 2

POMA115 two undertops
POMA215 two overtops

- C1 51
- C2 63
- C3 79
- C4 86
- C5 97

POMA04 one undertop
POMA204 one overtop
L 173/157 P 59 H 2

POMA02 two undertops
POMA202 two overtops

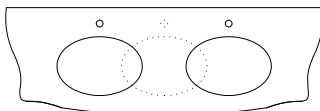

POMA117 undertop
POMA217 overtop
L 202/186 P 59 H 2

- C1 62
- C2 76
- C3 94
- C4 103
- C5 115

POMA43 undertop
POMA243 overtop
L 202/186 P 59 H 2

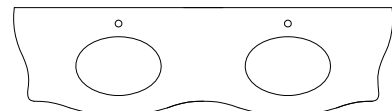

MIRRORS

83

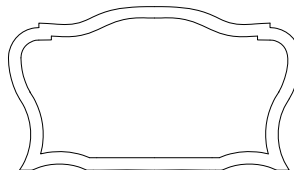

SP 267
L 150/140 H 90

ACCESSORIES

191

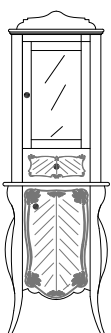

VT 2400 Sx-Dx
L 65/53 P 38 H 180
two doors
one drawer

315

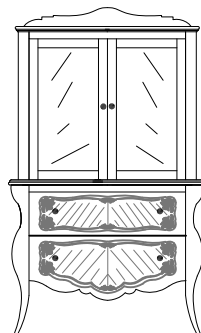

VT 2403
L 106/100 P 41 H 180
two doors
two big drawers

190

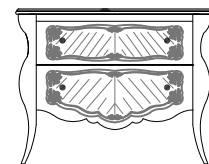

VT 2404
L 106/100 P 41 H 85
two big drawers

108



VT 2401 Sx-Dx
L 65/53 P 38 H 85
one door

INTERNAL BOTTOM DRAWER - BIG DRAWER AND DOOR 'S COATING
STANDARD LACE AND ECO-LEATHER CORD SAME AS HANDLES **OR/CO/BR**
ON DEMAND CHOOSE COLOR LACE OR ECOLEATHER AND CORD ECOLEATHER **A PRICE LIST**

MAKEUP CORE central

MAKEUP CORE
match it with cores or
makeup core central

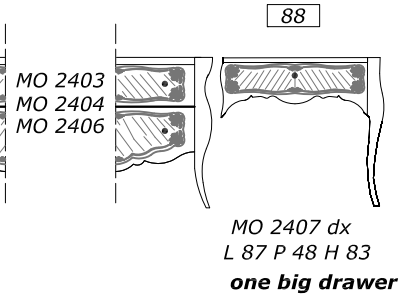
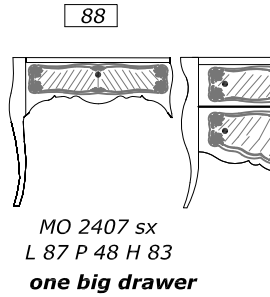
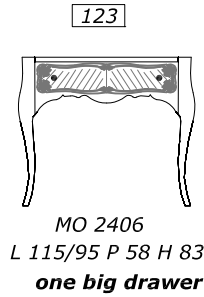

WOOD TOP

CRYSTAL TOP

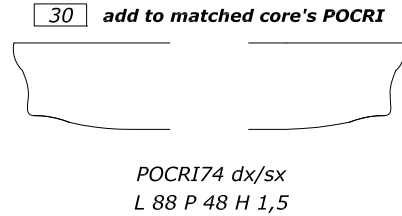
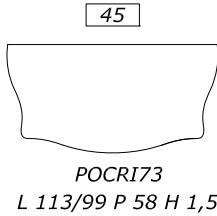
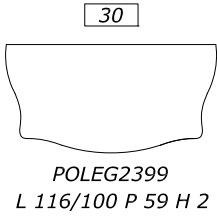

MARBLE TOP

INCREASE +25% THICKNESS CM.3 MAX LENGTH L 2,25 ml

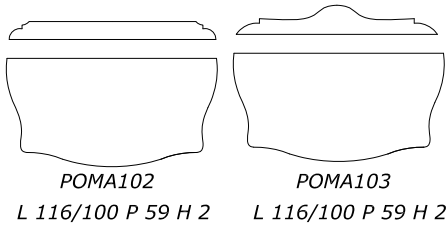

- C1 31
- C2 40
- C3 49
- C4 55
- C5 62

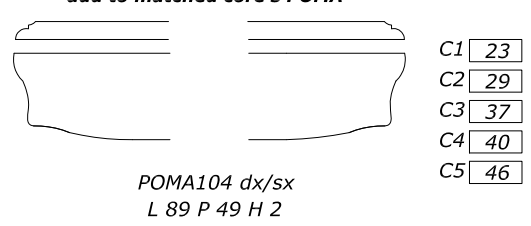

- C1 23
- C2 29
- C3 37
- C4 40
- C5 46

MIRRORS

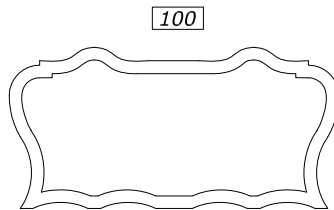

SP 263
L 180/168 H 90

ACCESSORIES

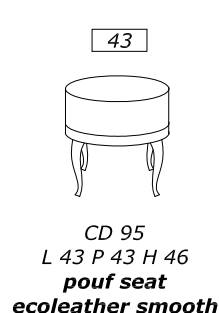
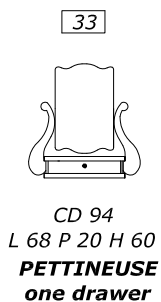

increase for swarovski 6

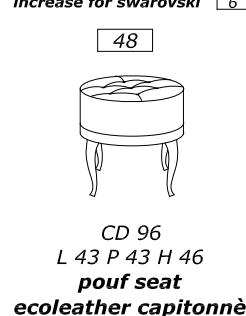

FINISH'S INCREASE

ROSSO M. - NOCE D. PRICE LIST

Knob Q

IMPORTANT
COMPATIBLE WITH
WASHBASIN OF MAX SIZE
LA 63 - LA 64 - LA 03

INTARSIO FLOREALE ON THE FRONT OF CORES AND CABINETS

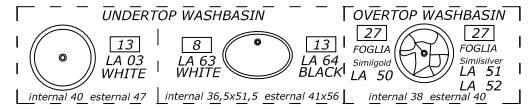

PEREMPORY WITH MARBLE TOP LA 63 - LA 64
INSTALL SIPHON WITH OVERALL LESS THAN CM. 9

CORE

for one or two undertop - overtop washbasin

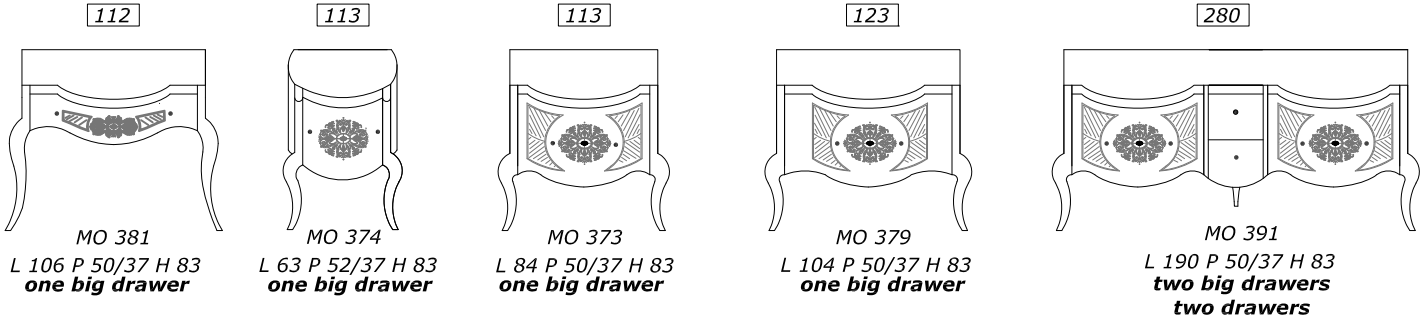

CERAMIC TOP

except of CORE MO 381

CRYSTAL TOP

with washbasin **INCREASE +10% WAVE MANUFACTURE -**
OPTIONAL linear riser h 4 cm linear meter **10** or shaped riser h 10 cm linear meter **15**

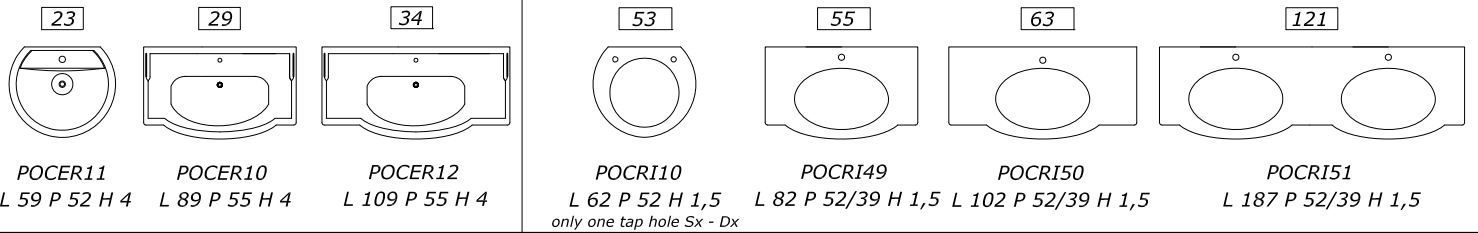

MARBLE TOP

for one or two undertop - overtop washbasin **INCREASE +25% THICKNESS CM.3**

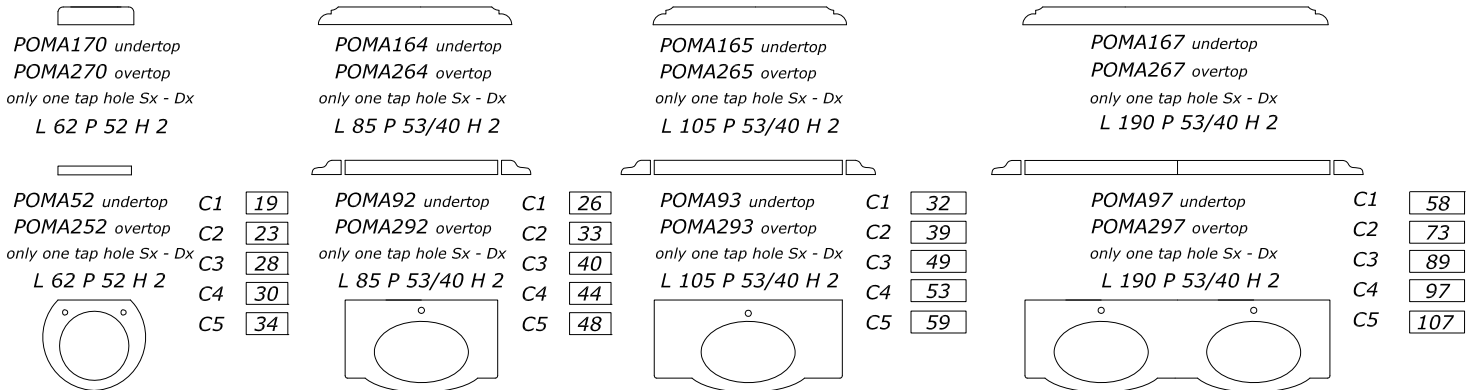

MIRRORS

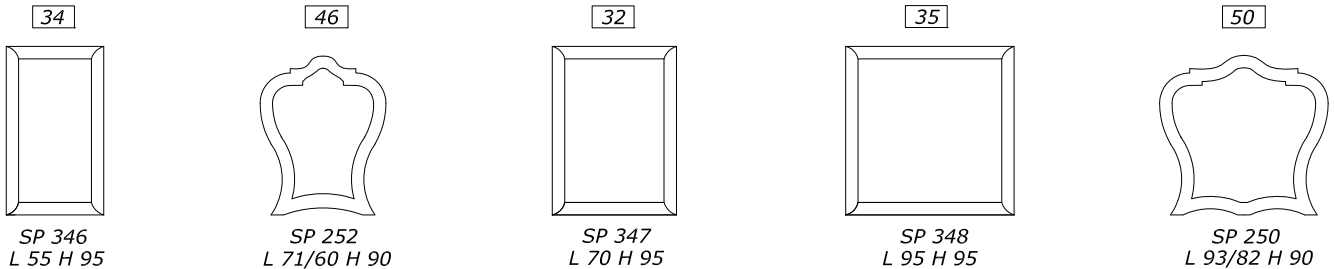

ACCESSORIES

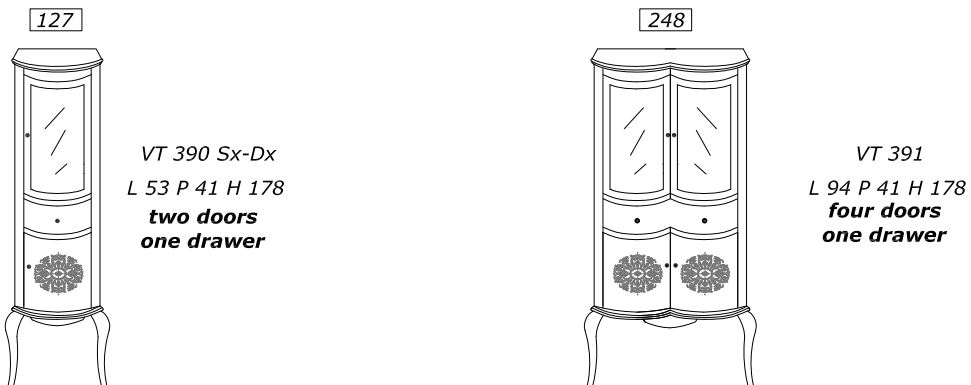

INTERNAL BOTTOM DRAWER - BIG DRAWER AND DOOR 'S COATING
STANDARD LACE AND ECO-LEATHER CORD SAME AS HANDLES **OR/CO/BR**
ON DEMAND CHOOSE COLOR LACE OR ECOLEATHER AND CORD ECOLEATHER **A PRICE LIST**

MAKEUP CORE central

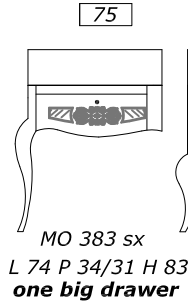
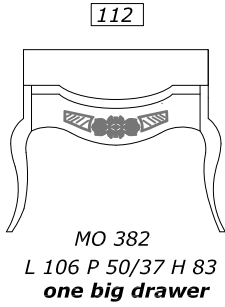

MAKEUP CORE
match it with cores or
makeup core central

- MO 381
- MO 374
- MO 373
- MO 379
- MO 391
- MO 382

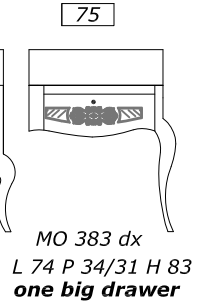

WOOD TOP

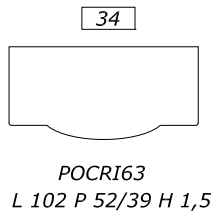
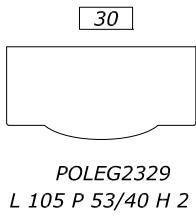

CRYSTAL TOP

INCREASE +10% WAVE MANUFACTURE -
OPTIONAL linear riser h 4 cm linear meter 10 or shaped rider h 10 cm linear meter 15 MAX LENGTH 2,25ml

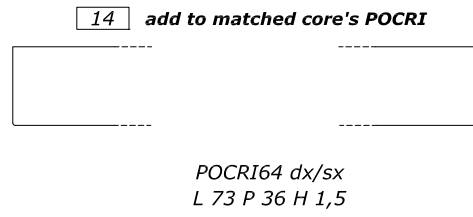

MARBLE TOP

INCREASE +25% THICKNESS CM.3 MAX LENGTH L 2,25 ml

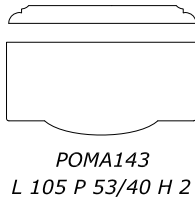

- C1 28
- C2 35
- C3 45
- C4 49
- C5 55

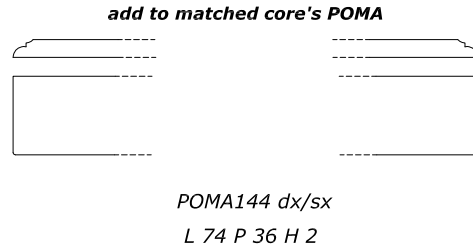

- C1 19
- C2 24
- C3 31
- C4 34
- C5 38

MIRRORS

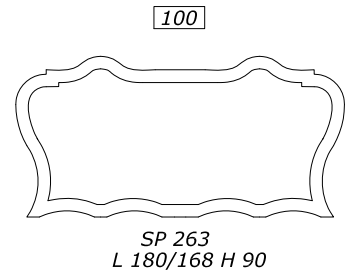
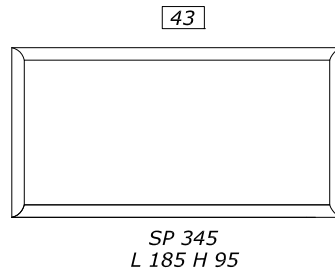
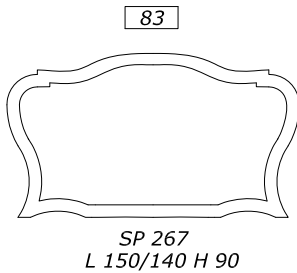
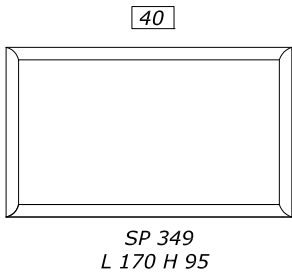

ACCESSORIES

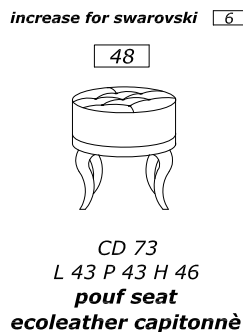
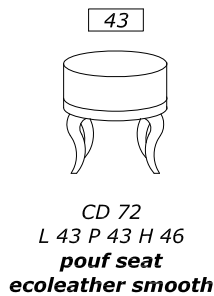
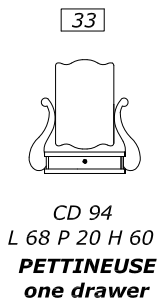

FINISH'S INCREASE

ROSSO M. - NOCE D. PRICE LIST

Knob Q

IMPORTANT
COMPATIBLE WITH
WASHBASIN OF MAX SIZE
LA 63 - LA 64

INTARSIO FLOREALE ON THE FRONT OF CORES AND CABINETS

UNDERTOP WASHBASIN [8] LA 63 WHITE internal 36,5x51,5		OVERTOP WASHBASIN [13] LA 64 BLACK internal 41x56		[27] FOGLIA Similgold LA 50 internal 38		[27] FOGLIA Similsilver LA 51 LA 52 external 40	
--	--	--	--	---	--	--	--

PEREMPATORY WITH MARBLE TOP LA 63 - LA 64
INSTALL SIPHON WITH OVERALL LESS THAN CM. 9

CORE

for one or two undertop - overtop washbasin

[112]

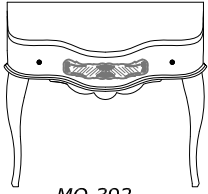

MO 392
L 106 P 58/41 H 82
one big drawer

[143]

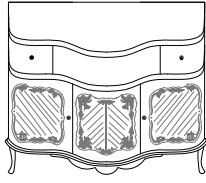

MO 346
L 106 P 58/41 H 82
**three doors
two drawers**

[162]

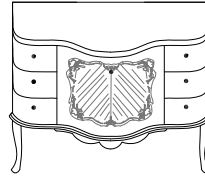

MO 347
L 106 P 58/41 H 82
**one big drawer
six drawers**

[144]

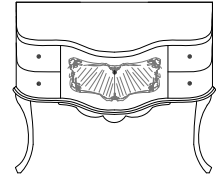

MO 359
L 106 P 58/41 H 82
**one big drawer
four drawers**

[300]

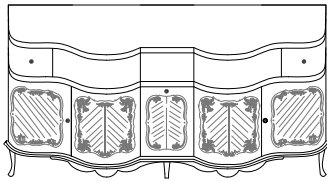

MO 349
L 174 P 58/41 H 82
**four doors
one basket
two drawers**

[300]

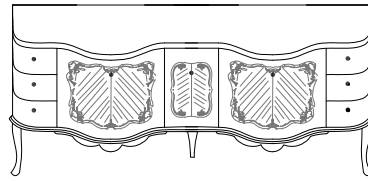

MO 350
L 189 P 58/41 H 82
**two big drawers
one basket
six drawers**

CERAMIC TOP

except of CORE MO 392

[54]

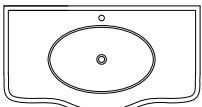

POCER59
L 110 P 61 H 4

[71]

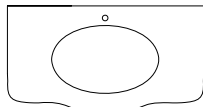

POCRI60
L 105 P 59/42 H 1,5

[123]

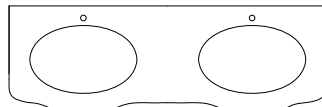

POCRI61
L 173 P 59/42 H 1,5

[129]

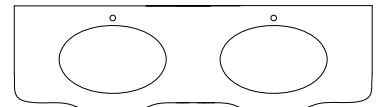

POCRI62
L 189 P 59/41 H 1,5

CRYSTAL TOP

with washbasin INCREASE +10% WAVE MANUFACTURE -
OPTIONAL linear riser h 4 cm linear meter [10] or shaped riser h 10 cm linear meter [15]

MARBLE TOP

for one or two undertop - overtop washbasin INCREASE +25% THICKNESS CM.3

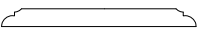

POMA109 undertop
POMA209 overtop
L 107 P 60/43 H 2

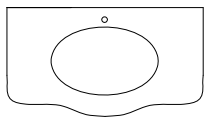

C1 [33]
C2 [41]
C3 [51]
C4 [56]
C5 [62]

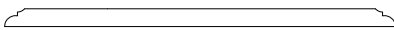

POMA100 undertop
POMA200 overtop
L 175 P 60/43 H 2

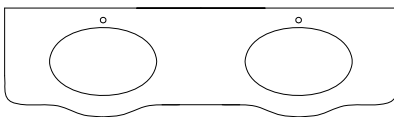

C1 [54]
C2 [67]
C3 [82]
C4 [89]
C5 [100]

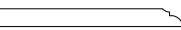

POMA101 undertop
POMA201 overtop
L 192 P 60/43 H 2

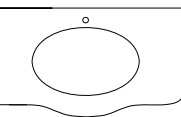

C1 [58]
C2 [72]
C3 [88]
C4 [96]
C5 [108]

MIRRORS

[35]

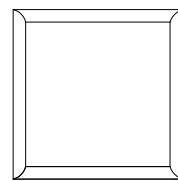

SP 348
L 95 H 95

[50]

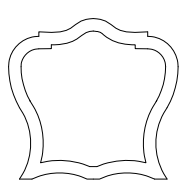

SP 250
L 93/82 H 90

ACCESSORIES

[127]

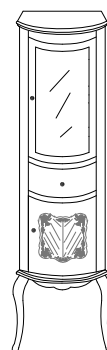

VT 350 Sx-Dx
L 53 P 41 H 178
**two doors
one drawer**

INTERNAL BOTTOM DRAWER - BIG DRAWER AND DOOR 'S COATING
STANDARD LACE AND ECO-LEATHER CORD SAME AS HANDLES **OR/CO/BR**
ON DEMAND CHOOSE COLOR LACE OR ECOLEATHER AND CORD ECOLEATHER **A PRICE LIST**

LINDEN WOOD

MAKEUP CORE central

MAKEUP CORE

match it with cores or makeup core central

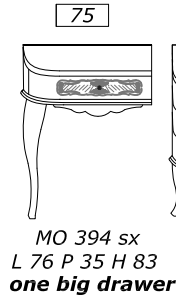

- MO 392
- MO 346
- MO 347
- MO 359
- MO 349
- MO 350
- MO 393

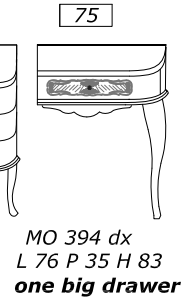

WOOD TOP

CRYSTAL TOP

INCREASE +10% WAVE MANUFACTURE -
OPTIONAL linear riser h 4 cm linear meter 10 or shaped rider h 10 cm linear meter 15 **MAX LENGTH 2,25ml**

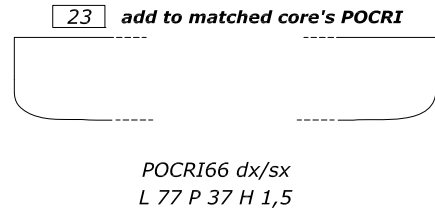
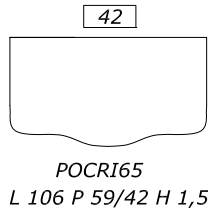
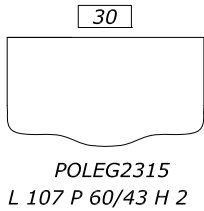

MARBLE TOP

INCREASE +25% THICKNESS CM.3 MAX LENGTH L 2,25 ml

add to matched core's POMA

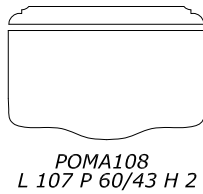

- C1 29
- C2 37
- C3 47
- C4 52
- C5 58

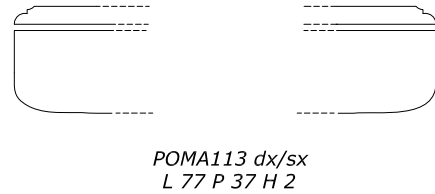

- C1 20
- C2 25
- C3 32
- C4 35
- C5 40

MIRRORS

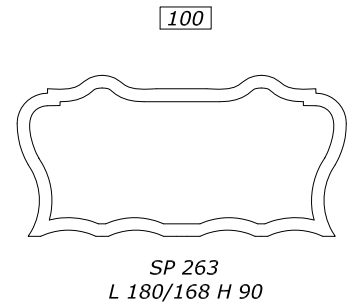
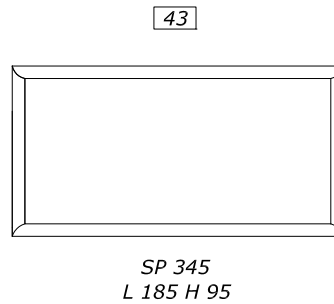
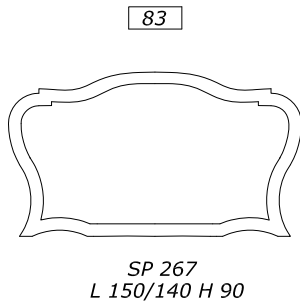
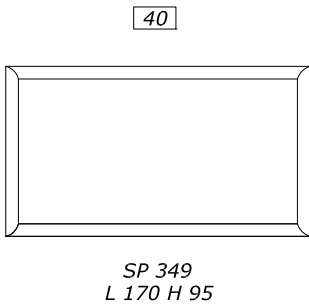

ACCESSORIES

FINISH'S INCREASE

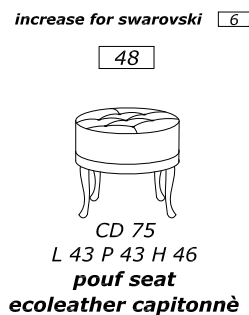
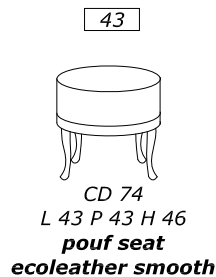
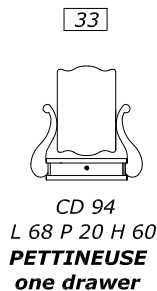
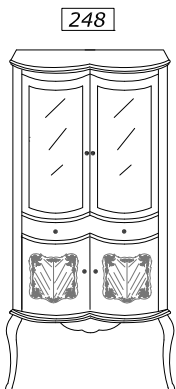

ROSSO M. - NOCE D. PRICE LIST

KNOBS & HANDLES



TRASPARENTE STONE

RUBINO STONE

TOPAZIO STONE

NERA STONE

A100 EOR

A110 EOR

A120 EOR

A130 EOR

A101 ECO

7

A111 ECO

7

A121 ECO

7

A131 ECO

7

A102 EBR

A112 EBR

A122 EBR

A132 EBR

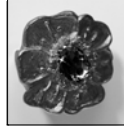
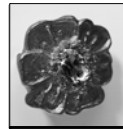
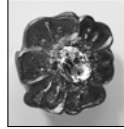
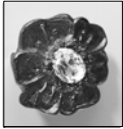

TRASPARENTE STONE

RUBINO STONE

TOPAZIO STONE

NERA STONE

A103 EOR

A113 EOR

A123 EOR

A133 EOR

A104 ECO

4

A114 ECO

4

A124 ECO

4

A134 ECO

4

A105 EBR

A115 EBR

A125 EBR

A135 EBR



TRASPARENTE STONE

RUBINO STONE

TOPAZIO STONE

NERA STONE

A106 EOR

A116 EOR

A126 EOR

A136 EOR

A107 ECO

3

A117 ECO

3

A127 ECO

3

A137 ECO

3

A108 EBR

A118 EBR

A128 EBR

A138 EBR

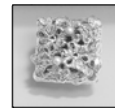

A25 EOR

7

A20 EOR

4

A15 EOR

3

A26 ECO

A21 ECO

A16 ECO

A27 EBR

A22 EBR

A17 EBR

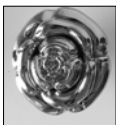

BIG ROSA

MEDIUM ROSA

SMALL ROSA

A140 BOR

2

A143 BOR

2

A146 BOR

1

A141 BCO

A144 BCO

A147 BCO

A142 BBR

A145 BBR

A148 BBR

APPLIQUES & LAMPS

CAPITONNE' ECOLEATHER BUTTON 18 COLORS - FAN-HAT WHITE BLACK or PERGAMENA

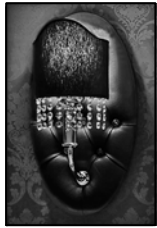

	LUXURY			ELEGANCE		
	AC 2670	AC 2671	AC 2672	AC 2520	AC 2521	AC 2522
	OCTAGONAL TUBE	SPIRE TUBE	RUOND TUBE	OCTAGONAL TUBE	SPIRE TUBE	RUOND TUBE
CO	32	30	30	30	27	27
OR	34	32	32	32	29	29
BR	34	32	32	32	29	29

L 25 P 18 H 50

INCREASE BOTTONI SWAROVSKY 3

CAPITONNE' ECOLEATHER BUTTON 18 COLORS - LUXURY CEILING LAMP



	AC 2680	AC 2681	AC 2687
	OCTAGONAL TUBE	SPIRE TUBE	RUOND TUBE
	CO	170	168
OR	175	173	173
BR	175	173	173

L 65 P 45 H 75

INCREASE SWAROVSKY BUTTON 18

CAPITONNE' ECOLEATHER BUTTON 18 COLORS - LUXURY CEILING LAMP



	AC 2685	AC 2686	AC 2687
	OCTAGONAL TUBE	SPIRE TUBE	RUOND TUBE
	CO	200	198
OR	208	206	206
BR	208	206	206

L 100 P 50 H 75

INCREASE SWAROVSKY BUTTON 25

HAND MADE MIRROR VENICE ART

BLOWN GLASS VENICE ART



L 32 H 40 P 15 1 LUCE

AC 775 20



Ø 46 H 28 3 LUCI

AC 776 65



Ø 62 H 40 5 LUCI

AC 778 95



L 22 H 23 P 24 1 LUCE
FINISHES CO - OR

AC 770 28

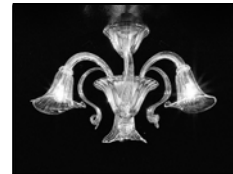

Ø 74 H 36 3 LUCI
FINISHES CO - OR

AC 771 40



Ø 81 H 36 5 LUCI
FINISHES CO - OR

AC 772 100

TABLE LAMP FOGLIA AE - OR



AC 768
Ø 40 H 65
1 LUCE
30

CORE FINISH

FOOR
FOAE



HAT FINISH

WHITE
BLACK
PERGAMENA



STANDARD FEATURES OF FURNITURE – CONSOLE - WINDOW – MIRROR FINISHES

THE MAIN COMPONENT OF OUR FURNITURE, WINDOWS, MIRRORS AND FRAMES IS **"WOOD"**. SOLID WOOD IS USED FOR THE BEARING STRUCTURES WHILE PLYWOOD AND PRESSED WOOD ARE USED FOR DOORS, SIDES AND CARVINGS. THE DIFFERENT CHARACTERISTICS OF WOOD SUCH AS GRAIN, SURFACE ABSORPTION, TOGETHER WITH THE MANUAL PROCESSING AND FINISHES APPLIED TO ASSEMBLED FURNITURE MAY LEAD TO SLIGHT IMPERFECTIONS WHICH HOWEVER MUST NOT BE CONSIDERED AS DEFECTS BUT AS A SIGN OF QUALITY. THESE FEATURES CONFIRM THAT OUR PRODUCTS ARE MADE USING UNIQUE AND ARTISANAL PROCESSES.

FRONT AND SIDE EXTERNAL FINISH - IT MUST COMPLY WITH THE CHARACTERISTICS OF EACH FINISH.
"VISIBLE" INTERNAL FINISH - SUCH AS DRAWERS, LARGE DRAWERS AND DOORS; THE FINISHING PROCESS IS RATHER COMPLEX AS THE FURNITURE IS PAINTED ONCE IT HAS BEEN COMPLETELY ASSEMBLED, FOR THIS REASON THERE MAY BE SOME IMPERFECTIONS WHICH ARE MORE SIGNIFICANT THAN THOSE TYPICAL OF THE EXTERNAL FINISH.
FINISH UNDER AND BEHIND THE PRODUCT AND "INVISIBLE" INTERNAL FINISH – PAINTING OF THESE PARTS IS AN EXTREMELY DIFFICULT PROCEDURE THEREFORE THE FINISH MAY NOT BE ACCURATE OR UNIFORM; CLAIMS FOR THESE IMPERFECTIONS SHALL NOT BE ACCEPTED.

LACCATO FINISH

SMALL SPOTS AND CRATERS OF A MAXIMUM OF ABOUT 2MM ARE ALLOWED DUE TO THE DIFFICULT MANUAL APPLICATION PROCEDURE AND TO THE DIFFERENT COATS OF PAINT APPLIED TO THE PRODUCTS.

BRILLANTE AND MADREPERLA FINISHES

SMALL SPOTS AND CRATERS OF A MAXIMUM OF ABOUT 2MM ARE ALLOWED DUE TO THE DIFFICULT MANUAL APPLICATION PROCEDURE AND TO THE DIFFERENT COATS OF PAINT APPLIED TO THE PRODUCTS. THESE IMPERFECTIONS MAY BE MORE EVIDENT THAN WITH THE LACCATO FINISH AS THE SURFACES ARE GLOSSY.

ANTICATO AND PATINATO FINISHES

SMALL SPOTS AND CRATERS OF A MAXIMUM OF ABOUT 2MM ARE ALLOWED DUE TO THE DIFFICULT MANUAL APPLICATION PROCEDURE AND TO THE DIFFERENT COATS OF PAINT APPLIED TO THE PRODUCTS. THESE FINISHES ARE APPLIED BY HAND THEREFORE EACH PRODUCT WILL BE SLIGHTLY DIFFERENT AS REGARDS THE INTENSITY OF THE PATINAS WHICH SLIGHTLY CHANGE THE SHADE OF THE PRODUCT COLOUR; IN THE CASE OF THE ANTICATO FINISH, THE SCRATCHES ARE PERFORMED RANDOMLY HORIZONTALLY AND VERTICALLY.

FOGLIA FINISH

THIS FINISH IS PERFORMED COMPLETELY BY HAND. THE LEAF, WHICH MEASURES 13X13 CM, IS GLUED ONTO EACH ITEM OF FURNITURE WITH A VERY SPECIAL PROCEDURE TO GUARANTEE ITS DURATION IN TIME. THIS SPECIAL PROCEDURE GENERATES A REACTION OF THE LEAF WHICH MAY "CURL UP"; THE SIZE OF THE "CURL" DEPENDS ON APPLICATION TIME AND TEMPERATURE. FOR THIS REASON, THE OVERLAYING OF ONE LEAF ON TOP OF ANOTHER MAY NOT BE PERFECT, REVEALING SMALL FISSURES OF A MAXIMUM LENGTH OF 3-4 MM THAT EXPOSE THE BASE; ON VERY SMALL AREAS OF A MAXIMUM OF ABOUT 3 MM THE LEAF MAY BE MISSING; LARGE FISSURES OF A MAXIMUM OF 10 – 15 MM MAY ALSO APPEAR, WHICH ARE COVERED WITH THE LEAF BEFORE APPLYING THE SEMI-GLOSSY PROTECTIVE FINISHING VARNISH; SMALL SPOTS AND CRATERS OF A MAXIMUM OF ABOUT 2MM ARE ALLOWED ALSO FOR THIS FINISH.

SPAZZOLATO – VELATO - DECAPE' FINISHES

THIS FINISH IS PERFORMED COMPLETELY BY HAND; THE BRUSHING OF THE GRAIN ON THE SURFACE OF ASH WOOD CAN CREATE SMALL CHIPS ON THE EDGES AND CORNERS; SMALL SPOTS AND CRATERS OF A MAXIMUM OF ABOUT 2 MM ARE ALLOWED.

NERO FUMO – ROSSO MODENA – NOCE DORATO – CILIEGIO – MIELE FINISHES

THESE ARE TRANSPARENT FINISHING VARNISHES THAT SHOW THE STRUCTURE AND GRAIN OF THE WOOD; THE COLOUR SHADE MAY VARY DUE TO THE ACTUAL WOOD OR TO CARVINGS; SMALL SPOTS AND CRATERS OF A MAXIMUM OF ABOUT 2MM ARE ALSO ALLOWED.

DECORATI FINISH

ONCE THE PIECE OF FURNITURE HAS BEEN PAINTED OF THE REQUIRED COLOUR, THE TEMPLATE OF THE DRAWING IS APPLIED ON THE BASE; THE COLOUR OF THE DECORATION IS APPLIED SEVERAL TIMES OVER THE TEMPLATE TO CREATE A RELIEF PATTERN; THE TEMPLATE IS THEN REMOVED, THE PRODUCT IS SANDED AND THE PATINA IS APPLIED.

SMALL SPOTS AND CRATERS OF A MAXIMUM OF ABOUT 2MM ARE ALLOWED FOR ALL THESE MANUAL FINISHES. THE TEMPLATE IS REMOVED BY HAND AND THIS COULD RESULT IN AN IRREGULAR CONTOUR IN CERTAIN PARTS OF THE DECORATION; THE IMPERFECTIONS ARE OF A MAXIMUM OF 3-4 MM AND ARE TOUCHED UP WITH THE APPROPRIATE COLOUR.

PASTELLI FINISH

THE FINISH IS APPLIED COMPLETELY BY HAND; THE COLOURS OF THE BASE AND DECORATION ARE APPLIED WITH A PAINTBRUSH.

SMALL SPOTS AND CRATERS OF A MAXIMUM OF ABOUT 2MM ARE ALLOWED.

PATINATO / LACCATO FINISHES SFUMATO ORO – ARGENTO – BRONZO NERO FUMO / ROSSO MODENA / NOCE DORATO FINISHES SFUMATO ORO – ARGENTO – BRONZO

SMALL SPOTS AND CRATERS OF A MAXIMUM OF ABOUT 2MM ARE ALLOWED. THESE ARE DUE TO THE DIFFICULT MANUAL APPLICATION PROCEDURE AND TO THE DIFFERENT COATS OF PAINT APPLIED TO THE PRODUCTS. THESE PROCESSES ARE CARRIED OUT COMPLETELY BY HAND THEREFORE EACH PIECE OF FURNITURE IS DIFFERENT. THE CONTOURS OF THE PART SFUMATA ORO ARGENTO AND BRONZO MAY BE SLIGHTLY SMUDGED IN CERTAIN PARTS.

IN CERTAIN POINTS, THE SFUMATE ORO ARGENTO AND BRONZO PARTS, ARE LIGHTLY SANDED TO REVEAL THE BASE COLOUR.

OTTONE ORO - BRONZO - CROMO FINISHES

SMALL SPOTS AND CRATERS OF A MAXIMUM OF ABOUT 2MM ARE ALLOWED. DIFFERENCES IN THE SHADE AND BRILLIANCE OF EACH PRODUCT ARE ALSO ALLOWED; THEY ARE MORE ACCENTUATED IN THE BRONZE FINISH AS THE PRODUCTS ARE BRUSHED BY HAND.

ORNAMENT FINISH

SLIGHT DETACHMENTS OF UP TO A MAXIMUM OF 2 MM FROM THE SURFACE OF FURNITURE, WINDOWS AND MIRRORS ARE ALLOWED AS THE ORNAMENTS ARE PROCESSED SEPARATELY AND APPLIED TO THE PAINTED FURNITURE WITH PINS INSTEAD OF GLUE.

COLOURS – METALS

SMALL DIFFERENCES IN SHADE AND BRILLIANCE COMPARED TO THE STANDARD SAMPLES ARE ALLOWED; THE SAMPLES ARE MERELY INDICATIVE AND NOT BINDING.

DIMENSIONS

SMALL DIFFERENCES IN THE DIMENSIONS, MAXIMUM 2%, COMPARED TO THOSE SHOWN IN THE PRICE LIST ARE ALLOWED.

IF THE FURNITURE IS TO BE POSITIONED IN A NICHE THIS MUST BE COMMUNICATED TOGETHER WITH THE DIMENSIONS OF THE NICHE.

STANDARD FEATURES OF THE ARREDO COLLECTION PRODUCTS

FRAMES

GREATER IMPERFECTIONS ARE ALLOWED FOR THE AT-PT-LC-BL-MP-FOOR-FOAE FINISHES COMPARED TO THOSE DESCRIBED IN THE STANDARD FEATURES OF THE FINISHES, UP TO A MAXIMUM OF DOUBLE THE SIZE, DUE TO THE COMPLEX APPLICATION PROCEDURE OF THE FINISHES ON CARVED SURFACES.

WALL LIGHTS – ACCESSORIES – KNOBS – BRASS HANDLES

SMALL SPOTS AND CRATERS OF A MAXIMUM OF ABOUT 2MM ARE ALLOWED. DIFFERENCES IN THE SHADE AND BRILLIANCE OF EACH PRODUCT ARE ALSO ALLOWED; THEY ARE MORE ACCENTUATED IN THE BRONZE FINISH AS THE PRODUCTS ARE BRUSHED BY HAND.

BRASS DECORATIVE HEATED TOWEL RAILS

SMALL SPOTS AND CRATERS OF A MAXIMUM OF ABOUT 2MM ARE ALLOWED. DIFFERENCES IN THE SHADE AND BRILLIANCE OF EACH PRODUCT ARE ALSO ALLOWED; THEY ARE MORE ACCENTUATED IN THE BRONZE FINISH AS THE PRODUCTS ARE BRUSHED BY HAND.

THE DECORATIVE WATER HEATED TOWEL RAILS ARE TESTED AND GUARANTEED FOR A MAXIMUM WORKING PRESSURE OF 6 BAR WITH SHORT INCREASES NOT OVER 8 - 9 BAR.

THE DECORATIVE ELECTRIC HEATED TOWEL RAILS ARE FITTED WITH A 220 VOLT ELECTRIC RESISTANCE POSITIONED INTERNALLY AND IMMERSSED IN AN ANTIFREEZE AND THERMAL FLUID.

CRYSTAL WASH BASINS AND TOPS

THEY ARE MADE OF EXTRA LIGHT CRYSTALS AND LIGHT COLOURS MAY HAVE A SLIGHT AQUAMARINE REFLECTION GIVEN BY THE THICKNESS OF THE CRYSTAL.

SMALL SPOTS AND MISSING PAINT MEASURING A MAXIMUM OF 2MM ARE ALLOWED.

THE TOPS AND WASH BASINS MUST BE FASTENED TO THE FURNITURE AND TO THE WALL **ONLY WITH NEUTRAL SILICONE.**

CERAMIC WASH BASINS AND TOPS

SMALL CRACKS ARE ALLOWED UNDER THE CERAMIC TOP, STUCCOED OR NOT, BECAUSE THEY DO NOT DETRACT FROM THE APPEARANCE OF THE PRODUCT AND DO NOT COMPROMISE ITS GUARANTEE.

SMALL CHIPS MEASURING MAXIMUM 3 TO 5 MM ARE ALLOWED ON THE THREE HOLES OF THE TAPS AND FITTINGS.

SMALL SPOTS AND CRATERS OF A MAXIMUM OF ABOUT 2MM ARE ALLOWED. THESE ARE CAUSED BY THE FIRING TEMPERATURE OF OVER 1200° WHICH GUARANTEES A GREATER PRODUCT RESISTANCE AND BRILLIANCE.

SMALL DIFFERENCES IN SHADE AND BRILLIANCE ARE ALLOWED BETWEEN EACH PRODUCT.

MARBLE TOPS

STUCCOING OF ANY SIZE IS ALLOWED UNDER THE TOP IN ORDER TO MAKE IT MORE UNIFORM AND RESISTANT; THE ADDITION OF PLASTIC MESH IS ALLOWED WHEN NECESSARY.

STUCCOING CARRIED OUT IN A SUITABLE MANNER AND MEASURING A MAXIMUM OF 10 MM IS ALLOWED ON THE UPPER GLOSSY OR ANTIQUE EFFECT SURFACE.

COLOURS – METALS

SMALL DIFFERENCES IN SHADE AND BRILLIANCE COMPARED TO THE STANDARD SAMPLES ARE ALLOWED; THE SAMPLES ARE MERELY INDICATIVE AND NOT BINDING.

DIMENSIONS

SMALL DIFFERENCES IN THE DIMENSIONS, OF A MAXIMUM OF 2%, COMPARED TO THOSE SHOWN IN THE PRICE LIST ARE ALLOWED.

IF THE FURNITURE IS TO BE POSITIONED IN A NICHE THIS MUST BE COMMUNICATED TOGETHER WITH THE DIMENSIONS OF THE NICHE.

FITTING AND FASTENING

FURNITURE, WINDOWS, MIRRORS, FRAMES, WALL LAMPS, LAMPS DECORATIVE HEATED TOWEL RAILS, ACCESSORIES

MOST OF THE WINDOWS AND FURNITURE ARE FITTED, WHERE NECESSARY, WITH SCREW ADJUSTMENT DEVICES UNDER THE FEET OR LEGS TO CORRECTLY POSITION THE PRODUCT ON THE FLOOR AND AGAINST THE WALL. ADJUSTMENTS MUST BE MADE BEFORE THE FURNITURE OR WINDOW IS FASTENED TO THE WALL.

CLAIMS SHALL NOT BE ACCEPTED IF ITEMS OF FURNITURE OR WINDOWS ARE NOT FASTENED TO THE WALL.

FURNITURE, WINDOWS, MIRRORS, FRAMES, WALL LAMPS, LAMPS, DECORATIVE RADIATORS AND ACCESSORIES MUST ALL BE FASTENED IN A STABLE WAY WITH SCREW ANCHORS SUITABLE FOR THE DIFFERENT TYPES OF WALL: HOLLOW BRICK, STONE, CEMENT, PLASTERBOARD, ETC., INTO WHICH THEY ARE TO BE FITTED.

"IL TEMPO DEL ..." IS NOT OBLIGED TO SUPPLY SCREW ANCHORS WITH THE PRODUCT, BUT IF STANDARD SCREW ANCHORS ARE SUPPLIED, YOU MUST CHECK THAT THEY ARE SUITABLE FOR THE WALL IN WHICH THEY ARE TO BE FITTED.

FITTING AND FASTENING

BOISERIE

THE BOISERIE IS MADE UP OF THE FOLLOWING PRODUCTS: PANEL, COLUMN, HANDRAIL, COLUMN TOP, "U" SHAPED METAL GUIDE SUPPLIED IN SECTIONS AND SCREW ANCHORS MM 80 Ø 10 ONLY FOR THE COLUMNS; THESE SCREW ANCHORS ARE SUITABLE FOR CEMENT AND HOLLOW BRICK WALLS. (SCREW ANCHORS FOR OTHER TYPES OF WALL MUST BE SUPPLIED BY WHO SELLS OR INSTALLS THE PRODUCT).

- FIXING THE GUIDE TO THE WALL

SCREW ANCHORS SUITABLE TO FIX THE GUIDE TO THE WALL ARE NOT SUPPLIED.

THE METAL GUIDE MUST BE FIXED TO THE WALL IN A STABLE AND LEVEL WAY, FORMING A STRAIGHT LINE WHICH DOES NOT SLOPE.

IF THE FLOOR IS PERFECTLY LEVEL, THE GUIDE WILL FIT PERFECTLY AGAINST THE FLOOR; IF HOWEVER THE GUIDE ONLY RESTS IN PART ON THE FLOOR, CREATING SMALL FISSURES, IT MEANS THE FLOOR IS NOT PERFECTLY LEVEL. THE FISSURE WILL BE NOTICEABLE UNDER THE BOISERIE EVEN ONCE THE FITTING OPERATION HAS BEEN COMPLETED.

- FITTING THE COLUMNS AND PANELS

START POSITIONING A COLUMN BY FITTING THE GROOVE UNDER THE COLUMN INTO THE METAL GUIDE, THEN SLOWLY FASTEN THE COLUMN TO THE WALL.

THE COLUMN MUST BE FASTENED SLOWLY SO THAT THE PANEL NEXT TO THE COLUMN CAN BE MOUNTED AFTER HAVING FITTED THE PANEL GROOVE ONTO THE GUIDE.

THEN CONTINUE WITH ANOTHER COLUMN AND ANOTHER PANEL AND SO ON UNTIL ALL PIECES HAVE BEEN USED.

- FITTING THE HANDRAIL

ONCE ALL THE COLUMNS AND PANELS HAVE BEEN FITTED, THE HANDRAILS MUST BE FITTED ONTO THE UPPER PART OF THE PANELS.

- TIGHTEN IN A STABLE AND FIRM WAY ALL THE COLUMNS TO THE WALLS.

- FITTING THE COLUMN TOP

POSITION THE TOP ON THE COLUMN BY FITTING THE PUSH DOWN DOWEL WHICH IS UNDER THE TOP INTO THE PUSH DOWN DOWEL ON THE TOP OF THE COLUMN.

**THANKS TO THIS SIMPLE AND SPECIALLY DESIGNED SYSTEM, THE BOISERIE CAN BE
EASILY REMOVED, FOLLOWING THE SEQUENCE IN REVERSE ORDER, AND USED IN OTHER
SPACES**

DRAIN HOLE SINK TO MOUNT THE SIPHON

STANDARD

THE MINIMUM HIGHT FOR DRAIN HOLE SINK TO MOUNT THE SIPHON IS 50 CM , THE MAXIMUM HIGH MUST BE VERIFIED WITH THE FURNITURE'S TECHNICAL SCHEDULE

NO-STANDARD

FOR PARTICULAR MODELS , EHERE THE PRICE LIST SPECIFY "IMPORTANT COMPATIBLE WITH WASHBASIN OF MAXIMUM SIZE 63 – LA 64 YOU MUST INSTAL A SIPHON WITH MINIMUM SIZE UNDER 9 CM "

YOU MUST RESPECT THE DISTANCE FROM THE FLOOR FOR THE DRAIN HOLE SINK THAT WE INDICATED FOR ANY FURNITURE DEPENDING BY THE CHOSEN SIPHON S1 –S2 .

THE ALTERNATIVE, **NOT GIVEN BY "IL TEMPO DEL ..."**, YOU CAN USE A CHEAP WHITE EXTENSIBLE SPRING SIPHON .

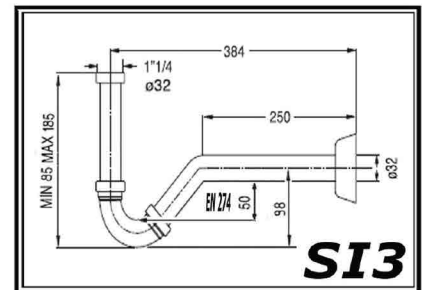
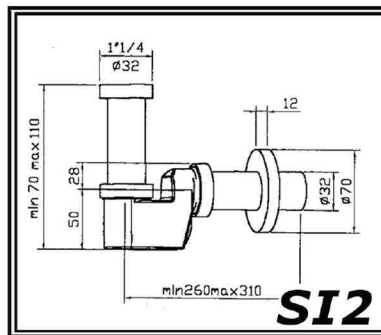
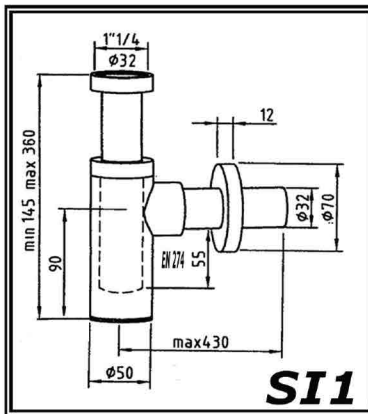

PRICE-LIST STANDARD DECORATIONS AND DECORATIONS "As you want"

Cores with mirrors and complements **without decorations** m²
 Cres with mirrors and complements **with decorations** m²

HOW IS CALCULATED THE INCREASE FOR PASTEL FINISH:

- 1) Select the model of the composition
- 2) Dimension are specified under the code's core of the chosen composition in cm (L = lenght, P = depth, H = core height)
- 3) Lenght is **MULTIPLIED** by Height, in order to calculate the **the FRONT SURFACE** of core
- 4) FRONT SURFACE in cm² is **MULTIPLIED** by the price of the selected finish (0,18 without decorations or 0,20 with decorations), in order to calculate the INCREASE for PASTEL FINISHES
- 5) The INCREASE for PASTEL FINISH calculated include all components of the chosen COMPOSITION (core, top, mirror, applique). This is the final TOTAL PRICE for the composition with **the pastel finish selected**.

ATTENTION: If the chosen composition hasn't the mirror with decorations the TOTAL PRICE is reduced by a fixed amount of

HOW TO CREATE AN ORDER

CORE WOOD CODE MO

WOOD FINISHING

WOOD COLOR FINISHING OR TWO COLOR IN CASE OF BICOLORE FINISHING

FINISHING AND COLOR FOR THE PART THAT IS NOT WOOD LIKE CAPITONNE' ,FRIEZE, RELIEF

DOOR OPENING POSITION DX - SX

CODE FOR HANDLES-PENDANT-KNOB (find the standard code on price list high-left page-position)

MIRROR CODE SP (prepared for appliques but must be drilled by the installer)

WOOD FINISHING or in CAPITONNE' the color of ECO-LEATHER standard , same as FURNITURE'S CAPITONNE'

FRAMECODE CR

FINISHING AND COLOR

APPLIQUES CODE AC

FINISHING - COLOR CO - BR - OR / FOAE - FOOR

HANG TO WALL OR ON THEFRAME

LAMPSHADE'S COLOR AND SHAPE

CERAMIC TOP CODE POCER

1HOLE-3HOLE MOUNT FOR MIXER/TAP

MARBLE TOP FOR UNDERTOP/OVERTOP WASHBASIN CODE POMA

NAME OF MARBLE

FINISHIG SHINY POLISHED - LL or ANTICATO - AT

THICKNESS CM. 2 standard - CM. 3 INCREASE + 25%

TAP HOLE : 1 HOLE or 3 HOLES

STANDARD WASHBASIN'S HOLE (in case you wanto to mount your own wasbasin let us check compatibility with our top)

WASHBASIN'S HOLE POSITION DX - SX (must be specified if it's not central CX)

UNDERTOP -OVERTOP WASHBASIN'S CODE

MARBLE TOP FOR SUPPORT WASHBASIN CODE POMA

MARBLE NAME

FINISHIG SHINY POLISHED - LL or ANTICATO - AT

THICKNESS CM. 2 standard - CM. 3 INCREASE + 25%

TAP HOLE: 1 HOLE DX -SX (must be specified if it's not central CX) OR WITHOUT HOLE because the tap is on the wall

DISTANCE FROM HOLE TO THE WALL (CM.11 tap hole CX - CM.4 tap hole DX -SX)

WASHBASIN'S HOLE DX - SX (must be specified if it's not central CX)

SUPPORT WASHBASIN CODE (if you mount your own give us tech information to verifycompatibility)

CRYSTAL TOP WITH WASHBASIN CODE POCRI

CRYSTAL COLOR

CRYSTAL FINISHING (ONDE - TINTA UNITA - GRAFFIATO)

SCRATCH COLOR (INCASE OF SCRATCH WASHBASIN)

TAP HOLE : 1 HOLE or 3 HOLES

WASHBASIN POSITION DX - SX (must be specified if it's not central CX)

CRYSTAL TOP FOR SUPPORT WASHBASIN CODE POCRI

CRYSTAL COLOR

CRYSTAL FINISHING (ONDE - TINTA UNITA - GRAFFIATO)

SCRATCH COLOR (INCASE OF SCRATCH WASHBASIN)

TAP HOLE DX - SX (specify if different from CX) or NO TAP HOLE in case of tap on the wall

DISTANCE FROM HOLE TO THE WALL (CM.11 tap hole CX - CM.4 tap hole DX -SX)

WASHBASIN'S HOLE DX - SX (must be specified if it's not central CX)

SUPPORT WASHBASIN CODE (if you mount your own give us tech information to verifycompatibility)

WOOD WINDOW CODE VT

WOOD FINISHING

WOOD COLOR FINISHING OR TWO COLOR IN CASE OF BICOLORE FINISHING

FINISHING AND COLOR FOR THE PART THAT IS NOT WOOD LIKE CAPITONNE' ,FRIEZE, RELIEF

DOOR OPENING POSITION DX - SX

CODE FOR HANDLES-PENDANT-KNOB (find the standard code on price list high-left page-position)

COMPLEMENTS CODE CD

WOOD FINISHING

WOOD COLOR FINISHING OR TWO COLOR IN CASE OF BICOLORE FINISHING

FINISHING AND COLOR FOR THE PART THAT IS NOT WOOD LIKE CAPITONNE' ,FRIEZE, RELIEF

GENERAL SALES CONDITIONS

THESE GENERAL SALES CONDITIONS GOVERN ALL SALES AGREEMENTS BETWEEN THE PARTIES. ILLUSTRATIONS, DESCRIPTIONS AND TECHNICAL CHARACTERISTICS ARE NOT BINDING AND MAY BE CHANGED WITHOUT PRIOR NOTICE.

FURTHERMORE, "IL TEMPO DEL ..." RESERVES THE RIGHT TO ALTER/UPGRADE THE PRODUCTS AS IT SEES FIT.

ORDERS – ORDERS SHALL NOT BE ACCEPTED BY PHONE. ONLY THE ORDERS SENT BY FAX OR E-MAIL SHALL BE CONSIDERED VALID. ORDERS ARE EXECUTED ACCORDING TO PRODUCT AVAILABILITY AND PARTIAL DELIVERIES MAY BE MADE.

- **BY UNDERSIGNING AN ORDER, THE CUSTOMER DECLARES TO BE AWARE OF AND TO FULLY ACCEPT THE CONDITIONS SET BY "IL TEMPO DEL ..."**

DELIVERY TERMS – DELIVERY TERMS ARE COMMUNICATED IN OUR **IMPEGNO** 2 – 3 DAYS AFTER YOUR ACCEPTANCE OF OUR QUOTE AT THE ESTABLISHED CONDITIONS.

- STANDARD DELIVERY TIMES ARE OF ABOUT 4 – 6 WEEKS FROM OUR CONFIRMATION, WHEN WE HAVE THE UNPROCESSED PRODUCTS AVAILABLE IN THE WAREHOUSE. DELIVERY TIMES CAN BE OF UP TO 8 - 9 WEEKS IF THE FINISH DOES NOT PASS OUR QUALITY CONTROL.

MAXIMUM DELIVERY TIME OF 15-16 WEEKS MAY BE NECESSARY IF THE UNPROCESSED PRODUCT IS NOT IN STOCK AND A PIECE OF FURNITURE HAS TO BE PRODUCED FROM SCRATCH.

- ANY COMMITMENT UNDERTAKEN SHALL BE RESPECTED EXCEPT IN CASES OF FORCE MAJEURE, WHEN "IL TEMPO DEL ..." HAS THE RIGHT TO CANCEL THE SALE OR EXECUTE IT AS SOON AS POSSIBLE.

- **DELIVERY TERMS ARE NOT BINDING AND ARE SUBORDINATE TO PRODUCTION CAPACITY.**

ANY DELAYS SHALL NOT GIVE THE CUSTOMER THE RIGHT TO CANCEL THE ORDER OR TO REQUEST DAMAGE COMPENSATION.

GOODS COLLECTION - THE CUSTOMER MUST COLLECT THE GOODS OR GIVE INSTRUCTIONS FOR THE DELIVERY **WITHIN 10 DAYS FROM RECEIPT OF THE NOTICE THAT THE GOODS ARE READY.** - IF THE GOODS ARE NOT COLLECTED WITHIN THE TERM ESTABLISHED, "IL TEMPO DEL ..." SHALL HAVE THE RIGHT TO INVOICE THE GOODS AND REQUEST THE PAYMENT, INCLUDING EXTRA STORAGE CHARGES.

STORAGE OF GOODS – OUR PRODUCTS MUST BE STORED **IN PREMISES WITH MEDIUM TEMPERATURE AND MEDIUM LEVEL OF HUMIDITY;** CLAIMS FOR FAULTY GOODS DUE TO INADEQUATE STORAGE OF THE GOODS OUTDOORS OR IN PREMISES WITH PARTICULARLY HIGH OR LOW TEMPERATURE AND A HIGH HUMIDITY LEVEL SHALL NOT BE ACCEPTED AS OUR PRODUCTS ARE MADE OF WOOD AND THESE CONDITIONS CAN SERIOUSLY DAMAGE THEM.

PRICES – THE PRICES ARE THOSE OF OUR PRICE LIST IN FORCE OR THOSE SPECIFIED IN OUR **PREVENTIVO** OR **IMPEGNO**.

- FOR SALES IN ITALY, THE PRICES ARE CARRIAGE PAID AND INCLUDE CARDBOARD PACKAGING FOR AMOUNTS HIGHER THAN €. 520,00, WHILE €. 35,00 ARE CHARGED FOR LOWER AMOUNTS.

- EXPORT PRICES ARE EX-WORKS (OUR PREMISES) INCLUDING CARDBOARD PACKAGING ON PALLET.

- **ALL OUR PRICES ARE VAT EXCLUDED.**

PREVENTIVO – THIS IS SENT BY OUR OFFICE AND IS **VALID ONLY IF SIGNED FOR ACCEPTANCE;** WE WILL THEN RE-CONFIRM IT WITH OUR **IMPEGNO** AND EXPECTED DELIVERY DATE.

- OUR **PREVENTIVI** ARE VALID FOR A MAXIMUM OF 30 DAYS.

IMPEGNO - THIS IS SENT BY OUR OFFICE AND IS CONSIDERED **VALID IF SIGNED FOR ACCEPTANCE OR AFTER 3 DAYS FROM THE TRANSMISSION DATE;** THE IMPEGNO CAN BE CANCELLED IN WRITING WITHIN AND NO LATER THAN 3 DAYS FROM THE TRANSMISSION DATE.

PAYMENT – THE **PAYMENT** CONDITIONS ESTABLISHED IN THE **QUOTES AND CONFIRMATIONS MUST BE STRICTLY ADHERED TO.** IT IS AGREED THAT INTEREST SHALL BE APPLIED IN THE CASE OF DELAYED PAYMENTS AT THE CURRENT OVERDRAFT INTEREST RATE.

- PAYMENT SHALL BE MADE TO OUR REGISTERED OFFICE IN A CURRENCY IN FORCE.

TITLE RETENTION – **IN COMPLIANCE WITH ART.1523 FF. OF THE ITALIAN CIVIL CODE,** TITLE TO THE GOODS SHALL REMAIN VESTED IN "IL TEMPO DEL ..." AND SHALL NOT PASS TO THE BUYER UNTIL THE PURCHASE PRICE FOR THE GOODS HAS BEEN PAID IN FULL, INCLUDING ANY INTERESTS AND ANCILLARY COSTS.

SOLVE ET REPETE – THE BUYER **CANNOT, FOR WHATEVER REASON**, INCLUDING CLAIMS, PRODUCT FAULTS OR DEFECTS, **SUSPEND OR POSTPONE PAYMENT OF THE GOODS COLLECTED**, WITHOUT PREJUDICE TO THE BUYER'S RIGHT TO RECOVER THE AMOUNT IF THE SELLER'S NON-FULFILMENT IS PROVED. **CUSTOMISED FURNITURE** – PRICES SHALL BE QUOTED BY OUR OFFICE UPON REQUEST.

CUSTOMISED FURNITURE IS UNDERSTOOD TO MEAN THE **MANUFACTURE OF MADE TO MEASURE MODELS WITH NON STANDARD SHAPE, SIZE, COLOUR AND FINISH, ALL THE MODELS OF THE I PASTELLI SERIES, WITH OR WITHOUT DECORATIONS, AND ANY MODEL WITH A NON STANDARD COLOUR.**

- FOR CUSTOMISED FURNITURE, WE REQUIRE A DOWN PAYMENT EQUAL TO 50% OF THE TOTAL AMOUNT, TO BE PAID UPON ACCEPTANCE OF THE QUOTE OR CONFIRMATION.

COMPLAINTS AND CLAIMS – COMPLAINTS AND CLAIMS SHALL NOT BE ACCEPTED FOR IMPERFECTIONS OTHER THAN THOSE DESCRIBED IN THE STANDARD FEATURES SHEET.

IT IS IMPORTANT TO CHECK THAT THE GOODS DELIVERED CORRESPOND TO THE **IMPEGNO** YOU HAVE ACCEPTED.

- **COMPLAINTS SHALL NOT BE ACCEPTED AFTER 8 DAYS** FROM THE DATE OF RECEIPT OF THE MATERIAL FOR OBVIOUS DEFECTS (SCRATCHES, DENTS, BREAKAGES, ETC.) WHICH ARE ATTRIBUTABLE TO THE PHASE FOLLOWING PRODUCT PACKAGING (TRANSPORT AND UNLOADING) AS WE CARRY OUT A STRICT QUALITY CONTROL BEFORE THE CLOSURE OF THE PACKAGING.

- **CLAIMS SHALL NOT BE ACCEPTED FOR MARBLE AND CRYSTAL PRODUCTS ONCE THE "MARBLE AND CRYSTAL INSPECTION FORM" ATTACHED TO THE TRANSPORT DOCUMENT HAS BEEN CONFIRMED AND SIGNED.**

- IN THE CASE OF **MANUFACTURING FAULTS FOUND BEFORE THE INSTALLATION OF THE PRODUCT**, A PERSON APPOINTED BY THE COMPANY (AGENT OR COMPANY MANAGER) WILL VIEW THE GOODS CONCERNED TO CHECK THE FAULT; IF THE FAULT IS CONFIRMED, WE SHALL REPLACE THE ITEM IN THE SHORTEST TIME POSSIBLE.

- **COMPLAINTS CONCERNING PRODUCTS WHICH ARE NO LONGER IN PRODUCTION SHALL NOT BE ACCEPTED** FOR ANY REASON.

- ANY OBJECTION RAISED DOES NOT JUSTIFY THE REFUSAL TO MAKE THE PAYMENT WITHIN THE TERMS AGREED; ANY DELAY IN THE PAYMENT SUSPENDS AND CANCELS THE RIGHT TO THE REPLACEMENT OF THE GOODS.

- THE DIMENSIONS IN THE PRICE LIST ARE THOSE OF THE MAXIMUM MEASUREMENTS OF THE FURNITURE, TAKING INTO ACCOUNT A MINIMUM TOLERANCE.

- **CLAIMS SHALL NOT BE ACCEPTED IF FURNITURE OR WINDOWS ARE NOT FASTENED TO THE WALL.**

- **ANY DISPUTE SHALL BE REFERRED TO THE COURT OF MODENA.**

RETURN OF GOODS NOT SUBJECT TO CLAIMS - RETURNS SHALL NOT BE ACCEPTED UNLESS AUTHORIZED BY "IL TEMPO DEL ..."; THE RETURNED **GOODS MUST BE IN PERFECT CONDITION**. THE CONDITION WILL BE ASSESSED BY OUR AGENT OR PERSON APPOINTED BY US; **PHOTOGRAPHS** OF THE GOODS BEFORE AND AFTER PACKAGING MUST BE PROVIDED TO SAFEGUARD US AND YOU IN CASE OF DAMAGE DURING TRANSPORT.

- THE GOODS MUST BE RETURNED IN THE **ORIGINAL PACKAGING OR IN THE SAME TYPE OF PACKAGING** (THICK CARDBOARD, POLYSTYRENE SHEETS, PLURIBALL OR POLYETHYLENE BAG) SUITABLE FOR TRANSPORT.

- **THE GOODS TRAVEL AT THE CUSTOMER'S RISK.**

LIABILITY – WE SHALL NOT BE LIABLE FOR DAMAGE TO PERSONS OR OBJECTS THAT MAY BE CAUSED DIRECTLY OR INDIRECTLY BY OUR PRODUCTS.

PRODUCT CLEANING - THE FOLLOWING MUST NOT BE USED TO CLEAN OUR PRODUCTS: ABRASIVE CLOTHS, ABRASIVE DETERGENTS, POLISHING LIQUIDS OR PASTES, ALCOHOL OR ACIDS IN GENERAL.

THE QUALITY OF THE MADE IN ITALY

With the terminology "**Made in Italy**" we are talking about the project of Italian product's revelation that make our products famous and appreciate all over the world.

Quality, design, style and reliability have been the most important elements that allowed Italian products to obtain an international fame, such to build a self-category in a lot of the market sectors.

IL TEMPO DEL... was born out the sign of the "**Made in Italy**" and is still a mouthpiece of this initiative only producing furniture made in Italy, using fine and qualified woods, looking for authentic styles and shapes, taking care for the details and granting the durability.

These **fundamental worth** of quality and tradition display their stark beauty and a hot elegance in every single furniture made by ...

IL TEMPO DEL...

Il tempo del...

Via Ferrari Carazzoli , 86
41042 FIORANO MODENESE - ITALY
Tel 0536/832144 - Fax 0536/910531
www.iltempodel.it - info@iltempodel.it